

PRICE-LIST '22



DESIGN PLUS



German
Design Award



A' DESIGN AWARD



winner

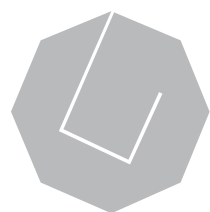

中国好设计
China Good Design



archiproducts
DESIGN AWARDS
—
WINNER 2017



FEDERLEGNOARREDO

BIOKER®
ANTIBACTERIAL + EASY-TO-CLEAN

PREZZO DI LISTINO - PUBLIC PRICE
PRIX CATALOGUE - LISTENPREIS
PRECIO DE LISTA - ЦЕНА СОГЛАСНО ПРАЙС-ЛИСТУ

115 €

APPLICABILE SU TUTTI GLI ARTICOLI IN CERAMICA A CATALOGO
AVAILABLE ON ALL CERAMIC PRODUCTS IN OUR CATALOGUE
APPLICABLE À TOUS LES ARTICLES EN CÉRAMIQUE DU CATALOGUE
AVAILABLE GILT FÜR ALLE KERAMIKPRODUKTE IM KATALOG
APLICABLE A TODOS LOS ARTÍCULOS DE CERÁMICA DEL CATÁLOGO
ПРИМЕНИМА КО ВСЕМ ТОВАРАМ ИЗ КЕРАМИКИ, ПРЕДСТАВЛЕННЫМ В КАТАЛОГЕ

CE -> (1)

SCARABEO CERAMICHE s.r.l. -> (2)
01034 Fabrica Di Roma - Vt

08 -> (3)

EN 14688 - CL 25 -> (4)

CE -> (1)

SCARABEO CERAMICHE s.r.l. -> (2)
01034 Fabrica Di Roma - Vt

07 -> (3)

EN 997 - CL 1 - 6 A -> (4)















PRICE-LIST '22



 
Hand made in Italy

ceramics index

-  = Lavabo sospeso
Wall-mounted washbasin
Lavabo suspendu
Hängewaschbecken
Lavabo suspendido
Раковина умывальника подвесная
-  = Lavabo da appoggio
Lay-on washbasin
Lavabo à poser
Aufsatzwaschbecken
Lavabo de apoio
Раковина умывальника накладная
-  = Lavabo da semincasso
Semi built-in washbasin
Lavabo semi encastré
Vorbauwaschbecken
Lavabo de semiencaje
Раковина умывальника полувстраиваемая
-  = Lavabo da incasso
Built-in washbasin
Lavabo encastré
Einbauwaschbecken
Lavabo de encaje
Раковина умывальника встраиваемая
-  = Lavabo sottopiano
Under-top washbasin
Lavabo encastré par dessus
Unterbauwaschbecken
Lavabo bajo encimera
Раковина умывальника под столешницу
-  = Lavabo a terra da appoggio
Floor-standing washbasin
Lavabo au sol
Standwaschbecken
Lavabo al suelo de apoio
Раковина умывальника напольная
-  = Wc / Bidet Sospeso
Wall-mounted WC / Bidet
Cuvette / Bidet suspendu
Hänge-WC / Bidet
Inodoro / Bidet suspendido
Унитаз / Биде подвесной
-  = Wc / Bidet a terra
Floor-mounted WC / Bidet
Cuvette / Bidet au sol
Bodenstehendes WC / Bidet
Inodoro / Bidet a tierra
Унитаз / Биде напольное
-  = Sistema di scarico ECO
ECO flushing system
Mécanisme de chasse ECO
Spülmechanismus ECO
Sistema de descarga ECO
Система смыва ECO
-  = Sistema di scarico Eco Water Saving Plus
Eco Water Saving Plus flushing system
Mécanisme de chasse Eco à économie d'eau
Spülmechanismus Eco Water Saving Plus
Sistema de descarga Eco Water Saving Plus
Система смыва Eco Water Saving Plus
-  = Sistema di scarico Clean Flush WC®
Clean Flush WC® flushing system
Mécanisme de chasse Clean Flush WC®
Spülmechanismus Clean Flush WC®
Sistema de descarga Clean Flush WC®
Система смыва Clean Flush WC®
-  = Sistema di scarico TWIST®
TWIST® flushing system
Mécanisme de chasse TWIST®
Spülmechanismus TWIST®
Sistema de descarga TWIST®
Система смыва Clean TWIST®
-  = Con cerniera rallentata - Sgancio rapido
With soft close system - Rapid lift system
Charnières avec frein de chute - Décrochage rapide
Mit sanft abgebremsten scharnieren - Schnellbefestigung
Con caída amortiguada - Desenganche rápido
С микролифтом - Быстрое отсоединение

DESIGN



cm: 42 - 50 - 70 - 90

MOON



WC-BIDET & WASHBASINS
Pag _ 6



cm: 30 - 41 - 45 - 50 - 60
80 - 100 - 120 - 141

TEOREMA 2.0 ULTRASLIM



WC-BIDET & WASHBASINS
Pag _ 18



cm: 60 - 80

TEOREMA 2.0 PLUS



WASHBASINS
Pag _ 40



cm: 22 - 33 - 39 - 40
55 - 56 - 75 - 76 - 95

GLAM



WASHBASINS
Pag _ 46



cm: 30 - 35 - 40 - 42 - 50

BUCKET



WC-BIDET & WASHBASINS
Pag _ 56



cm: 45 - 48 - 54 - 66

PLANET



WC-BIDET & WASHBASINS
Pag _ 66



cm: 51 - 55 - 71

MOAI



WC-BIDET & WASHBASINS
Pag _ 74



cm: 46 - 60

VEIL



WASHBASINS
Pag _ 80



cm: 50 - 70 - 80

FUJI



WASHBASINS
Pag _ 84



cm: 45 - 70

MIZU®



WASHBASINS
Pag _ 92



SOFT - HUNG - CUBE



cm: 24 - 30 - 38 - 40
42 - 45 - 50 - 60

WASHBASINS
Pag_ 98



THIN-LINE



cm: 40 - 45 - 55 - 63

WASHBASINS
Pag_ 104



ML



cm: 60 - 92 - 122

WASHBASINS
Pag_ 112



GAIA - THCH - MIKY



cm: 42 - 47 - 57 - 87

WASHBASINS
Pag_ 118



TEOREMA



cm: 30 - 40 - 46 - 60 - 80
100 - 120

WC-BIDET & WASHBASINS
Pag_ 124



MATTY



cm: 46 - 64

WASHBASINS
Pag_ 136



KONG



cm: 48 - 72 - 90 - 109

WASHBASINS
Pag_ 142



TSUNAMI



cm: 70 - 90

WASHBASINS
Pag_ 146



SQUARE



cm: 47 - 51 - 60

WASHBASINS
Pag_ 150



ARCO



cm: 60 - 80

WASHBASINS
Pag_ 154



ETRA



cm: 61 - 82

WASHBASINS
Pag_ 156



SEVENTY



cm: 41 - 55

WASHBASINS
Pag_ 158



NEXT



cm: 41 - 60 - 81

WASHBASINS
Pag_ 160



SHAPE



cm: 45 - 70

WASHBASINS
Pag_ 164



LAVABI D'ARREDO



cm: 30 - 37 - 40 - 48 - 87

WASHBASINS & URINAL
Pag_ 166



UP



cm: 86

KITCHEN SINK
Pag_ 172



CASTELLANA



cm: 70 - 91 - 126

WC-BIDET & WASHBASINS
Pag_ 175



BUTTERFLY



cm: 40 - 50 - 60 - 70 - 91

WC-BIDET & WASHBASINS
Pag_ 191

bathroom index

BATHROOM



SLIDE
cm: 60 - 90 - 120
Pag _ 198



ABLE
cm: 60 - 90 - 120
Pag _ 210



SOLID
cm: 80 - 100
Pag _ 216



CROSS
cm: 80 - 100
Pag _ 228



PLANA
cm: 60 - 80 - 100
Pag _ 232



FOLD
cm: 42 - 70
Pag _ 240



DIVA
cm: 42 - 70
Pag _ 244



cm: 59 - 79

FUJI
Pag _ 260



cm: 60 - 90 - 120

FRAME
Pag _ 266



cm: 60 - 90

FRAME 2.0
Pag _ 278



cm: 70 - 90 - 120 - ML

PHORMA
Pag _ 284

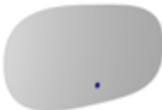

cm: 50 - 50 - 60 - 80
100 - 120

MIRROR
Pag _ 298



WALL COVERING
Pag _ 306

ACCESSORI P_ 308
ACCESSORIES
ACCESSOIRES
ZUBEHÖR
ACCESORIOS
АКСЕССУАРЫ

CONSIGLI TECNICI E SPECIFICHE P_ 314
NORMATIVA UNI EN
TECHNICAL ADVICE AND SPECIFICATIONS
NORM UNI EN
CONSEILS TECHNIQUES ET SPECIFICATIONS
NORMATIVE UNI EN
TECHNISCHE BERATUNGEN UND
SPEZIFIKATIONEN NORM UNI EN
CONSEJOS TÉCNICOS Y ESPECIFICACIONES
NORMATIVA UNI/EN
ТЕХНИЧЕСКИЕ РЕКОМЕНДАЦИИ
И СПЕЦИАЛЬНЫЕ НОРМАТИВЫ UNI EN

CONDIZIONI GENERALI DI VENDITA P_ 324
GENERAL SALES CONDITIONS
CONDITIONS GENERALES DE VENTE
ALLGEMEINE VERKAUFSBEDINGUNGEN
CONDICIONES GENERALES DE VENTA
ОБЩИЕ УСЛОВИЯ ПРОДАЖИ

ANALYTICAL INDEX P_ 330



MOON CLEAN FLUSH HUNG WC
Art. 5520/CL



MOON HUNG BIDET
Art. 5521



MOON HUNG WC
Art. 5520



MOON 45 CLEAN FLUSH HUNG WC
Art. 5524/CL



MOON WC
Art. 5522/CL



MOON BIDET
Art. 5523



MOON MONOBLOCK
CLEAN FLUSH WC
Art. 5526/CL



MOON CISTERN
Art. 5527



MOON 42 H18
Art. 5501



MOON 70 H18
Art. 5502



MOON 42 H40
Art. 5503



MOON FLOOR-STANDING
Art. 5510



MOON 42R H18
Art. 5504



MOON 70R H18
Art. 5505



MOON 90R H18
Art. 5506



MOON 50R H15
Art. 5507



MOON 70R H15
Art. 5508



MOON 90R H15
Art. 5509



MOON 42A
Art. 5511



MOON 70A
Art. 5512





MOON 45 HUNG BIDET
Art. 5525

WC BIDET ABBINABILI

MATCHING WCS AND BIDETS - WC ET BIDET COMBINABLES
KOMBINIERBARE WCS UND BIDETS - WC BIDÉ COMBINABLES
УНИТАЗЫ БИДЕ КОМБИНИРУЕМЫЕ

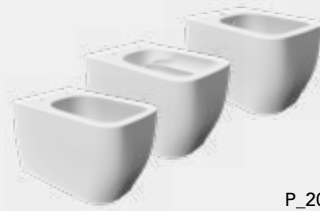

P_20

Art. 5126/TW - 52 x 36 - TWIST
Art. 5126/CL - 52 x 36 - CLEAN FLUSH
Art. 5127 - 52 x 36



P_21

Art. 5138/CL - 55 x 36 - CLEAN FLUSH
Art. 5139 - 55 x 36



P_22

Art. 5140/CL - 66 x 36 - CLEAN FLUSH
Art. 5141 - 35 x 15 - CISTERN



P_48

Art. 5201/TW - 50,5 x 36 - TWIST
Art. 5202 - 50,5 x 36



P_126

Art. 8701 - 50 x 35
Art. 8702 - 50 x 35



P_58

Art. 8812 - 53,5 x 36
Art. 8812/CL - 53,5 x 36 - CLEAN FLUSH
Art. 8813 - 53,5 x 36
Art. 8815 - 40 x 29 - KIDS WC

Art. 5520/CL

MOON CLEAN FLUSH HUNG WC - 50,5 x 36 Cm - 20 Kg



Wc Sospeso
Wall-mounted WC
Cuvette suspendue
Hänge-WC
Inodoro suspendido
Унитаз подвесной



WHITE 360,00

COLORS 595,00

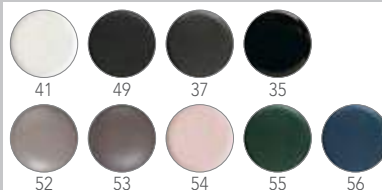

Senza staffe - Aggiungere fissaggio rapido
Without fixing set - Add quick fixing kit
Sans équerres - Ajouter fixation rapide
Ohne Befestigungselemente und Bügel - Schnellverbindung hinzufügen
Sin soportes - Añadir fijación rápida
Без скоб - Дополнительное набор быстрого монтажа

PALLET QUANTITY - 100x120x200h: 20+CW
PALLET QUANTITY - 80x120x200h: 14+CW

BIOKER + 115,00

DecorLAB 595,00



* Solo esterno
* Only external
* Seulement extérieur
* Nur extern
* Solo externo
* Только внешний

Art. 5521

MOON HUNG BIDET - 50,5 x 36 Cm - 16 Kg



Bidet sospeso
Wall-mounted bidet
Bidet suspendu
Hänge-Bidet
Bidet suspendido
Биде подвесное

WHITE 360,00

COLORS 595,00

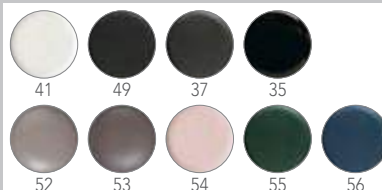

Senza staffe - Aggiungere fissaggio rapido
Borchia troppo pieno compresa
Without fixing set - Add quick fixing kit
Overflow cap included
Sans équerres - Ajouter fixation rapide
Anneau trop-plein inclus
Ohne Befestigungselemente und Bügel - Schnellverbindung hinzufügen
Beschlag für Überlaufschutz inklusive
Sin soportes - Añadir fijación rápida
Tachón rebosadero incluido
Без скоб - Дополнительное набор быстрого монтажа
Перелив входит в комплект

PALLET QUANTITY - 100x120x200h: 24
PALLET QUANTITY - 80x120x200h: 16

BIOKER + 115,00

DecorLAB 595,00



* Solo esterno
* Only external
* Seulement extérieur
* Nur extern
* Solo externo
* Только внешний

+ Art. 10050/A - STANDARD

20,00

+ Art. 10050/B - WB9 2.0 CLICK SYSTEM

25,00



Fissaggio Rapido per Sanitari
Quick fixing kit for sanitary fittings
Fixation rapide pour sanitaires
Schnellverbindung für Sanitäranlagen
Fijación rápida para sanitarios
Набор быстрого монтажа для сантехники



Fissaggio Rapido per Sanitari
Quick fixing kit for sanitary fittings
Fixation rapide pour sanitaires
Schnellverbindung für Sanitäranlagen
Fijación rápida para sanitarios
Набор быстрого монтажа для сантехники

Art. 5522/CL

MOON CLEAN FLUSH WC - 54,5 x 36 Cm - 22 Kg



Wc a terra
Floor-mounted wc
Cuvette au sol
Bodenstehendes wc
Inodoro a tierra
Унитаз напольный



WHITE 360,00

COLORS 595,00

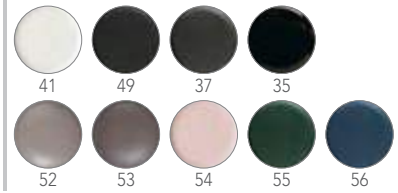

DecorLAB 595,00



* Solo esterno
* Only external
* Seulement extérieur
* Nur extern
* Solo externo
* Только внешний



Scarico traslato - Aggiungere curva tecnica
Shifted outlet - Add technical bend
Décharge déportée - Ajouter coude
Abfluss versetzt - technische Kurve hinzufügen
Desagüe desplazado - Añadir codo técnico
Слив передвижной - Дополнительное колено



PALLET QUANTITY - 100x120x200h: 15+CW
PALLET QUANTITY - 80x120x200h: 14+CW

BIOKER + 115,00

+ Art. 10014

40,00



Curva tecnica per Wc Art. 5522/CL - 160 / 170 mm
Technical plastic curve for wc Art. 5522/CL - 160 / 170 mm
Pipe coudée pour cuvette Art. 5522/CL - 160 / 170 mm
wc-anschlussbogen Art. 5522/CL - 160 / 170 mm
Curva técnica para inodoro Art. 5522/CL - 160 / 170 mm
Колено сливное для унитаза Art. 5522/CL - 160 / 170 mm

+ Art. 10014/A

40,00



Curva tecnica per Wc Art. 5522/CL - 60 / 160 mm
Technical plastic curve for wc Art. 5522/CL - 60 / 160 mm
Pipe coudée pour cuvette Art. 5522/CL - 60 / 160 mm
wc-anschlussbogen Art. 5522/CL - 60 / 160 mm
Curva técnica para inodoro Art. 5522/CL - 60 / 160 mm
Колено сливное для унитаза Art. 5522/CL - 60 / 160 mm

+ Art. 10014/B

40,00



Curva tecnica per Wc Art. 5522/CL - 170 / 215 mm
Technical plastic curve for wc Art. 5522/CL - 170 / 215 mm
Pipe coudée pour cuvette Art. 5522/CL - 170 / 215 mm
wc-anschlussbogen Art. 5522/CL - 170 / 210 mm
Curva técnica para inodoro Art. 5522/CL - 170 / 215 mm
Колено сливное для унитаза Art. 5522/CL - 170 / 215 mm

+ Art. 10028

17,00



Eccentrico - 345 ± 15 mm
Eccentric - 345 ± 15 mm
Excentrique - 345 ± 15 mm
Exzentrisch - 345 ± 15 mm
Excéntrico - 345 ± 15 mm
Эксцентрик - 345 ± 15 mm

Art. 5523

MOON BIDET - 54,5 x 36 Cm - 22 Kg



Bidet a terra
Floor-mounted bidet
Bidet au sol
Bodenstehendes Bidet
Bidet a tierra
Биде напольное

WHITE 360,00

COLORS 595,00

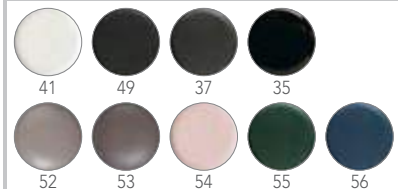

DecorLAB 595,00



* Solo esterno
* Only external
* Seulement extérieur
* Nur extern
* Solo externo
* Только внешний



Borchia troppo pieno compresa
Overflow cap included
Anneau trop-plein inclus
Beschlag für Überlaufschutz inklusive
Tachón rebosadero incluido
Перелив входит в комплект



PALLET QUANTITY - 100x120x200h: 20
PALLET QUANTITY - 80x120x200h: 16

BIOKER + 115,00

Art. 5526/CL

MOON CLEAN FLUSH MONOBLOCK - 66 x 36 Cm - 30 Kg



Wc monoblocco
Monoblock WC
Cuvette monobloc
WC-Kombination
Inodoro monobloque
Моноблочный унитаз



WHITE

540,00



PALLET QUANTITY - 100x120x200h: 9+CW+CASS
PALLET QUANTITY - 80x120x200h: 6+CW+CASS

BIOKER + 115,00

Art. 5527

MOON CISTERN - 36 x 15 Cm - 14 Kg

Cassetta per Art. 5526
Wall cistern for Art. 5526
Réservoir de chasse pour Art. 5526
Spülkasten Für Art. 5526
Cisterna Para Art. 5526
бачок для Art. 5526

WHITE

170,00



Art. 10022

115,00

Sistema di scarico per Art. 5527
Flushing system for Art. 5527
Système de chasse pour Art. 5527
Ablaufsystem Für Art. 5527
Sistema De Descarga Para Art. 5527
Система слива для арт. 5527



Entrata acqua sotto a destra da 1/2"
Right hand bottom 1/2" inch inlet
Entrée eau en bas à droite 1/2 pouce
Wassereinlauf unten rechts mit 1/2 Zoll
Entrada de agua inferior derecha de 1/2"
Вход воды снизу справа, 1/2"

Art. 5524/CL

MOON 45 CLEAN FLUSH HUNG WC - 45 x 35 Cm - 20 Kg



Wc Sospeso
Wall-mounted WC
Cuvette suspendue
Hänge-WC
Inodoro suspendido
Унитаз подвесной



WHITE 360,00

COLORS 595,00

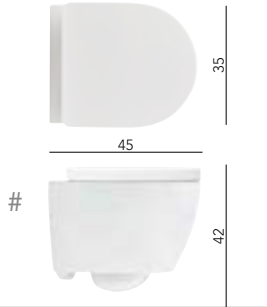
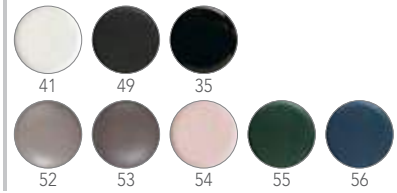

Senza staffe - Aggiungere fissaggio rapido
Without fixing set - Add quick fixing kit
Sans équerres - Ajouter fixation rapide
Ohne Befestigungselemente und Bügel - Schnellverbindung hinzufügen
Sin soportes - Añadir fijación rápida
Без скоб - Дополнительное набор быстрого монтажа

PALLET QUANTITY - 100x120x200h: 20+CW
PALLET QUANTITY - 80x120x200h: 14+CW

BIOKER + 115,00

Art. 5525

MOON 45 HUNG BIDET - 45 x 35 Cm - 15,5 Kg



Bidet sospeso
Wall-mounted bidet
Bidet suspendu
Hänge-Bidet
Bidet suspendido
Биде подвесное

WHITE 360,00

COLORS 595,00

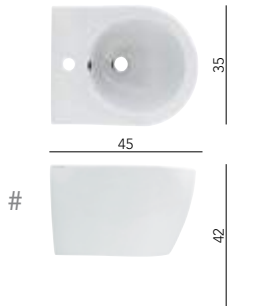
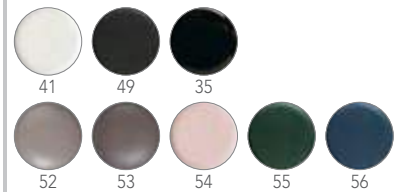

Senza staffe - Aggiungere fissaggio rapido
Borchia troppo pieno compresa
Without fixing set - Add quick fixing kit
Overflow cap included
Sans équerres - Ajouter fixation rapide
Anneau trop-plein inclus
Ohne Befestigungselemente und Bügel - Schnellverbindung hinzufügen
Beschlag für Überlaufschutz inklusive
Sin soportes - Añadir fijación rápida
Tachón rebosadero incluido
Без скоб - Дополнительное набор быстрого монтажа
Перелив входит в комплект

PALLET QUANTITY - 100x120x200h: 24
PALLET QUANTITY - 80x120x200h: 16

BIOKER + 115,00

+ Art. 10050/A - STANDARD

20,00

+ Art. 10050/B - WB9 2.0 CLICK SYSTEM

25,00



Fissaggio Rapido per Sanitari
Quick fixing kit for sanitary fittings
Fixation rapide pour sanitaires
Schnellverbindung für Sanitäranlagen
Fijación rápida para sanitarios
Набор быстрого монтажа для сантехники



Fissaggio Rapido per Sanitari
Quick fixing kit for sanitary fittings
Fixation rapide pour sanitaires
Schnellverbindung für Sanitäranlagen
Fijación rápida para sanitarios
Набор быстрого монтажа для сантехники

Art. 5530/A**MOON SLIM SEAT COVER**

Per - For - Pour - Für - Para - Для:
Art.: 5520/CL - 5520 - 5522/CL - 5526/CL

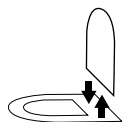
**Sedile per Wc in termoindurente**

Seat cover Wc in termosetting resin
Abattant wc en matière thermodurcissable
WC-deckel Duroplas
Asiento para inodoro en material termoenduracido
Сиденье унитаза из термореактивного полимера

Con cerniere cromate - Sgancio rapido
With chromed Kit - Rapid lift system
Charnières chromées - Décrochage rapide
Mit scharniere chrom - Schnellbefestigung
Bisagras cromadas - Desenganche rápido
С хромированными шарнирами - Быстрое отсоединение

WHITE**140,00****Art. 5530/B****MOON SLIM SEAT COVER**

Per - For - Pour - Für - Para - Для:
Art.: 5520/CL - 5520 - 5522/CL - 5526/CL

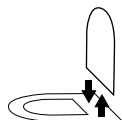
**Sedile per Wc in termoindurente**

Seat cover Wc in termosetting resin
Abattant wc en matière thermodurcissable
WC-deckel Duroplas
Asiento para inodoro en material termoenduracido
Сиденье унитаза из термореактивного полимера

Con cerniera rallentata - Sgancio rapido
With soft close system - Rapid lift system
Charnieres avec frein de chute - Décrochage rapide
Mit sanft abgebremsten scharnieren - Schnellbefestigung
Con caída amortiguada - Desenganche rápido
С микролифтом - Быстрое отсоединение

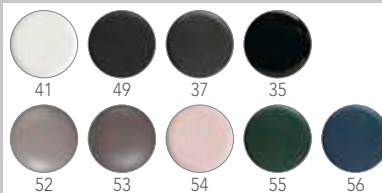
WHITE**185,00****COLORS****260,00****Art. 5526/A****MOON 45 SEAT COVER**

Per - For - Pour - Für - Para - Для:
Art.: 5524/CL

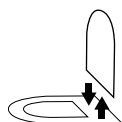
**Sedile per Wc in termoindurente**

Seat cover Wc in termosetting resin
Abattant wc en matière thermodurcissable
WC-deckel Duroplas
Asiento para inodoro en material termoenduracido
Сиденье унитаза из термореактивного полимера

Con cerniere cromate - Sgancio rapido
With chromed Kit - Rapid lift system
Charnières chromées - Décrochage rapide
Mit scharniere chrom - Schnellbefestigung
Bisagras cromadas - Desenganche rápido
С хромированными шарнирами - Быстрое отсоединение

WHITE**140,00****Art. 5526/B****MOON 45 SEAT COVER**

Per - For - Pour - Für - Para - Для:
Art.: 5524/CL

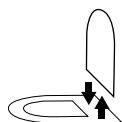
**Sedile per Wc in termoindurente**

Seat cover Wc in termosetting resin
Abattant wc en matière thermodurcissable
WC-deckel Duroplas
Asiento para inodoro en material termoenduracido
Сиденье унитаза из термореактивного полимера

Con cerniera rallentata - Sgancio rapido
With soft close system - Rapid lift system
Charnieres avec frein de chute - Décrochage rapide
Mit sanft abgebremsten scharnieren - Schnellbefestigung
Con caída amortiguada - Desenganche rápido
С микролифтом - Быстрое отсоединение

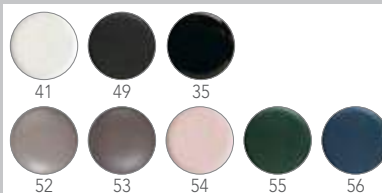
WHITE**185,00****COLORS****260,00****Art. 10005****FIXING SET****Staffe di montaggio Wc e bidet**

Fixing attachments for Wc and bidet
Supports de montage pour cuvette et bidets suspendus
Montagebügel Für Hänge-wc und bidet
Soportes de montaje inodoro y bidé
Монтажные кронштейны для унитаза и биде

--**70,00**

Art. 5501

MOON 42 H18 - 42 x 42 Cm - 12 Kg - 8 L.



Lavabo da appoggio
Lay-on washbasin
Lavabo à poser
Aufsatzwaschbecken
Lavabo de apojo
Раковина умывальника накладная



Senza troppo pieno - Consigliata piletta Art. 10034
Without overflow - Waste Art. 10034 recommended
Sans trop-plein - Bonde Art. 10034 conseillée
Ohne überlauf - Abfluss Art. 10034 empfohlen
Sin rebosadero - Recomendado desagüe Art. 10034
Без пробки перелива - Рекомендуется донный клапан арт. 10034

PALLET QUANTITY - 100x120x200h: 50
PALLET QUANTITY - 80x120x200h: 28

BIOKER + 115,00

WHITE 370,00

COLORS 570,00

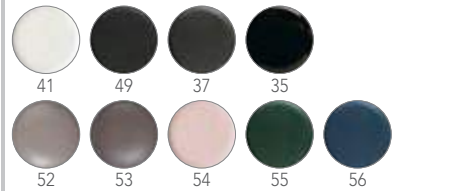

DecorLAB - DecorART 600,00



Art. 5502

MOON 70 H18 - 72 x 42 Cm - 17 Kg - 16 L.



Lavabo da appoggio
Lay-on washbasin
Lavabo à poser
Aufsatzwaschbecken
Lavabo de apojo
Раковина умывальника накладная

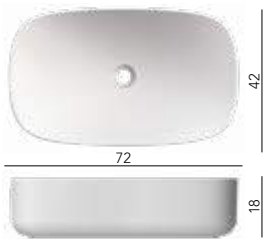

Senza troppo pieno - Consigliata piletta Art. 10034
Without overflow - Waste Art. 10034 recommended
Sans trop-plein - Bonde Art. 10034 conseillée
Ohne überlauf - Abfluss Art. 10034 empfohlen
Sin rebosadero - Recomendado desagüe Art. 10034
Без пробки перелива - Рекомендуется донный клапан арт. 10034

PALLET QUANTITY - 100x120x200h: 31
PALLET QUANTITY - 80x120x200h: 26

BIOKER + 115,00

WHITE 490,00

COLORS 695,00

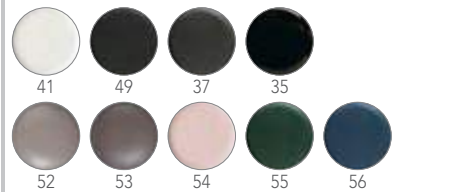

DecorART 700,00



Art. 5503

MOON 42 H40 - 42 x 42 Cm - 17 Kg - 13 L.



Lavabo da appoggio
Lay-on washbasin
Lavabo à poser
Aufsatzwaschbecken
Lavabo de apojo
Раковина умывальника накладная

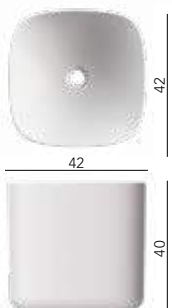

Senza troppo pieno - Consigliata piletta Art. 10034
Without overflow - Waste Art. 10034 recommended
Sans trop-plein - Bonde Art. 10034 conseillée
Ohne überlauf - Abfluss Art. 10034 empfohlen
Sin rebosadero - Recomendado desagüe Art. 10034
Без пробки перелива - Рекомендуется донный клапан арт. 10034

PALLET QUANTITY - 100x120x200h: 16
PALLET QUANTITY - 80x120x200h: 8

BIOKER + 115,00

WHITE 490,00

COLORS 695,00

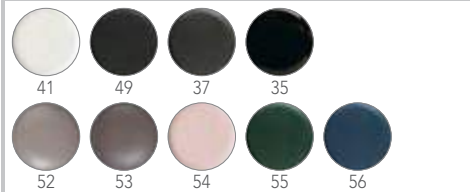

DecorART 700,00

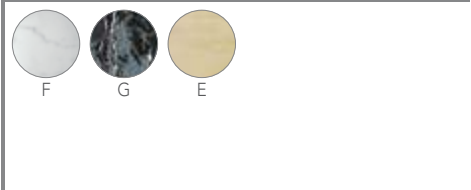

Art. 5504

MOON 42R H18 - 42 x 42 Cm - 12 Kg - 5 L.



Lavabo da appoggio
Lay-on washbasin
Lavabo à poser
Aufsatzwaschbecken
Lavabo de apoyo
Раковина умывальника накладная



Senza troppo pieno - Consigliata piletta Art. 10034
Without overflow - Waste Art. 10034 recommended
Sans trop-plein - Bonde Art. 10034 conseillée
Ohne überlauf - Abfluss Art. 10034 empfohlen
Sin rebosadero - Recomendado desagüe Art. 10034
Без пробки перелива - Рекомендуется донный клапан арт. 10034

PALLET QUANTITY - 100x120x200h: 50
PALLET QUANTITY - 80x120x200h: 28

BIOKER + 115,00

WHITE 390,00

COLORS 570,00

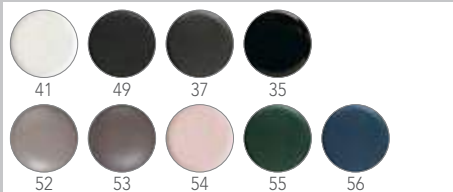

DecorLAB - DecorART 600,00



Art. 5505

MOON 70R H18 - 72 x 42 Cm - 17 Kg - 9 L.



Lavabo da appoggio
Lay-on washbasin
Lavabo à poser
Aufsatzwaschbecken
Lavabo de apoyo
Раковина умывальника накладная



Senza troppo pieno - Consigliata piletta Art. 10034
Without overflow - Waste Art. 10034 recommended
Sans trop-plein - Bonde Art. 10034 conseillée
Ohne überlauf - Abfluss Art. 10034 empfohlen
Sin rebosadero - Recomendado desagüe Art. 10034
Без пробки перелива - Рекомендуется донный клапан арт. 10034

PALLET QUANTITY - 100x120x200h: 28
PALLET QUANTITY - 80x120x200h: 26

BIOKER + 115,00

WHITE 490,00

COLORS 695,00

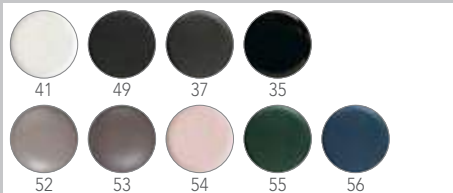

DecorART 700,00



Art. 5506

MOON 90R H18 - 90 x 42 Cm - 20 Kg - 12 L.



Lavabo da appoggio
Lay-on washbasin
Lavabo à poser
Aufsatzwaschbecken
Lavabo de apoyo
Раковина умывальника накладная



Senza troppo pieno - Consigliata piletta Art. 10034
Without overflow - Waste Art. 10034 recommended
Sans trop-plein - Bonde Art. 10034 conseillée
Ohne überlauf - Abfluss Art. 10034 empfohlen
Sin rebosadero - Recomendado desagüe Art. 10034
Без пробки перелива - Рекомендуется донный клапан арт. 10034

PALLET QUANTITY - 100x120x200h: 20
PALLET QUANTITY - 80x120x200h: 13

BIOKER + 115,00

WHITE 620,00

COLORS 820,00

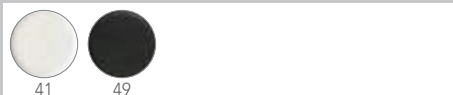

Art. 5507

MOON 50R H15 - 50 x 45 Cm - 12 Kg - 2,5 L.



Lavabo da appoggio o sospeso

Lay-on or wall-mounted washbasin

Lavabo à poser ou suspendu

Aufsatz-oder Hängewaschbecken

Lavabo de apoyo o suspendido

Раковина умывальника накладная или подвесная

#



Fissaggi a muro compresi - Borchia troppo pieno compresa

Wall attachments included - Overflow cap included

Fixations murales incluses - Anneau trop-plein inclus

Wandbefestigungen inklusive - Beschlag für Überlaufschutz inklusive

Fijación pared incluida - Tachón rebosadero incluido

Настенные крепления входят в комплект - Перелив входит в комплект

PALLET QUANTITY - 100x120x200h: 50

PALLET QUANTITY - 80x120x200h: 28

BIOKER + 115,00

WHITE

435,00

COLORS

640,00



DecorLAB - DecorART

670,00



Art. 5508

MOON 70R H15 - 70 x 45 Cm - 17 Kg - 3,5 L.



Lavabo da appoggio o sospeso

Lay-on or wall-mounted washbasin

Lavabo à poser ou suspendu

Aufsatz-oder Hängewaschbecken

Lavabo de apoyo o suspendido

Раковина умывальника накладная или подвесная

#



Fissaggi a muro compresi - Borchia troppo pieno compresa

Wall attachments included - Overflow cap included

Fixations murales incluses - Anneau trop-plein inclus

Wandbefestigungen inklusive - Beschlag für Überlaufschutz inklusive

Fijación pared incluida - Tachón rebosadero incluido

Настенные крепления входят в комплект - Перелив входит в комплект

PALLET QUANTITY - 100x120x200h: 30

PALLET QUANTITY - 80x120x200h: 28

BIOKER + 115,00

WHITE

480,00

COLORS

680,00



Art. 5509

MOON 90R H15 - 90 x 45 Cm - 21 Kg - 5 L.



Lavabo da appoggio o sospeso

Lay-on or wall-mounted washbasin

Lavabo à poser ou suspendu

Aufsatz-oder Hängewaschbecken

Lavabo de apoyo o suspendido

Раковина умывальника накладная или подвесная

#

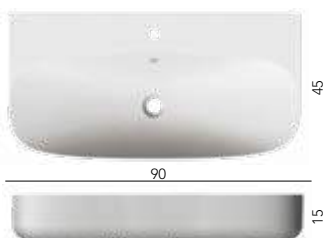

Fissaggi a muro compresi - Borchia troppo pieno compresa

Wall attachments included - Overflow cap included

Fixations murales incluses - Anneau trop-plein inclus

Wandbefestigungen inklusive - Beschlag für Überlaufschutz inklusive

Fijación pared incluida - Tachón rebosadero incluido

Настенные крепления входят в комплект - Перелив входит в комплект

PALLET QUANTITY - 100x120x200h: 20

PALLET QUANTITY - 80x120x200h: 13

BIOKER + 115,00

WHITE

590,00

COLORS

790,00

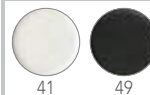

Art. 5510

MOON FLOOR-STANDING - 42 x 42 x H85 Cm - 45 Kg - 14 L.

85

Lavabo a terra da appoggio

Floor-standing washbasin

Lavabo au sol

Standwaschbecken

Lavabo al suelo de apoyo

Раковина умывальника напольная

WHITE**1.950,00****COLORS****2.550,00**

41

49

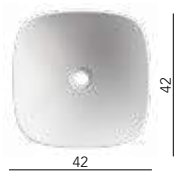

42

42

Senza troppo pieno - Sifone e raccordo in plastica incluso

Without overflow - Plastic trap and fitting included

Sans trop-plein - Siphon et raccord en plastique inclus

Ohne überlauf - Siphon und anschluss aus kunststoff mitgeliefert

Sin rebosadero - Sifón y unión in plástico incluyendo

Без пробки перелива - Пластиковые сифон и патрубков входят в комплект

PALLET QUANTITY - 100x120x200h: 6

PALLET QUANTITY - 80x120x200h: 3

BIOKER + 115,00

Art. 5531

MOON TOWEL BAR

Porta asciugamani

Towel bar

Porte-Serviettes

Handtuchhalter

Toallero

Держатель полотенец

--

96,00

Art. 5511	MOON 42A - 42 x 42 Cm - 12 Kg - 2,5 L.	WHITE 355,00
	<p>Lavabo da incasso Built-in washbasin Lavabo encastré Einbauwaschbecken Lavabo de encaje Раковина умывальника встраиваемая</p>	<p>COLORS 560,00</p> 
	<p>Senza troppo pieno - Consigliata piletta Art. 10034 Without overflow - Waste Art. 10034 recommended Sans trop-plein - Bonde Art. 10034 conseillée Ohne überlauf - Abfluss Art. 10034 empfohlen Sin rebosadero - Recomendado desagüe Art. 10034 Без пробки перелива - Рекомендуется донный клапан арт. 10034</p> <p>PALLET QUANTITY - 100x120x200h: 50 PALLET QUANTITY - 80x120x200h: 28</p> <p>BIOKER + 115,00</p>	<p>DecorLAB - DecorART 600,00</p> 

Art. 5512	MOON 70A - 72 x 42 Cm - 16 Kg - 5 L.	WHITE 445,00
	<p>Lavabo da incasso Built-in washbasin Lavabo encastré Einbauwaschbecken Lavabo de encaje Раковина умывальника встраиваемая</p>	<p>COLORS 650,00</p> 
	<p>Senza troppo pieno - Consigliata piletta Art. 10034 Without overflow - Waste Art. 10034 recommended Sans trop-plein - Bonde Art. 10034 conseillée Ohne überlauf - Abfluss Art. 10034 empfohlen Sin rebosadero - Recomendado desagüe Art. 10034 Без пробки перелива - Рекомендуется донный клапан арт. 10034</p> <p>PALLET QUANTITY - 100x120x200h: 28 PALLET QUANTITY - 80x120x200h: 26</p> <p>BIOKER + 115,00</p>	<p>DecorART 680,00</p> 

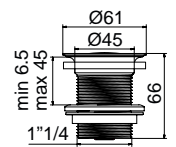
Art. 10034		CR 200,00
	<p>Piletta lavabo da 1"1/4 con troppo pieno integrato 1"1/4 washbasin waste with overflow Bonde lavabo de 1"1/4 avec trop-plein intégré Waschbeckenabfluss 1"1/4 mit integriertem Überlaufschutz Desagüe lavabo de 1"1/4 con rebosadero integrado Донный клапан для умывальника 1"1/4 с интегрированным переливом</p>	<p>NROP 220,00</p> 

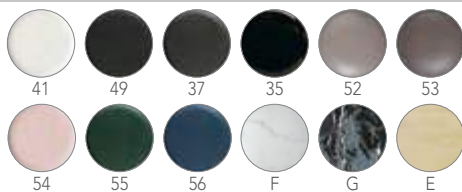
Art. 10010/C		CR / NROP + WHITE 105,00
	<p>Scarico automatico 1"1/4 click-clack, tappo grande Automatic pop-waste 1" 1/4 click-clack, big plug Bonde clic-clac, grand debit Automatischer ablauf click-clack, crosser stöpsel Valvula automática 1" 1/4 click-clack, tapón grande Слив автоматический: клапан 1"1/4, большая пробка</p>	<p>ORS + WHITE 145,00 CR / NROP + COLORS 130,00 ORS + COLORS 175,00</p> 



TEOREMA 2.0
TWIST HUNG WC
Art. 5126/TW



TEOREMA 2.0
CLEAN FLUSH HUNG WC
Art. 5126/CL



TEOREMA 2.0
HUNG BIDET
Art. 5127



TEOREMA 2.0
CLEAN FLUSH WC
Art. 5138/CL



TEOREMA 2.0 CISTERN
Art. 5141



TEOREMA 2.0 60
Art. 5101



TEOREMA 2.0 80
Art. 5102



TEOREMA 2.0 41R
Art. 5129



TEOREMA 2.0 50
Art. 5111



TEOREMA 2.0 50AP
Art. 5112



TEOREMA 2.0 60X38,5R
Art. 5156



TEOREMA 2.0 46R
Art. 5104



TEOREMA 2.0 60 SHELF SX®
Art. 5117



TEOREMA 2.0 80R
Art. 5110



TEOREMA 2.0 80 SHELF DX®
Art. 5115



TEOREMA 2.0 80 SHELF SX®
Art. 5118



TEOREMA 2.0 100 SHELF DX®
Art. 5119



TEOREMA 2.0 100 SHELF SX®
Art. 5120



TEOREMA 2.0 100 DOUBLE SHELF®
Art. 5124



TEOREMA 2.0 101x46
Art. 5142



TEOREMA 2.0 120 SHELF SX®
Art. 5122



TEOREMA 2.0 120 DOUBLE SHELF®
Art. 5125



TEOREMA 2.0 121x46
Art. 5143



TEOREMA 2.0 141x46
Art. 5116



TEOREMA 2.0 45x36 / 45x36S
Art. 5130
Art. 5134



TEOREMA 2.0 60x36 / 60x36S
Art. 5131
Art. 5135



TEOREMA 2.0 80x36 / 80x36S
Art. 5132
Art. 5136



TEOREMA 2.0 100x36 / 100x36S
Art. 5133
Art. 5137

WC BIDET ABBINABILI

MATCHING WCS AND BIDETS - WC ET BIDET COMBINABLES
 KOMBINIERBARE WCS UND BIDETS - WC BIDÉ COMBINABLES
 УНИТАЗЫ БИДЕ КОМБИНИРУЕМЫЕ



TEOREMA 2.0
 BIDET
 Art. 5139



TEOREMA 2.0 MONOBLOCK
 CLEAN FLUSH MONOBLOCK WC
 Art. 5140/CL



TEOREMA 2.0 30R
 Art. 5155



TEOREMA 2.0 60R
 Art. 5105



TEOREMA 2.0 60 SHELF DX®
 Art. 5114



TEOREMA 2.0 80 DOUBLE SHELF®
 Art. 5123



TEOREMA 2.0 100R
 Art. 5106/R-100/A
 Art. 5106/R-100/B



TEOREMA 2.0 120R
 Art. 5107/R-120/A
 Art. 5107/R-120/B



TEOREMA 2.0 120 SHELF DX®
 Art. 5121



TEOREMA 2.0 45A BUILT-IN
 Art. 5108



TEOREMA 2.0 60A BUILT-IN
 Art. 5109



TEOREMA 2.0 120x36 / 120x36S
 Art. 5153
 Art. 5154



CONSOLE



TOWEL BAR



P_8

Art. 5520/CL - 50,5 x 36 - CLEAN FLUSH
 Art. 5521 - 50,5 x 36



P_11

Art. 5524/CL - 45 x 35 - CLEAN FLUSH
 Art. 5525 - 45 x 35



P_9

Art. 5522 - 54,5 x 36
 Art. 5522/CL - 54,5 x 36 - CLEAN FLUSH
 Art. 5523 - 54,5 x 36



P_10

Art. 5526/CL - 66 x 36 - CLEAN FLUSH
 Art. 5527 - 36 x 15 - CISTERN



P_48

Art. 5201/TW - 50,5 x 36 - TWIST
 Art. 5202 - 50,5 x 36



P_126

Art. 8701 - 50 x 35
 Art. 8702 - 50 x 35



P_58

Art. 8812 - 53,5 x 36
 Art. 8812/CL - 53,5 x 36 - CLEAN FLUSH
 Art. 8813 - 53,5 x 36
 Art. 8815 - 40 x 29 - KIDS WC



Art. 5126/TW

TEOREMA 2.0 TWIST HUNG WC - 52 x 36 Cm - 24,5 Kg

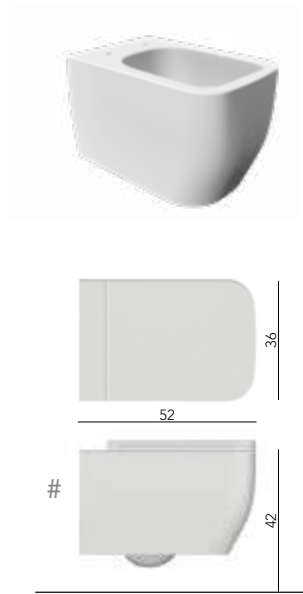

Wc Sospeso
Wall-mounted WC
Cuvette suspendue
Hänge-WC
Inodoro suspendido
Унитаз подвесной



WHITE 450,00

COLORS 700,00

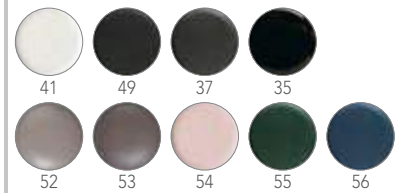

BICOLORS 800,00

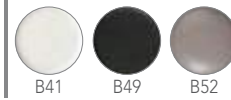

Senza staffe - Aggiungere fissaggio rapido
Without fixing set - Add quick fixing kit
Sans équerres - Ajouter fixation rapide
Ohne Befestigungselemente und Bügel - Schnellverbindung hinzufügen
Sin soportes - Añadir fijación rápida
Без скоб - Дополнительное набор быстрого монтажа

PALLET QUANTITY - 100x120x200h: 20+CW
PALLET QUANTITY - 80x120x200h: 14+CW

BIOKER + 115,00

Art. 5126/CL

TEOREMA 2.0 CLEAN FLUSH HUNG WC - 52 x 36 Cm - 24,5 Kg

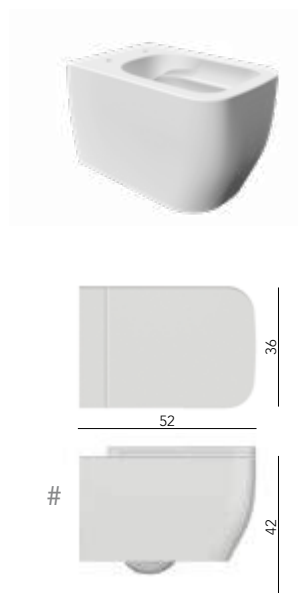

Wc Sospeso
Wall-mounted WC
Cuvette suspendue
Hänge-WC
Inodoro suspendido
Унитаз подвесной



WHITE 360,00

COLORS 595,00

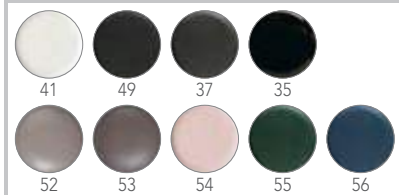

Senza staffe - Aggiungere fissaggio rapido
Without fixing set - Add quick fixing kit
Sans équerres - Ajouter fixation rapide
Ohne Befestigungselemente und Bügel - Schnellverbindung hinzufügen
Sin soportes - Añadir fijación rápida
Без скоб - Дополнительное набор быстрого монтажа

PALLET QUANTITY - 100x120x200h: 20+CW
PALLET QUANTITY - 80x120x200h: 14+CW

BIOKER + 115,00

Art. 5127

TEOREMA 2.0 HUNG BIDET - 52 x 36 Cm - 20 Kg

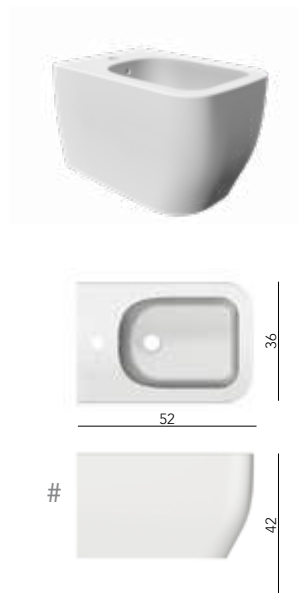

Bidet sospeso
Wall-mounted bidet
Bidet suspendu
Hänge-Bidet
Bidet suspendido
Биде подвесное

WHITE 360,00

COLORS 595,00

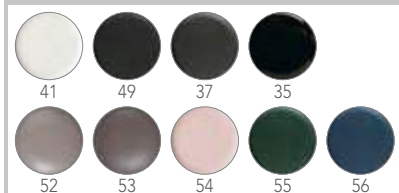

Senza staffe - Aggiungere fissaggio rapido
Borchia troppo pieno compresa
Without fixing set - Add quick fixing kit
Overflow cap included
Sans équerres - Ajouter fixation rapide
Anneau trop-plein inclus
Ohne Befestigungselemente und Bügel - Schnellverbindung hinzufügen
Beschlag für Überlaufschutz inklusive
Sin soportes - Añadir fijación rápida
Tachón rebosadero incluido
Без скоб - Дополнительное набор быстрого монтажа
Перелив входит в комплект

PALLET QUANTITY - 100x120x200h: 24
PALLET QUANTITY - 80x120x200h: 16

BIOKER + 115,00

+ Art. 10050/A - STANDARD 20,00

20,00

+ Art. 10050/B - WB9 2.0 CLICK SYSTEM 25,00

25,00



Fissaggio Rapido per Sanitari
 Quick fixing kit for sanitary fittings
 Fixation rapide pour sanitaires
 Schnellverbindung für Sanitäreanlagen
 Fijación rápida para sanitarios
 Набор быстрого монтажа для сантехники



Fissaggio Rapido per Sanitari
 Quick fixing kit for sanitary fittings
 Fixation rapide pour sanitaires
 Schnellverbindung für Sanitäreanlagen
 Fijación rápida para sanitarios
 Набор быстрого монтажа для сантехники

Art. 5138/CL **TEOREMA 2.0 CLEAN FLUSH WC** - 55 x 36 Cm - 26 Kg



Wc a terra
 Floor-mounted wc
 Cuvette au sol
 Bodenstehendes wc
 Inodoro a tierra
 Унитаз напольный



WHITE 360,00



COLORS 595,00

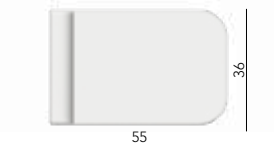
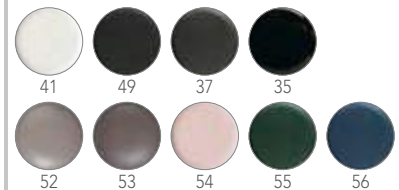

Scarico traslato - Aggiungere curva tecnica
 Shifted outlet - Add technical bend
 Décharge déportée - Ajouter coude
 Abfluss versetzt - technische Kurve hinzufügen
 Desagüe desplazado - Añadir codo técnico
 Слив передвижной - Дополнительное колено



PALLET QUANTITY - 100x120x200h: 15+CW
 PALLET QUANTITY - 80x120x200h: 14+CW

BIOKER + 115,00

+ Art. 10014 40,00

40,00

+ Art. 10014/A 40,00

40,00



Curva tecnica per Wc Art. 5138/CL - 160 / 170 mm
 Technical plastic curve for wc Art. 5138/CL - 160 / 170 mm
 Pipe coudée pour cuvette Art. 5138/CL - 160 / 170 mm
 wc-anschlussbogen Art. 5138/CL - 160 / 170 mm
 Curva técnica para inodoro Art. 5138/CL - 160 / 170 mm
 Колено сливное для унитаза Art. 5138/CL - 160 / 170 mm



Curva tecnica per Wc Art. 5138/CL - 60 / 160 mm
 Technical plastic curve for wc Art. 5138/CL - 60 / 160 mm
 Pipe coudée pour cuvette Art. 5138/CL - 60 / 160 mm
 wc-anschlussbogen Art. 5138/CL - 60 / 160 mm
 Curva técnica para inodoro Art. 5138/CL - 60 / 160 mm
 Колено сливное для унитаза Art. 5138/CL - 60 / 160 mm

+ Art. 10014/B 40,00

40,00

+ Art. 10028 17,00

17,00



Curva tecnica per Wc Art. 5138/CL - 170 / 215 mm
 Technical plastic curve for wc Art. 5138/CL - 170 / 215 mm
 Pipe coudée pour cuvette Art. 5138/CL - 170 / 215 mm
 wc-anschlussbogen Art. 5522/CL - 5138 / 210 mm
 Curva técnica para inodoro Art. 5138/CL - 170 / 215 mm
 Колено сливное для унитаза Art. 5138/CL - 170 / 215 mm



Eccentrico - 345 ± 15 mm
 Eccentric - 345 ± 15 mm
 Excentrique - 345 ± 15 mm
 Exzentrisch - 345 ± 15 mm
 Excéntrico - 345 ± 15 mm
 Эксцентрик - 345 ± 15 mm

Art. 5139

TEOREMA 2.0 BIDET - 55 x 36 Cm - 26 Kg



Bidet a terra
Floor-mounted bidet
Bidet au sol
Bodenstehendes Bidet
Bidet a tierra
Биде напольное

WHITE 360,00

COLORS 595,00

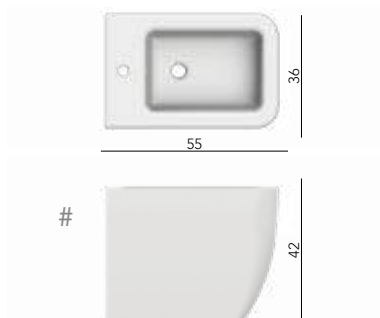
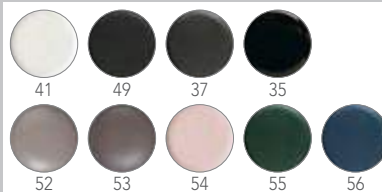

Borchia troppo pieno compresa
Overflow cap included
Anneau trop-plein inclus
Beschlag für Überlaufschutz inklusive
Tachón rebosadero incluido
Перелив входит в комплект

PALLET QUANTITY - 100x120x200h: 20
PALLET QUANTITY - 80x120x200h: 16

BIOKER + 115,00

Art. 5140/CL

TEOREMA 2.0 CLEAN FLUSH MONOBLOCK - 66 x 36 Cm - 39 Kg



Wc monoblocco
Monoblock WC
Cuvette monobloc
WC-Kombination
Inodoro monobloque
Моноблочный унитаз



WHITE 540,00

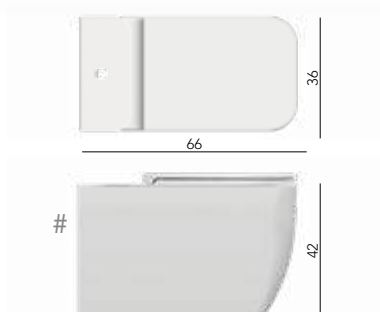

PALLET QUANTITY - 100x120x200h: 9+CW+CASS
PALLET QUANTITY - 80x120x200h: 6+CW+CASS

BIOKER + 115,00

Art. 5141

TEOREMA 2.0 CISTERN - 35 x 15 - 14 Kg



Cassetta per Art. 5140/CL
Wall cistern for Art. 5140/CL
Réservoir de chasse pour Art. 5140/CL
Spülkasten Für Art. 5140/CL
Cisterna Para Art. 5140/CL
бачок для Art. 5140/CL

WHITE 170,00

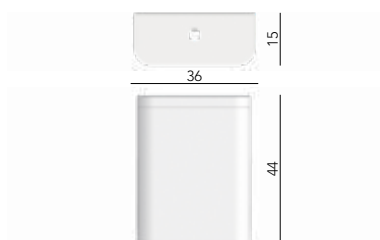

Art. 10022

115,00



Sistema di scarico per Art. 5141
 Flushing system for Art. 5141
 Système de chasse pour Art. 5141
 Ablaufsystem Für Art. 5141
 Sistema De Descarga Para Art. 5141
 Система слива для арт. 5141



Entrata acqua sotto a destra da 1/2"
 Right hand bottom 1/2" inch inlet
 Entrée eau en bas à droite 1/2 pouce
 Wassereinlauf unten rechts mit 1/2 zoll
 Entrada de agua inferior derecha de 1/2"
 Вход воды снизу справа, 1/2"

Art. 8305/A

TEOREMA 2.0 SEAT COVER

Sedile per Wc in termoindurente
 Seat cover Wc in termosetting resin
 Abattant wc en matière thermodurcissable
 WC-deckel Duroplas
 Asiento para inodoro en material termoenduracido
 Сиденье унитаза из термореактивного полимера

WHITE

140,00

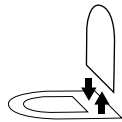

Con cerniere cromate - Sgancio rapido
 With chromed Kit - Rapid lift system
 Charnières chromées - Décrochage rapide
 Mit scharniere chrom - Schnellbefestigung
 Bisagras cromadas - Desenganche rápido
 С хромированными шарнирами - Быстрое отсоединение

Art. 8305/B

TEOREMA 2.0 SEAT COVER

Sedile per Wc in termoindurente
 Seat cover Wc in termosetting resin
 Abattant wc en matière thermodurcissable
 WC-deckel Duroplas
 Asiento para inodoro en material termoenduracido
 Сиденье унитаза из термореактивного полимера

WHITE

185,00

COLORS

260,00

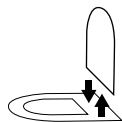
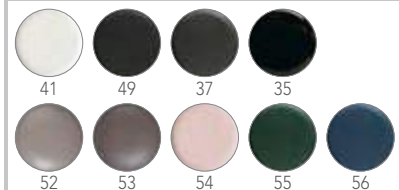

Con cerniera rallentata - Sgancio rapido
 With soft close system - Rapid lift system
 Charnieres avec frein de chute - Décrochage rapide
 Mit sanft abgebremsten scharnieren - Schnellbefestigung
 Con caída amortiguada - Desenganche rápido
 С микролифтом - Быстрое отсоединение

Art. 10005

FIXING SET

Staffe di montaggio Wc e bidet
 Fixing attachments for Wc and bidet
 Supports de montage pour cuvette et bidets suspendus
 Montagebügel Für Hänge-wc und bidet
 Soportes de montaje inodoro y bidé
 Монтажные кронштейны для унитаза и биде

--

70,00



Art. 5101

TEOREMA 2.0 60 - 60 x 40 Cm - 14 Kg - 12 L.



Lavabo da appoggio
Lay-on washbasin
Lavabo à poser
Aufsatzwaschbecken
Lavabo de apoyo
Раковина умывальника накладная

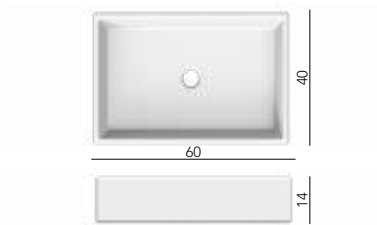

Senza troppo pieno - Consigliata piletta Art. 10034
Without overflow - Waste Art. 10034 recommended
Sans trop-plein - Bonde Art. 10034 conseillée
Ohne überlauf - Abfluss Art. 10034 empfohlen
Sin rebosadero - Recomendado desagüe Art. 10034
Без пробки перелива - Рекомендуется донный клапан арт. 10034

PALLET QUANTITY - 100x120x200h: 40
PALLET QUANTITY - 80x120x200h: 28

BIOKER + 115,00

WHITE 420,00

COLORS 600,00

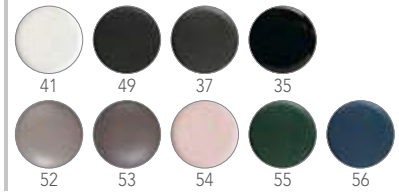

DecorLAB - DecorART 650,00

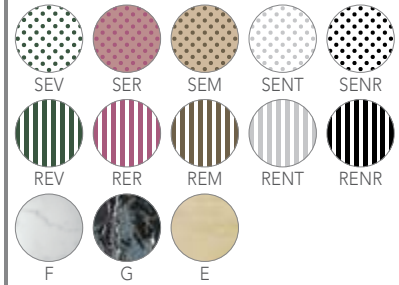

Art. 5102

TEOREMA 2.0 80 - 80 x 40 Cm - 17 Kg - 14 L.



Lavabo da appoggio
Lay-on washbasin
Lavabo à poser
Aufsatzwaschbecken
Lavabo de apoyo
Раковина умывальника накладная

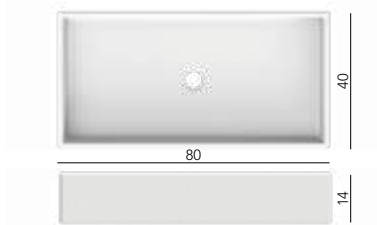

Senza troppo pieno - Consigliata piletta Art. 10034
Without overflow - Waste Art. 10034 recommended
Sans trop-plein - Bonde Art. 10034 conseillée
Ohne überlauf - Abfluss Art. 10034 empfohlen
Sin rebosadero - Recomendado desagüe Art. 10034
Без пробки перелива - Рекомендуется донный клапан арт. 10034

PALLET QUANTITY - 100x120x200h: 32
PALLET QUANTITY - 80x120x200h: 28

BIOKER + 115,00

WHITE 470,00

COLORS 650,00

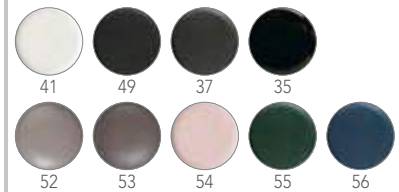

DecorLAB - DecorART 700,00

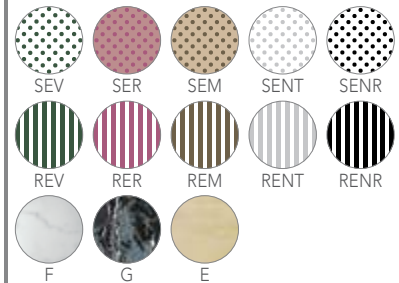

Art. 5129

TEOREMA 2.0 41R - 41 x 19 Cm - 7 Kg - 1,5 L.



Lavabo da appoggio
Lay-on washbasin
Lavabo à poser
Aufsatzwaschbecken
Lavabo de apoyo
Раковина умывальника накладная

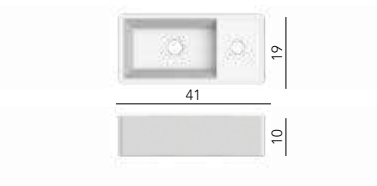

Senza troppo pieno - Consigliata piletta Art. 10034
Without overflow - Waste Art. 10034 recommended
Sans trop-plein - Bonde Art. 10034 conseillée
Ohne überlauf - Abfluss Art. 10034 empfohlen
Sin rebosadero - Recomendado desagüe Art. 10034
Без пробки перелива - Рекомендуется донный клапан арт. 10034

PALLET QUANTITY - 100x120x200h: 161
PALLET QUANTITY - 80x120x200h: 110

BIOKER + 115,00

WHITE 280,00

DecorLAB - DecorART 480,00

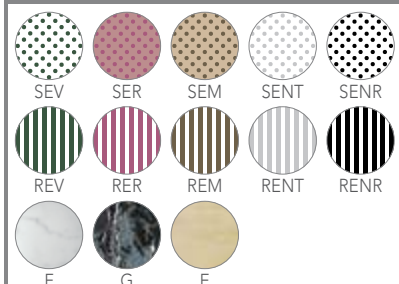

Art. 5155

TEOREMA 2.0 30R - 30 x 30 Cm - 6 Kg - 6 L.



Lavabo da appoggio o sospeso

Lay-on or wall-mounted washbasin

Lavabo à poser ou suspendu

Aufsatz-oder Hängewaschbecken

Lavabo de apoyo o suspendido

Раковина умывальника накладная или подвесная

WHITE

230,00

#

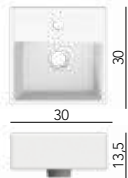

Fissaggi a muro compresi - Senza troppo pieno - Consigliata piletta Art. 10034

Wall attachments included - Without overflow - Waste Art. 10034 recommended

Fixations murales incluses - Sans trop-plein - Bonde Art. 10034 conseillée

Wandbefestigungen inklusive - Ohne überlauf - Abfluss Art. 10034 empfohlen

Fijación pared incluida - Sin rebosadero - Recomendado desagüe Art. 10034

Настенные крепления входят в комплект - Без пробки перелива - Рекомендуется донный клапан арт. 10034

PALLET QUANTITY - 100x120x200h: 102

PALLET QUANTITY - 80x120x200h: 86

BIOKER + 115,00

Art. 5111

TEOREMA 2.0 50 - 50,5 x 38,5 Cm - 13,6 Kg - 4 L.



Lavabo da appoggio o sospeso

Lay-on or wall-mounted washbasin

Lavabo à poser ou suspendu

Aufsatz-oder Hängewaschbecken

Lavabo de apoyo o suspendido

Раковина умывальника накладная или подвесная

WHITE

370,00

COLORS

570,00



#

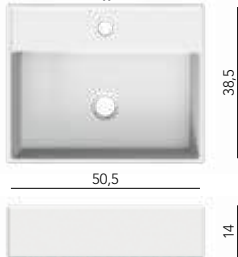

Fissaggi a muro compresi - Borchia troppo pieno compresa

Wall attachments included - Overflow cap included

Fixations murales incluses - Anneau trop-plein inclus

Wandbefestigungen inklusive - Beschlag für Überlaufschutz inklusive

Fijación pared incluida - Tachón rebosadero incluido

Настенные крепления входят в комплект - Перелив входит в комплект

PALLET QUANTITY - 100x120x200h: 50

PALLET QUANTITY - 80x120x200h: 36

BIOKER + 115,00

DecorLAB - DecorART 600,00

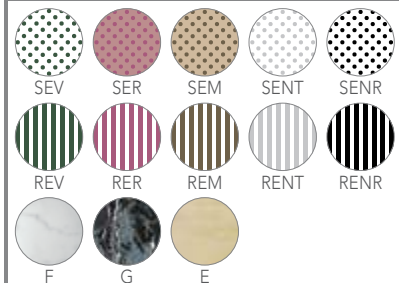

Art. 5112

TEOREMA 2.0 50AP - 50,5 x 38,5 Cm - 13,6 Kg - 4 L.



Lavabo da appoggio

Lay-on washbasin

Lavabo à poser

Aufsatzwaschbecken

Lavabo de apoyo

Раковина умывальника накладная

WHITE

370,00

COLORS

570,00

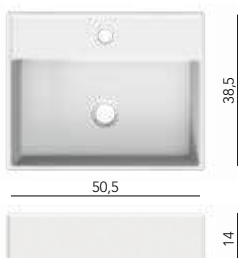

Smaltato su 4 lati - Borchia troppo pieno compresa

Enamelled on 4 sides - Overflow cap included

Emaillé sur 4 côtés - Anneau trop-plein inclus

Vier Seiten emailliert - Beschlag für Überlaufschutz inklusive

Esmaltado por los cuatro lados - Tachón rebosadero incluido

Эмалированный с 4 сторон - Перелив входит в комплект

PALLET QUANTITY - 100x120x200h: 50

PALLET QUANTITY - 80x120x200h: 36

BIOKER + 115,00

DecorLAB - DecorART 600,00

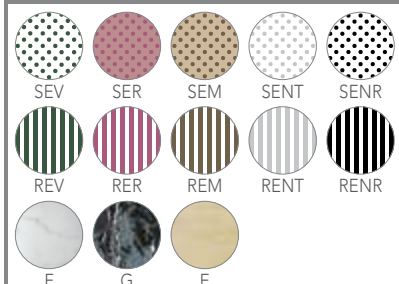

Art. 5156

TEOREMA 60 x 38,5R - 60 x 38,5 Cm - 12 Kg - 3 L.



Lavabo da appoggio o sospeso
Lay-on or wall-mounted washbasin
Lavabo à poser ou suspendu
Aufsatz-oder Hängewaschbecken
Lavabo de apoyo o suspendido
Раковина умывальника накладная или подвесная

WHITE 500,00

COLORS 700,00

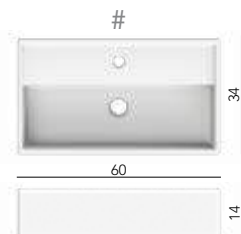
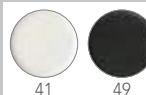

Fissaggi a muro compresi - Borchia troppo pieno compresa
Wall attachments included - Overflow cap included
Fixations murales incluses - Anneau trop-plein inclus
Wandbefestigungen inklusive - Beschlag für Überlaufschutz inklusive
Fijación pared incluida - Tachón rebosadero incluido
Настенные крепления входят в комплект - Перелив входит в комплект

PALLET QUANTITY - 100x120x200h: 31

PALLET QUANTITY - 80x120x200h: 24

BIOKER + 115,00

Art. 5104

TEOREMA 2.0 46R - 46 x 46 Cm - 13 Kg - 3,5 L.



Lavabo da appoggio o sospeso
Lay-on or wall-mounted washbasin
Lavabo à poser ou suspendu
Aufsatz-oder Hängewaschbecken
Lavabo de apoyo o suspendido
Раковина умывальника накладная или подвесная

WHITE 370,00

COLORS 570,00

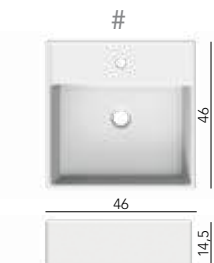

Fissaggi a muro compresi - Borchia troppo pieno compresa
Wall attachments included - Overflow cap included
Fixations murales incluses - Anneau trop-plein inclus
Wandbefestigungen inklusive - Beschlag für Überlaufschutz inklusive
Fijación pared incluida - Tachón rebosadero incluido
Настенные крепления входят в комплект - Перелив входит в комплект

PALLET QUANTITY - 100x120x200h: 50

PALLET QUANTITY - 80x120x200h: 28

BIOKER + 115,00

DecorLAB - DecorART 600,00

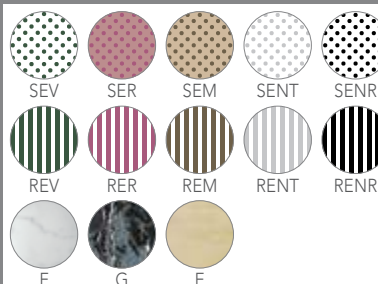

Art. 5105

TEOREMA 2.0 60R - 60 x 46 Cm - 17 Kg - 4 L.



Lavabo da appoggio o sospeso
Lay-on or wall-mounted washbasin
Lavabo à poser ou suspendu
Aufsatz-oder Hängewaschbecken
Lavabo de apoyo o suspendido
Раковина умывальника накладная или подвесная

WHITE 470,00

COLORS 670,00

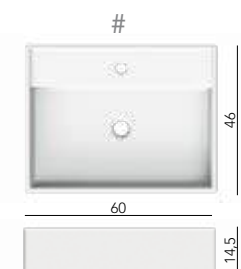
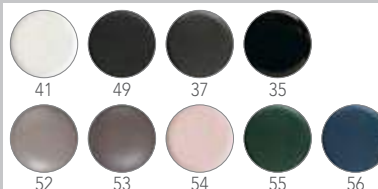

Fissaggi a muro compresi - Borchia troppo pieno compresa
Wall attachments included - Overflow cap included
Fixations murales incluses - Anneau trop-plein inclus
Wandbefestigungen inklusive - Beschlag für Überlaufschutz inklusive
Fijación pared incluida - Tachón rebosadero incluido
Настенные крепления входят в комплект - Перелив входит в комплект

PALLET QUANTITY - 100x120x200h: 34

PALLET QUANTITY - 80x120x200h: 26

BIOKER + 115,00

DecorLAB - DecorART 700,00

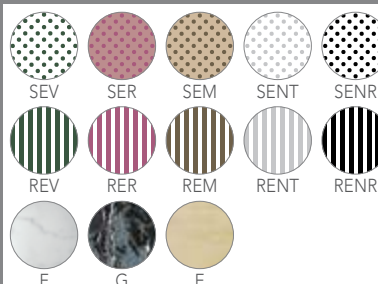

Art. 5114

TEOREMA 2.0 60 SHELF DX® - 60 x 44 Cm - 16,6 Kg - 2,5 L.

- MODELLO REGISTRATO -
- REGISTERED MODEL -



Lavabo da appoggio o sospeso

Lay-on or wall-mounted washbasin

Lavabo à poser ou suspendu

Aufsatz-oder Hängewaschbecken

Lavabo de apoyo o suspendido

Раковина умывальника накладная или подвесная

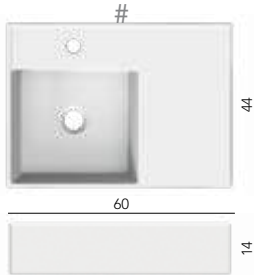

Fissaggi a muro compresi - Borchia troppo pieno compresa

Wall attachments included - Overflow cap included

Fixations murales incluses - Anneau trop-plein inclus

Wandbefestigungen inklusive - Beschlag für Überlaufschutz inklusive

Fijación pared incluida - Tachón rebosadero incluido

Настенные крепления входят в комплект - Перелив входит в комплект

PALLET QUANTITY - 100x120x200h: 40

PALLET QUANTITY - 80x120x200h: 28

BIOKER + 115,00

WHITE

470,00

COLORS

670,00

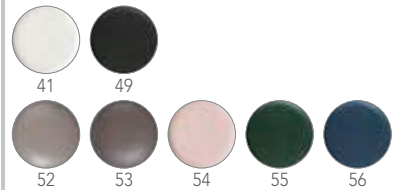

DecorLAB - DecorART 700,00

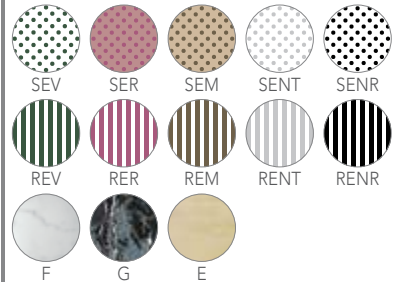

Art. 5117

TEOREMA 2.0 60 SHELF SX® - 60 x 44 Cm - 16,6 Kg - 2,5 L.

- MODELLO REGISTRATO -
- REGISTERED MODEL -



Lavabo da appoggio o sospeso

Lay-on or wall-mounted washbasin

Lavabo à poser ou suspendu

Aufsatz-oder Hängewaschbecken

Lavabo de apoyo o suspendido

Раковина умывальника накладная или подвесная

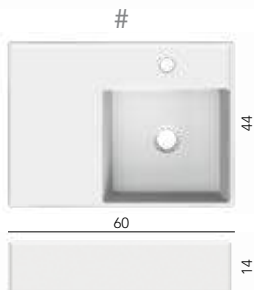

Fissaggi a muro compresi - Borchia troppo pieno compresa

Wall attachments included - Overflow cap included

Fixations murales incluses - Anneau trop-plein inclus

Wandbefestigungen inklusive - Beschlag für Überlaufschutz inklusive

Fijación pared incluida - Tachón rebosadero incluido

Настенные крепления входят в комплект - Перелив входит в комплект

PALLET QUANTITY - 100x120x200h: 40

PALLET QUANTITY - 80x120x200h: 28

BIOKER + 115,00

WHITE

470,00

COLORS

670,00

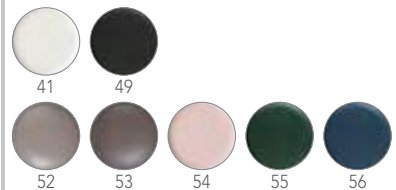

DecorLAB - DecorART 700,00

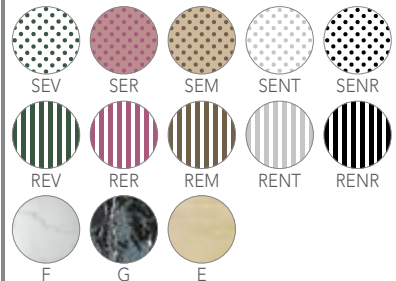

Art. 5110

TEOREMA 2.0 80R - 80 x 46 Cm - 20 Kg - 5,5 L.



Lavabo da appoggio o sospeso

Lay-on or wall-mounted washbasin

Lavabo à poser ou suspendu

Aufsatz-oder Hängewaschbecken

Lavabo de apoyo o suspendido

Раковина умывальника накладная или подвесная

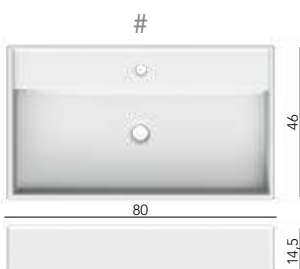

Fissaggi a muro compresi - Borchia troppo pieno compresa

Wall attachments included - Overflow cap included

Fixations murales incluses - Anneau trop-plein inclus

Wandbefestigungen inklusive - Beschlag für Überlaufschutz inklusive

Fijación pared incluida - Tachón rebosadero incluido

Настенные крепления входят в комплект - Перелив входит в комплект

PALLET QUANTITY - 100x120x200h: 28

PALLET QUANTITY - 80x120x200h: 25

BIOKER + 115,00

WHITE

500,00

COLORS

700,00

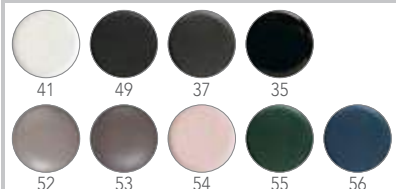

DecorLAB - DecorART 740,00

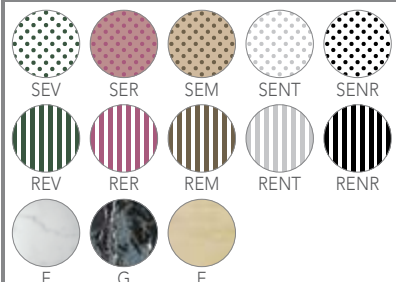

Art. 5115

TEOREMA 2.0 80 SHELF DX® - 80 x 44 Cm - 20 Kg - 4 L.

- MODELLO REGISTRATO -
- REGISTERED MODEL -



Lavabo da appoggio o sospeso

Lay-on or wall-mounted washbasin

Lavabo à poser ou suspendu

Aufsatz-oder Hängewaschbecken

Lavabo de apoyo o suspendido

Раковина умывальника накладная или подвесная

WHITE 515,00

COLORS 715,00

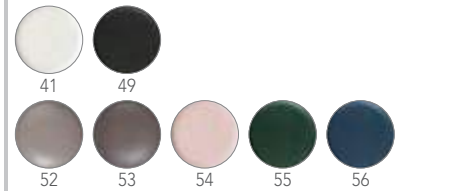

DecorLAB - DecorART 750,00

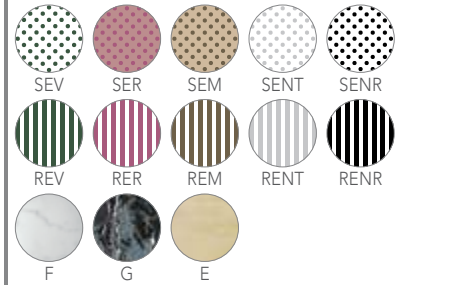

#

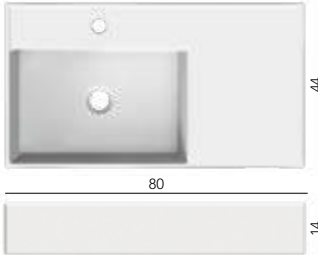

Fissaggi a muro compresi - Borchia troppo pieno compresa

Wall attachments included - Overflow cap included

Fixations murales incluses - Anneau trop-plein inclus

Wandbefestigungen inklusive - Beschlag für Überlaufschutz inklusive

Fijación pared incluida - Tachón rebosadero incluido

Настенные крепления входят в комплект - Перелив входит в комплект

PALLET QUANTITY - 100x120x200h: 28

PALLET QUANTITY - 80x120x200h: 25

BIOKER + 115,00

Art. 5118

TEOREMA 2.0 80 SHELF SX® - 80 x 44 Cm - 20 Kg - 4 L.

- MODELLO REGISTRATO -
- REGISTERED MODEL -



Lavabo da appoggio o sospeso

Lay-on or wall-mounted washbasin

Lavabo à poser ou suspendu

Aufsatz-oder Hängewaschbecken

Lavabo de apoyo o suspendido

Раковина умывальника накладная или подвесная

WHITE 515,00

COLORS 715,00

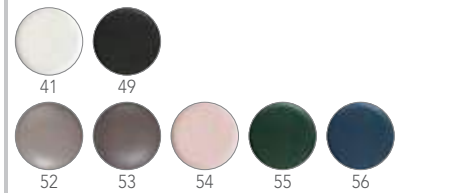

DecorLAB - DecorART 750,00

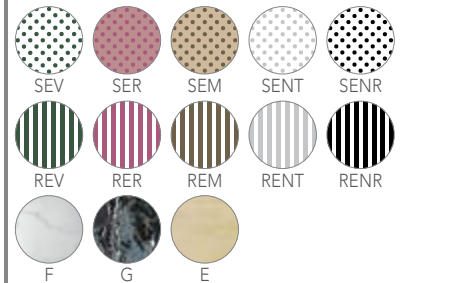

#

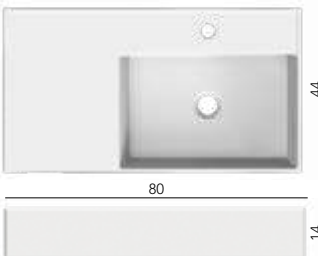

Fissaggi a muro compresi - Borchia troppo pieno compresa

Wall attachments included - Overflow cap included

Fixations murales incluses - Anneau trop-plein inclus

Wandbefestigungen inklusive - Beschlag für Überlaufschutz inklusive

Fijación pared incluida - Tachón rebosadero incluido

Настенные крепления входят в комплект - Перелив входит в комплект

PALLET QUANTITY - 100x120x200h: 28

PALLET QUANTITY - 80x120x200h: 25

BIOKER + 115,00

Art. 5123

TEOREMA 2.0 80 DOUBLE SHELF® - 81 x 44 Cm - 22 Kg - 3 L.

- MODELLO REGISTRATO -
- REGISTERED MODEL -



Lavabo da appoggio o sospeso

Lay-on or wall-mounted washbasin

Lavabo à poser ou suspendu

Aufsatz-oder Hängewaschbecken

Lavabo de apoyo o suspendido

Раковина умывальника накладная или подвесная

WHITE 515,00

COLORS 715,00

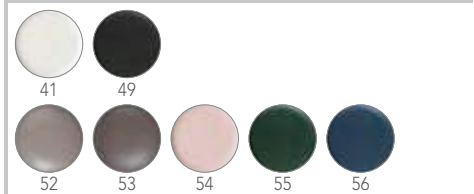

DecorLAB - DecorART 750,00

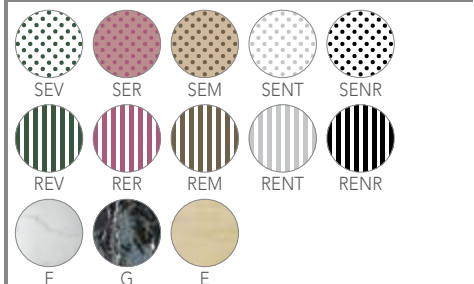

#

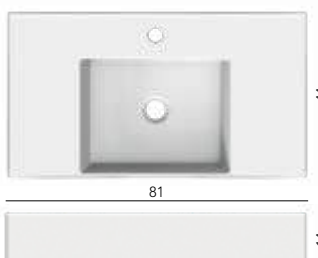

Fissaggi a muro compresi - Borchia troppo pieno compresa

Wall attachments included - Overflow cap included

Fixations murales incluses - Anneau trop-plein inclus

Wandbefestigungen inklusive - Beschlag für Überlaufschutz inklusive

Fijación pared incluida - Tachón rebosadero incluido

Настенные крепления входят в комплект - Перелив входит в комплект

PALLET QUANTITY - 100x120x200h: 28

PALLET QUANTITY - 80x120x200h: 25

BIOKER + 115,00

Art. 5106/R-100A

TEOREMA 2.0 100R A - 100 x 46 Cm - 24 Kg - 7 L.



Lavabo da appoggio o sospeso
Lay-on or wall-mounted washbasin
Lavabo à poser ou suspendu
Aufsatz-oder Hängewaschbecken
Lavabo de apoyo o suspendido
Раковина умывальника накладная или подвесная

WHITE 630,00

COLORS 830,00

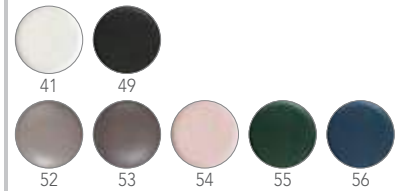

DecorART 850,00

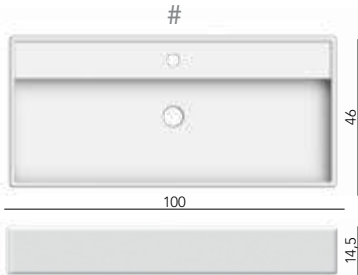
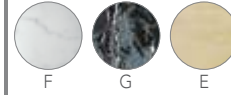

Fissaggi a muro compresi - Borchia troppo pieno compresa
Wall attachments included - Overflow cap included
Fixations murales incluses - Anneau trop-plein inclus
Wandbefestigungen inklusive - Beschlag für Überlaufschutz inklusive
Fijación pared incluida - Tachón rebosadero incluido
Настенные крепления входят в комплект - Перелив входит в комплект

PALLET QUANTITY - 100x120x200h: 20

PALLET QUANTITY - 80x120x200h: 16

BIOKER + 115,00

Art. 5106/R-100B

TEOREMA 2.0 100R B - 100 x 46 Cm - 24 Kg - 7 L.



Lavabo da appoggio o sospeso
Lay-on or wall-mounted washbasin
Lavabo à poser ou suspendu
Aufsatz-oder Hängewaschbecken
Lavabo de apoyo o suspendido
Раковина умывальника накладная или подвесная

WHITE 630,00

COLORS 830,00

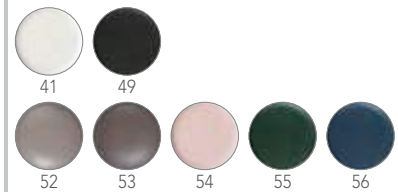

DecorART 850,00

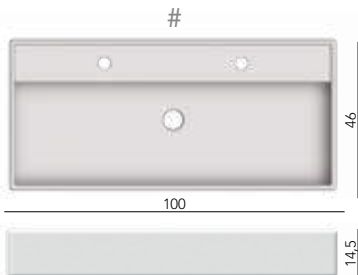
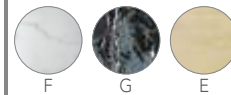

Fissaggi a muro compresi - Borchia troppo pieno compresa
Wall attachments included - Overflow cap included
Fixations murales incluses - Anneau trop-plein inclus
Wandbefestigungen inklusive - Beschlag für Überlaufschutz inklusive
Fijación pared incluida - Tachón rebosadero incluido
Настенные крепления входят в комплект - Перелив входит в комплект

PALLET QUANTITY - 100x120x200h: 20

PALLET QUANTITY - 80x120x200h: 16

BIOKER + 115,00

Art. 5119

TEOREMA 2.0 100 SHELF DX® - 101 x 46 Cm - 25 Kg - 4 L.

- MODELLO REGISTRATO -
- REGISTERED MODEL -



Lavabo da appoggio o sospeso
Lay-on or wall-mounted washbasin
Lavabo à poser ou suspendu
Aufsatz-oder Hängewaschbecken
Lavabo de apoyo o suspendido
Раковина умывальника накладная или подвесная

WHITE 630,00

COLORS 830,00

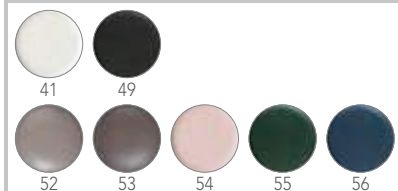

DecorART 850,00

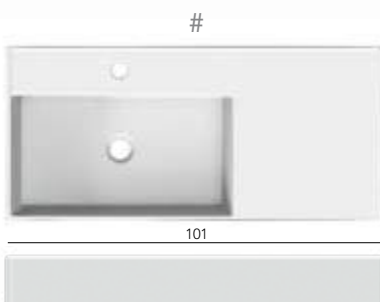
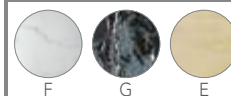

Fissaggi a muro compresi - Borchia troppo pieno compresa
Wall attachments included - Overflow cap included
Fixations murales incluses - Anneau trop-plein inclus
Wandbefestigungen inklusive - Beschlag für Überlaufschutz inklusive
Fijación pared incluida - Tachón rebosadero incluido
Настенные крепления входят в комплект - Перелив входит в комплект

PALLET QUANTITY - 100x120x200h: 20

PALLET QUANTITY - 80x120x200h: 16

BIOKER + 115,00

Art. 5120

- MODELLO REGISTRATO -
- REGISTERED MODEL -

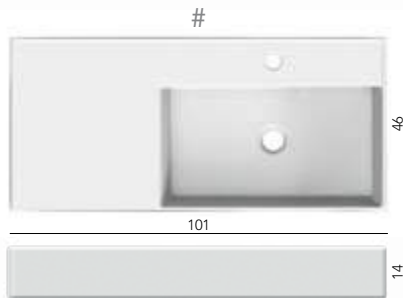

TEOREMA 2.0 100 SHELF SX® - 101 x 46 Cm - 25 Kg - 4 L.

Lavabo da appoggio o sospeso

Lay-on or wall-mounted washbasin

Lavabo à poser ou suspendu

Aufsatz-oder Hängewaschbecken

Lavabo de apoyo o suspendido

Раковина умывальника накладная или подвесная

Fissaggi a muro compresi - Borchia troppo pieno compresa

Wall attachments included - Overflow cap included

Fixations murales incluses - Anneau trop-plein inclus

Wandbefestigungen inklusive - Beschlag für Überlaufschutz inklusive

Fijación pared incluida - Tachón rebosadero incluido

Настенные крепления входят в комплект - Перелив входит в комплект

PALLET QUANTITY - 100x120x200h: 20

PALLET QUANTITY - 80x120x200h: 16

BIOKER + 115,00

WHITE 630,00

COLORS 830,00

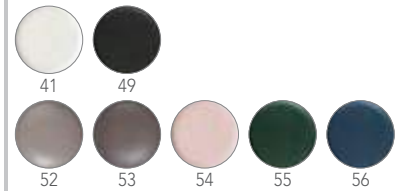

DecorART 850,00

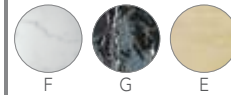

Art. 5124

- MODELLO REGISTRATO -
- REGISTERED MODEL -

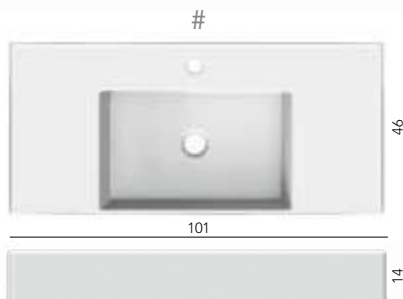

TEOREMA 2.0 100 DOUBLE SHELF® - 101 x 46 Cm - 25 Kg - 3,7 L.

Lavabo da appoggio o sospeso

Lay-on or wall-mounted washbasin

Lavabo à poser ou suspendu

Aufsatz-oder Hängewaschbecken

Lavabo de apoyo o suspendido

Раковина умывальника накладная или подвесная

Fissaggi a muro compresi - Borchia troppo pieno compresa

Wall attachments included - Overflow cap included

Fixations murales incluses - Anneau trop-plein inclus

Wandbefestigungen inklusive - Beschlag für Überlaufschutz inklusive

Fijación pared incluida - Tachón rebosadero incluido

Настенные крепления входят в комплект - Перелив входит в комплект

PALLET QUANTITY - 100x120x200h: 20

PALLET QUANTITY - 80x120x200h: 16

BIOKER + 115,00

WHITE 630,00

COLORS 830,00

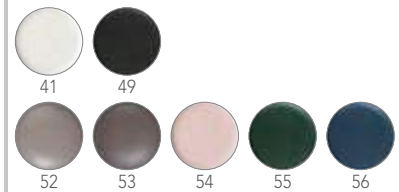

DecorART 850,00

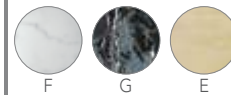

Art. 5142

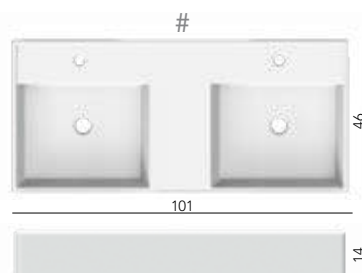

TEOREMA 2.0 101x46 - 101 x 46 Cm - 30 Kg - 5 L.

Lavabo da appoggio o sospeso

Lay-on or wall-mounted washbasin

Lavabo à poser ou suspendu

Aufsatz-oder Hängewaschbecken

Lavabo de apoyo o suspendido

Раковина умывальника накладная или подвесная

Fissaggi a muro compresi - Borchia troppo pieno compresa

Wall attachments included - Overflow cap included

Fixations murales incluses - Anneau trop-plein inclus

Wandbefestigungen inklusive - Beschlag für Überlaufschutz inklusive

Fijación pared incluida - Tachón rebosadero incluido

Настенные крепления входят в комплект - Перелив входит в комплект

PALLET QUANTITY - 100x120x200h: 20

PALLET QUANTITY - 80x120x200h: 16

BIOKER + 115,00

WHITE 630,00

COLORS 830,00

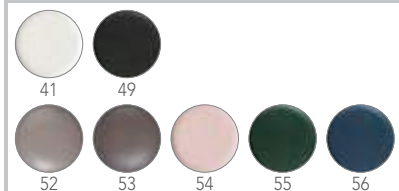

Art. 5107/R-120A

TEOREMA 2.0 120R A - 120 x 46 Cm - 28 Kg - 8 L.

Lavabo da appoggio o sospeso
Lay-on or wall-mounted washbasin
Lavabo à poser ou suspendu
Aufsatz-oder Hängewaschbecken
Lavabo de apoyo o suspendido
Раковина умывальника накладная или подвесная

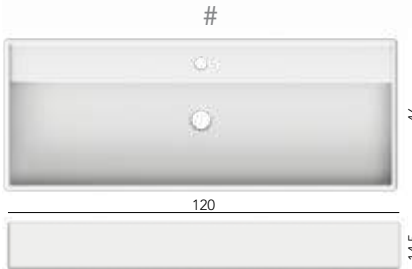

Fissaggi a muro compresi - Borchia troppo pieno compresa
Wall attachments included - Overflow cap included
Fixations murales incluses - Anneau trop-plein inclus
Wandbefestigungen inklusive - Beschlag für Überlaufschutz inklusive
Fijación pared incluida - Tachón rebosadero incluido
Настенные крепления входят в комплект - Перелив входит в комплект

PALLET QUANTITY - 100x120x200h: 17
PALLET QUANTITY - 80x120x200h: 13

BIOKER + 115,00

WHITE 750,00

COLORS 950,00



DecorART 980,00

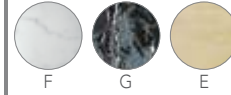

Art. 5107/R-120B

TEOREMA 2.0 120R B - 120 x 46 Cm - 28 Kg - 8 L.

Lavabo da appoggio o sospeso
Lay-on or wall-mounted washbasin
Lavabo à poser ou suspendu
Aufsatz-oder Hängewaschbecken
Lavabo de apoyo o suspendido
Раковина умывальника накладная или подвесная

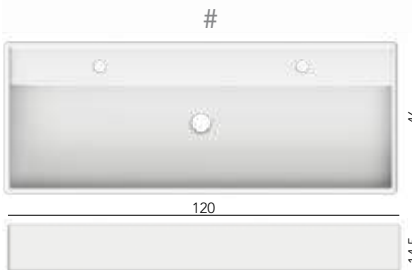

Fissaggi a muro compresi - Borchia troppo pieno compresa
Wall attachments included - Overflow cap included
Fixations murales incluses - Anneau trop-plein inclus
Wandbefestigungen inklusive - Beschlag für Überlaufschutz inklusive
Fijación pared incluida - Tachón rebosadero incluido
Настенные крепления входят в комплект - Перелив входит в комплект

PALLET QUANTITY - 100x120x200h: 17
PALLET QUANTITY - 80x120x200h: 13

BIOKER + 115,00

WHITE 750,00

COLORS 950,00



DecorART 980,00

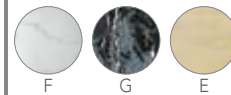

Art. 5121

TEOREMA 2.0 120 SHELF DX® - 121 x 46 Cm - 29 Kg - 5,5 L.

- MODELLO REGISTRATO -
- REGISTERED MODEL -

Lavabo da appoggio o sospeso
Lay-on or wall-mounted washbasin
Lavabo à poser ou suspendu
Aufsatz-oder Hängewaschbecken
Lavabo de apoyo o suspendido
Раковина умывальника накладная или подвесная

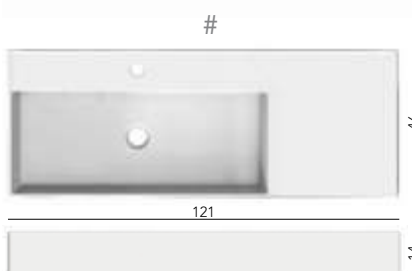

Fissaggi a muro compresi - Borchia troppo pieno compresa
Wall attachments included - Overflow cap included
Fixations murales incluses - Anneau trop-plein inclus
Wandbefestigungen inklusive - Beschlag für Überlaufschutz inklusive
Fijación pared incluida - Tachón rebosadero incluido
Настенные крепления входят в комплект - Перелив входит в комплект

PALLET QUANTITY - 100x120x200h: 17
PALLET QUANTITY - 80x120x200h: 13

BIOKER + 115,00

WHITE 750,00

COLORS 950,00

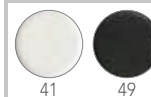

DecorART 980,00



Art. 5122

TEOREMA 2.0 120 SHELF SX® - 121 x 46 Cm - 29 Kg - 5,5 L.

- MODELLO REGISTRATO -
- REGISTERED MODEL -



Lavabo da appoggio o sospeso

Lay-on or wall-mounted washbasin

Lavabo à poser ou suspendu

Aufsatz-oder Hängewaschbecken

Lavabo de apoyo o suspendido

Раковина умывальника накладная или подвесная

WHITE 750,00

COLORS 950,00

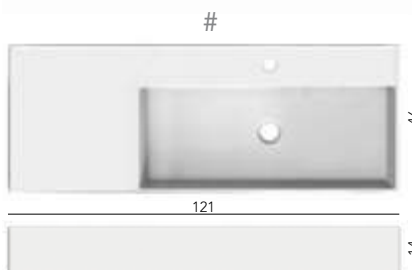

Fissaggi a muro compresi - Borchia troppo pieno compresa

Wall attachments included - Overflow cap included

Fixations murales incluses - Anneau trop-plein inclus

Wandbefestigungen inklusive - Beschlag für Überlaufschutz inklusive

Fijación pared incluida - Tachón rebosadero incluido

Настенные крепления входят в комплект - Перелив входит в комплект

PALLET QUANTITY - 100x120x200h: 17

PALLET QUANTITY - 80x120x200h: 13

BIOKER + 115,00

DecorART 980,00

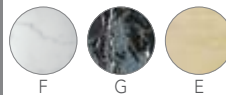

Art. 5125

TEOREMA 2.0 120 DOUBLE SHELF® - 121 x 46 Cm - 29 Kg - 4 L.

- MODELLO REGISTRATO -
- REGISTERED MODEL -



Lavabo da appoggio o sospeso

Lay-on or wall-mounted washbasin

Lavabo à poser ou suspendu

Aufsatz-oder Hängewaschbecken

Lavabo de apoyo o suspendido

Раковина умывальника накладная или подвесная

WHITE 750,00

COLORS 950,00

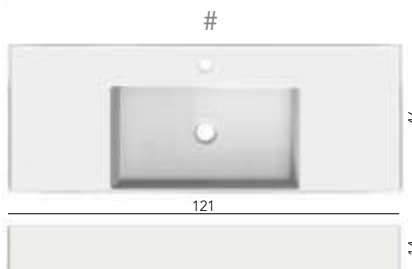

Fissaggi a muro compresi - Borchia troppo pieno compresa

Wall attachments included - Overflow cap included

Fixations murales incluses - Anneau trop-plein inclus

Wandbefestigungen inklusive - Beschlag für Überlaufschutz inklusive

Fijación pared incluida - Tachón rebosadero incluido

Настенные крепления входят в комплект - Перелив входит в комплект

PALLET QUANTITY - 100x120x200h: 17

PALLET QUANTITY - 80x120x200h: 13

BIOKER + 115,00

DecorART 980,00

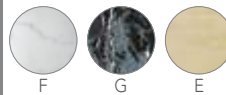

Art. 5143

TEOREMA 2.0 121x46 - 121,5 x 46 Cm - 33 Kg - 7 L.

Lavabo da appoggio o sospeso

Lay-on or wall-mounted washbasin

Lavabo à poser ou suspendu

Aufsatz-oder Hängewaschbecken

Lavabo de apoyo o suspendido

Раковина умывальника накладная или подвесная

WHITE 750,00

COLORS 950,00



Fissaggi a muro compresi - Borchia troppo pieno compresa

Wall attachments included - Overflow cap included

Fixations murales incluses - Anneau trop-plein inclus

Wandbefestigungen inklusive - Beschlag für Überlaufschutz inklusive

Fijación pared incluida - Tachón rebosadero incluido

Настенные крепления входят в комплект - Перелив входит в комплект

PALLET QUANTITY - 100x120x200h: 17

PALLET QUANTITY - 80x120x200h: 13

BIOKER + 115,00

Art. 5116

TEOREMA 2.0 141 x 46 - 141,5 x 45,5 Cm - 36,5 Kg - 8 L.

- MODELLO REGISTRATO -
- REGISTERED MODEL -

Lavabo da appoggio o sospeso

Lay-on or wall-mounted washbasin

Lavabo à poser ou suspendu

Aufsatz- oder Hängewaschbecken

Lavabo de apoyo o suspendido

Раковина умывальника накладная или подвесная



WHITE

995,00

COLORS

1.250,00



Fissaggi a muro compresi - Borchia troppo pieno compresa

Wall attachments included - Overflow cap included

Fixations murales incluses - Anneau trop-plein inclus

Wandbefestigungen inklusive - Beschlag für Überlaufschutz inklusive

Fijación pared incluida - Tachón rebosadero incluido

Настенные крепления входят в комплект - Перелив входит в комплект

PALLET QUANTITY - 100x120x200h: 18

PALLET QUANTITY - 80x120x200h: 13

BIOKER + 115,00

Art. 5108

TEOREMA 2.0 45A BUILT-IN - 45 x 44 Cm - 14 Kg - 3,5 L.

Lavabo da incasso

Built-in washbasin

Lavabo encastré

Einbauwaschbecken

Lavabo de encaje

Раковина умывальника встраиваемая



WHITE

355,00

COLORS

560,00

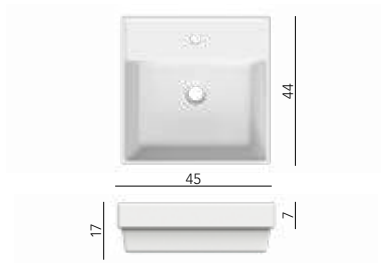

Borchia troppo pieno compresa

Overflow cap included

Anneau trop-plein inclus

Beschlag für Überlaufschutz inklusive

Tachón rebosadero incluido

Перелив входит в комплект

PALLET QUANTITY - 100x120x200h: 50

PALLET QUANTITY - 80x120x200h: 28

BIOKER + 115,00

DecorLAB - DecorART

590,00

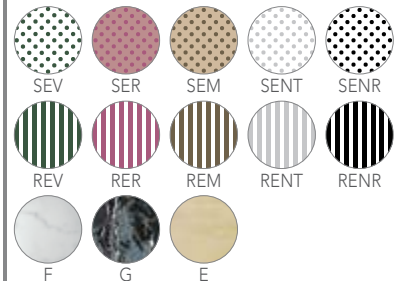

Art. 5109

TEOREMA 2.0 60A BUILT-IN - 60 x 44 Cm - 18 Kg - 4,5 L.

Lavabo da incasso

Built-in washbasin

Lavabo encastré

Einbauwaschbecken

Lavabo de encaje

Раковина умывальника встраиваемая



WHITE

460,00

COLORS

660,00

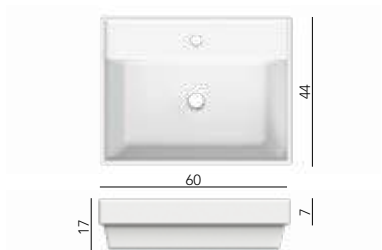

Borchia troppo pieno compresa

Overflow cap included

Anneau trop-plein inclus

Beschlag für Überlaufschutz inklusive

Tachón rebosadero incluido

Перелив входит в комплект

PALLET QUANTITY - 100x120x200h: 34

PALLET QUANTITY - 80x120x200h: 26

BIOKER + 115,00

DecorLAB - DecorART

700,00

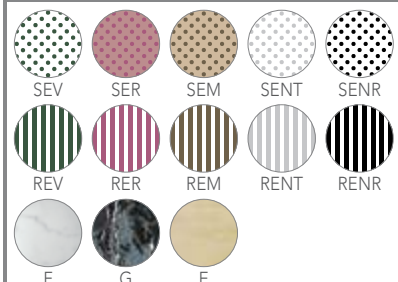

Art. 5130

TEOREMA 2.0 45x36 - 45 x 36 Cm - 12 Kg - 4 L.



Lavabo da incasso
Built-in washbasin
Lavabo encastré
Einbauwaschbecken
Lavabo de encaje
Раковина умывальника встраиваемая

WHITE 280,00

COLORS 490,00

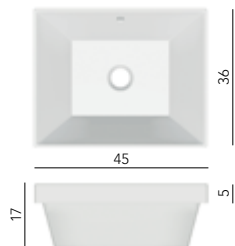

Borchia troppo pieno compresa
Overflow cap included
Anneau trop-plein inclus
Beschlag für Überlaufschutz inklusive
Tachón rebosadero incluido
Перелив входит в комплект

PALLET QUANTITY - 100x120x200h: 50

PALLET QUANTITY - 80x120x200h: 28

BIOKER + 115,00

Art. 5131

TEOREMA 2.0 60x36 - 60 x 36 Cm - 14 Kg - 6 L.



Lavabo da incasso
Built-in washbasin
Lavabo encastré
Einbauwaschbecken
Lavabo de encaje
Раковина умывальника встраиваемая

WHITE 310,00

COLORS 515,00



Borchia troppo pieno compresa
Overflow cap included
Anneau trop-plein inclus
Beschlag für Überlaufschutz inklusive
Tachón rebosadero incluido
Перелив входит в комплект

PALLET QUANTITY - 100x120x200h: 31

PALLET QUANTITY - 80x120x200h: 24

BIOKER + 115,00

Art. 5132

TEOREMA 2.0 80x36 - 80 x 36 Cm - 19 Kg - 6 L.



Lavabo da incasso
Built-in washbasin
Lavabo encastré
Einbauwaschbecken
Lavabo de encaje
Раковина умывальника встраиваемая

WHITE 390,00

COLORS 590,00

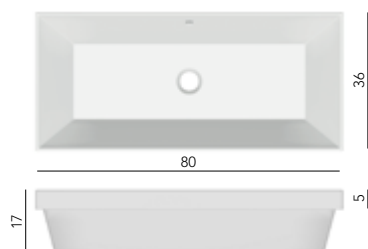

Borchia troppo pieno compresa
Overflow cap included
Anneau trop-plein inclus
Beschlag für Überlaufschutz inklusive
Tachón rebosadero incluido
Перелив входит в комплект

PALLET QUANTITY - 100x120x200h: 30

PALLET QUANTITY - 80x120x200h: 16

BIOKER + 115,00

Art. 5133

TEOREMA 2.0 100x36 - 100 x 36 Cm - 23 Kg - 8,5 L.



Lavabo da incasso
Built-in washbasin
Lavabo encastré
Einbauwaschbecken
Lavabo de encaje
Раковина умывальника встраиваемая

WHITE 450,00

COLORS 650,00



Borchia troppo pieno compresa
Overflow cap included
Anneau trop-plein inclus
Beschlag für Überlaufschutz inklusive
Tachón rebosadero incluido
Перелив входит в комплект

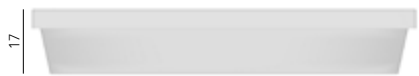

PALLET QUANTITY - 100x120x200h: 24
PALLET QUANTITY - 80x120x200h: 16

BIOKER + 115,00

Art. 5153

TEOREMA 2.0 120x36 - 120 x 36 Cm - 26 Kg - 13,5 L.



Lavabo da incasso
Built-in washbasin
Lavabo encastré
Einbauwaschbecken
Lavabo de encaje
Раковина умывальника встраиваемая

WHITE 530,00

COLORS 780,00

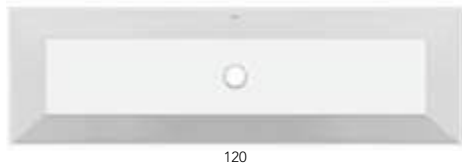

Borchia troppo pieno compresa
Overflow cap included
Anneau trop-plein inclus
Beschlag für Überlaufschutz inklusive
Tachón rebosadero incluido
Перелив входит в комплект

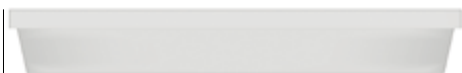

PALLET QUANTITY - 100x120x200h: 20
PALLET QUANTITY - 80x120x200h: 16

BIOKER + 115,00

Art. 5134

TEOREMA 2.0 45x36S - 45 x 36 Cm - 12 Kg - 4 L.



Lavabo sottopiano
Under-top washbasin
Lavabo encastré par dessous
Unterbauwaschbecken
Lavabo bajo encimera
Раковина умывальника под столешницу

WHITE 280,00

COLORS 490,00



Borchia troppo pieno compresa
Overflow cap included
Anneau trop-plein inclus
Beschlag für Überlaufschutz inklusive
Tachón rebosadero incluido
Перелив входит в комплект



PALLET QUANTITY - 100x120x200h: 50
PALLET QUANTITY - 80x120x200h: 28

BIOKER + 115,00

Art. 5135

TEOREMA 2.0 60x36S - 60 x 36 Cm - 14 Kg - 5 L.



Lavabo sottopiano
 Under-top washbasin
 Lavabo encastré par dessous
 Unterbauwaschbecken
 Lavabo bajo encimera
 Раковина умывальника под столешницу

WHITE 310,00

COLORS 515,00



49



Borchia troppo pieno compresa
 Overflow cap included
 Anneau trop-plein inclus
 Beschlag für Überlaufschutz inklusive
 Tachón rebosadero incluido
 Перелив входит в комплект

PALLET QUANTITY - 100x120x200h: 31

PALLET QUANTITY - 80x120x200h: 24

BIOKER + 115,00

Art. 5136

TEOREMA 2.0 80x36S - 80 x 36 Cm - 19 Kg - 6 L.



Lavabo sottopiano
 Under-top washbasin
 Lavabo encastré par dessous
 Unterbauwaschbecken
 Lavabo bajo encimera
 Раковина умывальника под столешницу

WHITE 390,00

COLORS 590,00



49

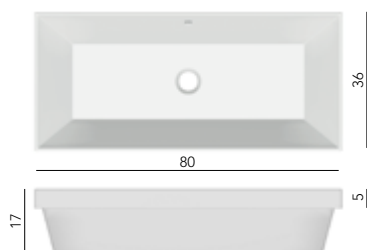

Borchia troppo pieno compresa
 Overflow cap included
 Anneau trop-plein inclus
 Beschlag für Überlaufschutz inklusive
 Tachón rebosadero incluido
 Перелив входит в комплект

PALLET QUANTITY - 100x120x200h: 30

PALLET QUANTITY - 80x120x200h: 16

BIOKER + 115,00

Art. 5137

TEOREMA 2.0 100x36S - 100 x 36 Cm - 23 Kg - 8,5 L.



Lavabo sottopiano
 Under-top washbasin
 Lavabo encastré par dessous
 Unterbauwaschbecken
 Lavabo bajo encimera
 Раковина умывальника под столешницу

WHITE 450,00

COLORS 650,00



49

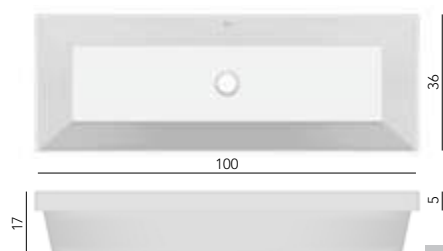

Borchia troppo pieno compresa
 Overflow cap included
 Anneau trop-plein inclus
 Beschlag für Überlaufschutz inklusive
 Tachón rebosadero incluido
 Перелив входит в комплект

PALLET QUANTITY - 100x120x200h: 24

PALLET QUANTITY - 80x120x200h: 16

BIOKER + 115,00

Art. 5154

TEOREMA 2.0 120x36S - 120 x 36 Cm - 26 Kg - 13,5 L.



Lavabo sottopiano
 Under-top washbasin
 Lavabo encastré par dessous
 Unterbauwaschbecken
 Lavabo bajo encimera
 Раковина умывальника под столешницу

WHITE 530,00

COLORS 780,00



Borchia troppo pieno compresa
 Overflow cap included
 Anneau trop-plein inclus
 Beschlag für Überlaufschutz inklusive
 Tachón rebosadero incluido
 Перелив входит в комплект

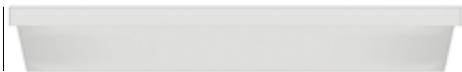

PALLET QUANTITY - 100x120x200h: 20
 PALLET QUANTITY - 80x120x200h: 16

BIOKER + 115,00

CONSOLE FOR WASHBASIN



ConSOLE per lavabo
 Console for washbasin
 Console pour lavabo
 Konsole für waschbecken
 Consolle para lavabo
 Подставка под раковину
 умывальника

Art. 10060 - L 58 P 44,5 H 76 Cm Per - For - Pour - Für - Para - Для: Art.: 5105

CR ● 670,00
NROP ● 710,00

Art. 10061 - L 78 P 44,5 H 76 Cm Per - For - Pour - Für - Para - Для: Art.: 5110

CR ● 670,00
NROP ● 710,00

Art. 10062 - L 98 P 44,5 H 76 Cm Per - For - Pour - Für - Para - Для: Art.: 5106/R-100/A - /B - Art.: 5119 - Art.: 5120 - Art.: 5124 - Art.: 5142

CR ● 780,00
NROP ● 810,00

Art. 10063 - L 118 P 44,5 H 76 Cm Per - For - Pour - Für - Para - Для: Art.: 5107/R-120/A - /B - Art.: 5121 - Art.: 5122 - Art.: 5125 - Art.: 5143

CR ● 780,00
NROP ● 810,00

Art. 10064 - L 58 P 42 H 76 Cm Per - For - Pour - Für - Para - Для: Art.: 5114 - Art.: 5117

CR ● 670,00
NROP ● 710,00

Art. 10065 - L 78 P 42 H 76 Cm Per - For - Pour - Für - Para - Для: Art.: 5115 - Art.: 5118 - Art.: 5123

CR ● 670,00
NROP ● 710,00

TOWEL BAR



Porta asciugamani
Towel bar
Porte-Serviettes
Handtuchhalter
Toallero
Держатель полотенец

Art. 10041 - L 45 Cm

Per - For - Pour - Für - Para - Для: Art.: 5104

CR **180,00**
NROP **205,00**

Art. 10042 - L 59 Cm

Per - For - Pour - Für - Para - Для: Art.: 5105 - Art.: 5114 - Art.: 5117 - Art.: 5116 (x2)

CR **220,00**
NROP **240,00**

Art. 10043 - L 79 Cm

Per - For - Pour - Für - Para - Для: Art.: 5110 - Art.: 5115 - Art.: 5118 - Art.: 5123

CR **235,00**
NROP **255,00**

Art. 10045 - L 98 Cm

Per - For - Pour - Für - Para - Для: Art.: 5106/R-100/A - /B - Art.: 5119 - Art.: 5120 - Art.: 5124 - Art.: 5142

CR **235,00**
NROP **255,00**

Art. 10046 - L 118 Cm

Per - For - Pour - Für - Para - Для: Art.: 5107/R-120/A - /B - Art.: 5121 - Art.: 5122 - Art.: 5125 - Art.: 5143

CR **235,00**
NROP **255,00**

Art. 10034



Piletta lavabo da 1"1/4
con troppo pieno integrato
1"1/4 washbasin waste with overflow
Bonde lavabo de 1"1/4 avec trop-plein intégré
Waschbeckenabfluss 1"1/4 mit integriertem Überlaufschutz
Desagüe lavabo de 1"1/4 con rebosadero integrado
Донный клапан для умывальника 1"1/4 с интегрированным переливом

CR **200,00**
NROP **220,00**

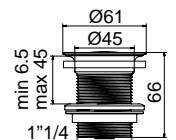

Art. 10010/C



Scarico automatico 1"1/4 click-clack, tappo grande
Automatic pop-waste 1" 1/4 click-clack, big plug
Bonde clic-clac, grand debit
Automatischer ablauf click-clack, crosser stöpsel
Valvula automática 1" 1/4 click-clack, tapón grande
Слив автоматический: клапан 1"1/4, большая пробка

CR / NROP + WHITE **105,00**

ORS + WHITE **145,00**

CR / NROP + COLORS **130,00**

ORS + COLORS **175,00**

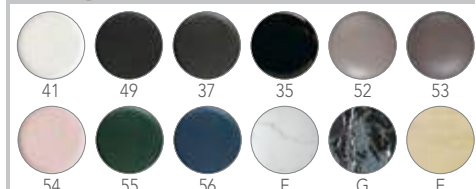



TEOREMA 2.0-PLUS
60R
Art. 5146



TEOREMA 2.0 PLUS
60 SHELF DX®
Art. 5147



TEOREMA 2.0 PLUS
60 SHELF SX®
Art. 5148



TEOREMA 2.0 PLUS
80 DOUBLE SHELF®
Art. 5151



TEOREMA 2.0 PLUS
80 SHELF DX®
Art. 5149



TEOREMA 2.0 PLUS
80 SHELF SX®
Art. 5150



WC BIDET ABBINABILI

MATCHING WCS AND BIDETS - WC ET BIDET COMBINABLES
KOMBINIERBARE WCS UND BIDETS - WC BIDÉ COMBINABLES
УНИТАЗЫ БИДЕ КОМБИНИРУЕМЫЕ

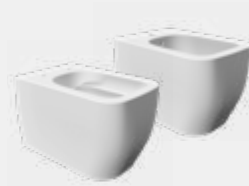

P_20

Art. 5126/TW - 52 x 36 - TWIST
Art. 5126/CL - 52 x 36 - CLEAN FLUSH
Art. 5127 - 52 x 36



P_21

Art. 5138/CL - 55 x 36 - CLEAN FLUSH
Art. 5139 - 55 x 36



P_22

Art. 5140/CL - 66 x 36 - CLEAN FLUSH
Art. 5141 - 35 x 15 - CISTERN



P_126

Art. 8701 - 50 x 35
Art. 8702 - 50 x 35



P_48

Art. 5201/TW - 50,5 x 36 - TWIST
Art. 5202 - 50,5 x 36



P_58

Art. 8812 - 53,5 x 36
Art. 8812/CL - 53,5 x 36 - CLEAN FLUSH
Art. 8813 - 53,5 x 36
Art. 8815 - 40 x 29 - KIDS WC



P_8

Art. 5520/CL - 50,5 x 36 - CLEAN FLUSH
Art. 5521 - 50,5 x 36



P_11

Art. 5524/CL - 45 x 35 - CLEAN FLUSH
Art. 5525 - 45 x 35



P_9

Art. 5522 - 54,5 x 36
Art. 5522/CL - 54,5 x 36 - CLEAN FLUSH
Art. 5523 - 54,5 x 36



P_10

Art. 5526/CL - 66 x 36 - CLEAN FLUSH
Art. 5527 - 36 x 15 - CISTERN

Art. 5146

TEOREMA 2.0 PLUS 60R - 60 x 53,5 Cm - 17 Kg - 8 L.

- MODELLO REGISTRATO -
- REGISTERED MODEL -



#

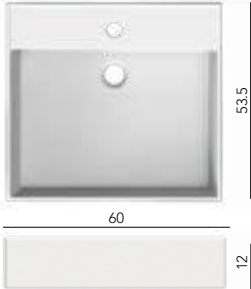

Lavabo da appoggio o sospeso

Lay-on or wall-mounted washbasin

Lavabo à poser ou suspendu

Aufsatz-oder Hängewaschbecken

Lavabo de apoyo o suspendido

Раковина умывальника накладная или подвесная

Fissaggi a muro compresi - Borchia troppo pieno compresa

Wall attachments included - Overflow cap included

Fixations murales incluses - Anneau trop-plein inclus

Wandbefestigungen inklusive - Beschlag für Überlaufschutz inklusive

Fijación pared incluida - Tachón rebosadero incluido

Настенные крепления входят в комплект - Перелив входит в комплект

PALLET QUANTITY - 100x120x200h: 34

PALLET QUANTITY - 80x120x200h: 26

BIOKER + 115,00

WHITE

470,00

COLORS

720,00



Art. 5147

TEOREMA 2.0 PLUS 60 SHELF DX® - 60 x 53,5 Cm - 18 Kg - 5 L.

- MODELLO REGISTRATO -
- REGISTERED MODEL -



#

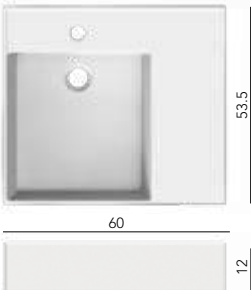

Lavabo da appoggio o sospeso

Lay-on or wall-mounted washbasin

Lavabo à poser ou suspendu

Aufsatz-oder Hängewaschbecken

Lavabo de apoyo o suspendido

Раковина умывальника накладная или подвесная

Fissaggi a muro compresi - Borchia troppo pieno compresa

Wall attachments included - Overflow cap included

Fixations murales incluses - Anneau trop-plein inclus

Wandbefestigungen inklusive - Beschlag für Überlaufschutz inklusive

Fijación pared incluida - Tachón rebosadero incluido

Настенные крепления входят в комплект - Перелив входит в комплект

PALLET QUANTITY - 100x120x200h: 34

PALLET QUANTITY - 80x120x200h: 26

BIOKER + 115,00

WHITE

470,00

COLORS

720,00



Art. 5148

TEOREMA 2.0 PLUS 60 SHELF SX® - 60 x 53,5 Cm - 18 Kg - 5 L.

- MODELLO REGISTRATO -
- REGISTERED MODEL -



#

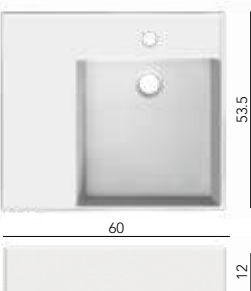

Lavabo da appoggio o sospeso

Lay-on or wall-mounted washbasin

Lavabo à poser ou suspendu

Aufsatz-oder Hängewaschbecken

Lavabo de apoyo o suspendido

Раковина умывальника накладная или подвесная

Fissaggi a muro compresi - Borchia troppo pieno compresa

Wall attachments included - Overflow cap included

Fixations murales incluses - Anneau trop-plein inclus

Wandbefestigungen inklusive - Beschlag für Überlaufschutz inklusive

Fijación pared incluida - Tachón rebosadero incluido

Настенные крепления входят в комплект - Перелив входит в комплект

PALLET QUANTITY - 100x120x200h: 34

PALLET QUANTITY - 80x120x200h: 26

BIOKER + 115,00

WHITE

470,00

COLORS

720,00

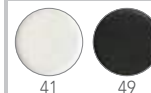

Art. 5151

TEOREMA 2.0 PLUS 80 DOUBLE SHELF® - 80 x 53,5 Cm - 24 Kg - 5,5 L.

- MODELLO REGISTRATO -
- REGISTERED MODEL -



Lavabo da appoggio o sospeso

Lay-on or wall-mounted washbasin

Lavabo à poser ou suspendu

Aufsatz-oder Hängewaschbecken

Lavabo de apoyo o suspendido

Раковина умывальника накладная или подвесная

WHITE 500,00

COLORS 720,00

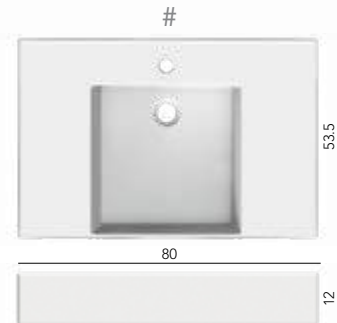

Fissaggi a muro compresi - Borchia troppo pieno compresa

Wall attachments included - Overflow cap included
Fixations murales incluses - Anneau trop-plein inclus
Wandbefestigungen inklusive - Beschlag für Überlaufschutz inklusive
Fijación pared incluida - Tachón rebosadero incluido
Настенные крепления входят в комплект - Перелив входит в комплект

PALLET QUANTITY - 100x120x200h: 28

PALLET QUANTITY - 80x120x200h: 21

BIOKER + 115,00



Art. 5149

TEOREMA 2.0 PLUS 80 SHELF DX® - 80 x 53,5 Cm - 24 Kg - 6,5 L.

- MODELLO REGISTRATO -
- REGISTERED MODEL -



Lavabo da appoggio o sospeso

Lay-on or wall-mounted washbasin

Lavabo à poser ou suspendu

Aufsatz-oder Hängewaschbecken

Lavabo de apoyo o suspendido

Раковина умывальника накладная или подвесная

WHITE 500,00

COLORS 720,00

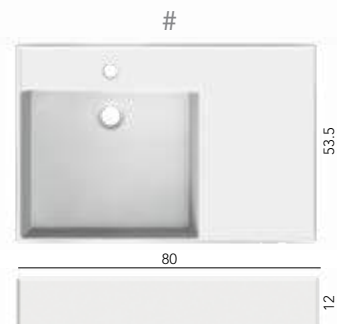

Fissaggi a muro compresi - Borchia troppo pieno compresa

Wall attachments included - Overflow cap included
Fixations murales incluses - Anneau trop-plein inclus
Wandbefestigungen inklusive - Beschlag für Überlaufschutz inklusive
Fijación pared incluida - Tachón rebosadero incluido
Настенные крепления входят в комплект - Перелив входит в комплект

PALLET QUANTITY - 100x120x200h: 28

PALLET QUANTITY - 80x120x200h: 21

BIOKER + 115,00



Art. 5150

TEOREMA 2.0 PLUS 80 SHELF SX® - 80 x 53,5 Cm - 24 Kg - 6,5 L.

- MODELLO REGISTRATO -
- REGISTERED MODEL -



Lavabo da appoggio o sospeso

Lay-on or wall-mounted washbasin

Lavabo à poser ou suspendu

Aufsatz-oder Hängewaschbecken

Lavabo de apoyo o suspendido

Раковина умывальника накладная или подвесная

WHITE 500,00

COLORS 720,00

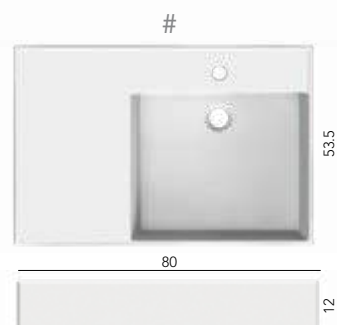

Fissaggi a muro compresi - Borchia troppo pieno compresa

Wall attachments included - Overflow cap included
Fixations murales incluses - Anneau trop-plein inclus
Wandbefestigungen inklusive - Beschlag für Überlaufschutz inklusive
Fijación pared incluida - Tachón rebosadero incluido
Настенные крепления входят в комплект - Перелив входит в комплект

PALLET QUANTITY - 100x120x200h: 28

PALLET QUANTITY - 80x120x200h: 21

BIOKER + 115,00



Art. 10034



Piletta lavabo da 1"1/4
 con troppo pieno integrato
 1"1/4 washbasin waste with overflow
 Bonde lavabo de 1"1/4 avec trop-plein intégré
 Waschbeckenabfluss 1"1/4 mit integriertem Überlaufschutz
 Desagüe lavabo de 1"1/4 con rebosadero integrado
 Донный клапан для умывальника 1"1/4 с интегрированным переливом

CR ● 200,00
 NROP ● 220,00

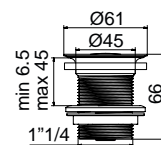

Art. 10010/C



Scarico automatico 1"1/4 click-clack, tappo grande
 Automatic pop-waste 1" 1/4 click-clack, big plug
 Bonde clic-clac, grand debit
 Automatischer ablauf click-clack, crosser stöpsel
 Valvula automática 1" 1/4 click-clack, tapón grande
 Слив автоматический: клапан 1"1/4, большая пробка

CR ● / NROP ● + WHITE 105,00

ORS ● + WHITE 145,00

CR ● / NROP ● + COLORS 130,00

ORS ● + COLORS 175,00





GLAM
TWIST HUNG WC
Art. 5201



GLAM
HUNG BIDET
Art. 5202



GLAM 22
Art. 1809



GLAM Ø33
Art. 1808



GLAM Ø39
Art. 1807



GLAM 40
Art. 1806



GLAM 56
Art. 1804



GLAM 76
Art. 1803



GLAM 56/R
Art. 1802



GLAM 76/R
Art. 1801



GLAM 55/S
Art. 1811



GLAM 75/S
Art. 1812



GLAM 95/S
Art. 1813



GLAM 95/SB
Art. 1813B



GLAM 56/A
Art. 1805



GLAM 56/AR
Art. 1810



WC BIDET ABBINABILI

MATCHING WCS AND BIDETS - WC ET BIDET COMBINABLES
KOMBINIERBARE WCS UND BIDETS - WC BIDÉ COMBINABLES
УНИТАЗЫ БИДЕ КОМБИНИРУЕМЫЕ



P_8

Art. 5520/CL - 50,5 x 36 - CLEAN FLUSH
Art. 5521 - 50,5 x 36



P_11

Art. 5524/CL - 45 x 35 - CLEAN FLUSH
Art. 5525 - 45 x 35



P_9

Art. 5522 - 54,5 x 36
Art. 5522/CL - 54,5 x 36 - CLEAN FLUSH
Art. 5523 - 54,5 x 36



P_10

Art. 5526/CL - 66 x 36 - CLEAN FLUSH
Art. 5527 - 36 x 15 - CISTERN

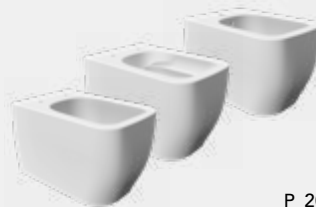

P_20

Art. 5126/TW - 52 x 36 - TWIST
Art. 5126/CL - 52 x 36 - CLEAN FLUSH
Art. 5127 - 52 x 36



P_21

Art. 5138/CL - 55 x 36 - CLEAN FLUSH
Art. 5139 - 55 x 36



P_22

Art. 5140/CL - 66 x 36 - CLEAN FLUSH
Art. 5141 - 35 x 15 - CISTERN



P_126

Art. 8701 - 50 x 35
Art. 8702 - 50 x 35



P_58

Art. 8812 - 53,5 x 36
Art. 8812/CL - 53,5 x 36 - CLEAN FLUSH
Art. 8813 - 53,5 x 36
Art. 8815 - 40 x 29 - KIDS WC

Art. 5201/TW

GLAM TWIST HUNG WC - 50,5 x 36 Cm - 20 Kg



Wc Sospeso
Wall-mounted WC
Cuvette suspendue
Hänge-WC
Inodoro suspendido
Унитаз подвесной



WHITE 450,00

COLORS 700,00

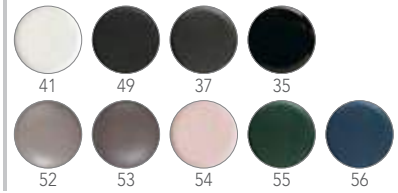

BICOLORS 800,00

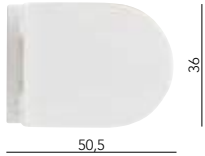
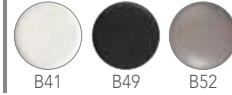

Senza staffe - Aggiungere fissaggio rapido
Without fixing set - Add quick fixing kit
Sans équerres - Ajouter fixation rapide
Ohne Befestigungselemente und Bügel - Schnellverbindung hinzufügen
Sin soportes - Añadir fijación rápida
Без скоб - Дополнительное набор быстрого монтажа

PALLET QUANTITY - 100x120x200h: 20+CW

PALLET QUANTITY - 80x120x200h: 14+CW

BIOKER + 115,00

#



Art. 5202

GLAM HUNG BIDET - 50,5 x 36 Cm - 16 Kg



Bidet sospeso
Wall-mounted bidet
Bidet suspendu
Hänge-Bidet
Bidet suspendido
Биде подвесное

WHITE 360,00

COLORS 595,00

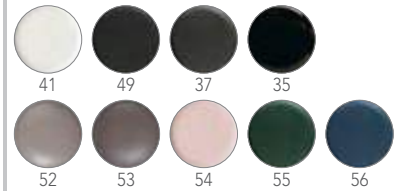

Senza staffe - Aggiungere fissaggio rapido
Borchia troppo pieno compresa
Without fixing set - Add quick fixing kit
Overflow cap included
Sans équerres - Ajouter fixation rapide
Anneau trop-plein inclus
Ohne Befestigungselemente und Bügel - Schnellverbindung hinzufügen
Beschlag für Überlaufschutz inklusive
Sin soportes - Añadir fijación rápida
Tachón rebosadero incluido
Без скоб - Дополнительное набор быстрого монтажа
Перелив входит в комплект

PALLET QUANTITY - 100x120x200h: 24

PALLET QUANTITY - 80x120x200h: 16

BIOKER + 115,00

#



+ Art. 10050/A - STANDARD

20,00

+ Art. 10050/B - WB9 2.0 CLICK SYSTEM

25,00



Fissaggio Rapido per Sanitari
Quick fixing kit for sanitary fittings
Fixation rapide pour sanitaires
Schnellverbindung für Sanitäranlagen
Fijación rápida para sanitarios
Набор быстрого монтажа для сантехники



Fissaggio Rapido per Sanitari
Quick fixing kit for sanitary fittings
Fixation rapide pour sanitaires
Schnellverbindung für Sanitäranlagen
Fijación rápida para sanitarios
Набор быстрого монтажа для сантехники

<p>Art. 5530/A</p> 	<p>GLAM SLIM SEAT COVER</p> <p>Sedile per Wc in termoindurente Seat cover Wc in thermosetting resin Abattant wc en matière thermodurcissable WC-deckel Duroplax Asiento para inodoro en material termoenduracido Сиденье унитаза из термореактивного полимера</p> <p>Con cerniere cromate - Sgancio rapido With chromed Kit - Rapid lift system Charnières chromées - Décrochage rapide Mit scharniere chrom - Schnellbefestigung Bisagras cromadas - Desenganche rápido С хромированными шарнирами - Быстрое отсоединение</p>	<p>WHITE 140,00</p>
---	---	-----------------------------------

<p>Art. 5530/B</p> 	<p>GLAM SLIM SEAT COVER</p> <p>Sedile per Wc in termoindurente Seat cover Wc in thermosetting resin Abattant wc en matière thermodurcissable WC-deckel Duroplax Asiento para inodoro en material termoenduracido Сиденье унитаза из термореактивного полимера</p> <p>Con cerniera rallentata - Sgancio rapido With soft close system - Rapid lift system Charnieres avec frein de chute - Décrochage rapide Mit sanft abgebremsten scharnieren - Schnellbefestigung Con caída amortiguada - Desenganche rápido С микролифтом - Быстрое отсоединение</p>	<p>WHITE 185,00</p> <p>COLORS 260,00</p> 
---	--	--

<p>Art. 10005</p> 	<p>FIXING SET</p> <p>Staffe di montaggio Wc e bidet Fixing attachments for Wc and bidet Supports de montage pour cuvette et bidets suspendus Montagebügel Für Hänge-wc und bidet Soportes de montaje inodoro y bidé Монтажные кронштейны для унитаза и биде</p>	<p>-- 70,00</p>
--	---	-------------------------------

Art. 1809

GLAM 22 - 22,5 x 22,5 Cm - 2 Kg - 2,5 L.



Lavabo da appoggio
Lay-on washbasin
Lavabo à poser
Aufsatzwaschbecken
Lavabo de apojo
Раковина умывальника накладная

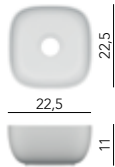

Senza troppo pieno - Consigliata piletta Art. 10034
Without overflow - Waste Art. 10034 recommended
Sans trop-plein - Bonde Art. 10034 conseillée
Ohne überlauf - Abfluss Art. 10034 empfohlen
Sin rebosadero - Recomendado desagüe Art. 10034
Без пробки перелива - Рекомендуется донный клапан арт. 10034

PALLET QUANTITY - 100x120x200h: 184
PALLET QUANTITY - 80x120x200h: 58

BIOKER + 115,00

WHITE 195,00

COLORS 370,00



DecorLAB - DecorART 415,00

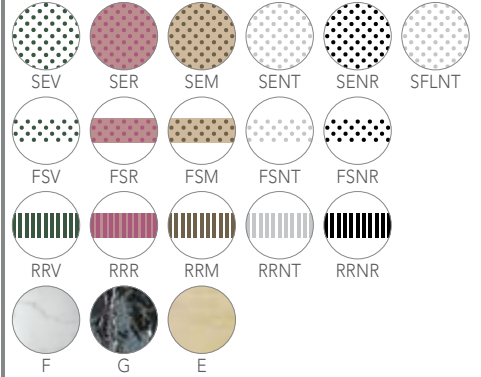

Art. 1808

GLAM Ø33 - Ø33 Cm - 4,2 Kg - 3,5 L.



Lavabo da appoggio
Lay-on washbasin
Lavabo à poser
Aufsatzwaschbecken
Lavabo de apojo
Раковина умывальника накладная

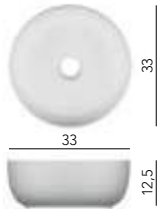

Senza troppo pieno - Consigliata piletta Art. 10034
Without overflow - Waste Art. 10034 recommended
Sans trop-plein - Bonde Art. 10034 conseillée
Ohne überlauf - Abfluss Art. 10034 empfohlen
Sin rebosadero - Recomendado desagüe Art. 10034
Без пробки перелива - Рекомендуется донный клапан арт. 10034

PALLET QUANTITY - 100x120x200h: 102
PALLET QUANTITY - 80x120x200h: 86

BIOKER + 115,00

WHITE 195,00

COLORS 385,00



DecorLAB - DecorART 415,00

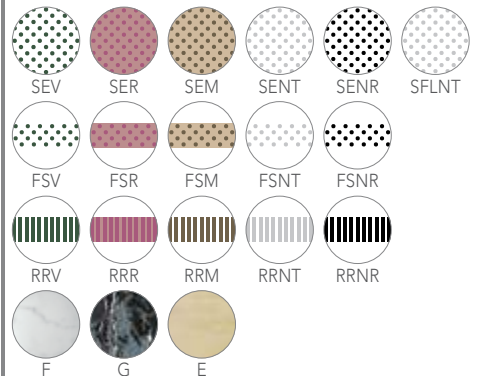

Art. 1807

GLAM Ø39 - Ø39 Cm - 6,2 Kg - 8,5 L.



Lavabo da appoggio
Lay-on washbasin
Lavabo à poser
Aufsatzwaschbecken
Lavabo de apojo
Раковина умывальника накладная

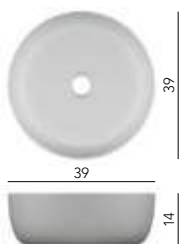

Senza troppo pieno - Consigliata piletta Art. 10034
Without overflow - Waste Art. 10034 recommended
Sans trop-plein - Bonde Art. 10034 conseillée
Ohne überlauf - Abfluss Art. 10034 empfohlen
Sin rebosadero - Recomendado desagüe Art. 10034
Без пробки перелива - Рекомендуется донный клапан арт. 10034

PALLET QUANTITY - 100x120x200h: 68
PALLET QUANTITY - 80x120x200h: 40

BIOKER + 115,00

WHITE 230,00

COLORS 415,00

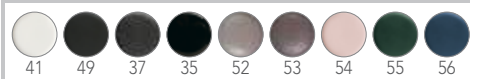

DecorLAB - DecorART 450,00

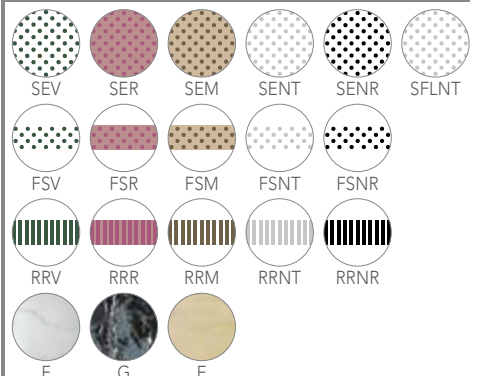

Art. 1806

GLAM 40 - 40 x 40 Cm - 6,5 Kg - 12,5 L.

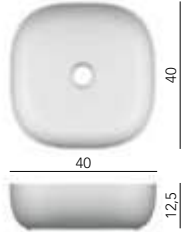

Lavabo da appoggio
Lay-on washbasin
Lavabo à poser
Aufsatzwaschbecken
Lavabo de apojo
Раковина умывальника накладная

Senza troppo pieno - Consigliata piletta Art. 10034
Without overflow - Waste Art. 10034 recommended
Sans trop-plein - Bonde Art. 10034 conseillée
Ohne überlauf - Abfluss Art. 10034 empfohlen
Sin rebosadero - Recomendado desagüe Art. 10034
Без пробки перелива - Рекомендуется донный клапан арт. 10034

PALLET QUANTITY - 100x120x200h: 68
PALLET QUANTITY - 80x120x200h: 40

BIOKER + 115,00

WHITE 260,00

COLORS 450,00

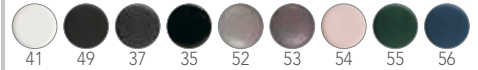

DecorLAB - DecorART 500,00

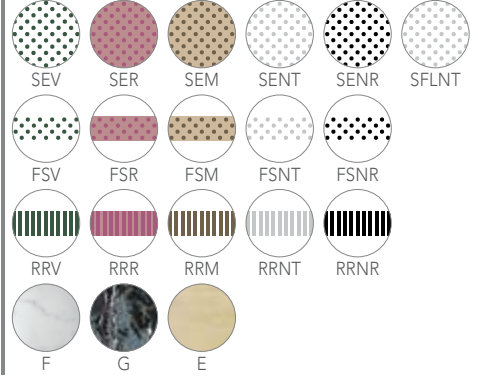

Art. 1804

GLAM 56 - 56 x 39 Cm - 9,6 Kg - 19,6 L.

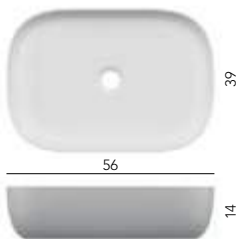

Lavabo da appoggio
Lay-on washbasin
Lavabo à poser
Aufsatzwaschbecken
Lavabo de apojo
Раковина умывальника накладная

Senza troppo pieno - Consigliata piletta Art. 10034
Without overflow - Waste Art. 10034 recommended
Sans trop-plein - Bonde Art. 10034 conseillée
Ohne überlauf - Abfluss Art. 10034 empfohlen
Sin rebosadero - Recomendado desagüe Art. 10034
Без пробки перелива - Рекомендуется донный клапан арт. 10034

PALLET QUANTITY - 100x120x200h: 40
PALLET QUANTITY - 80x120x200h: 32

BIOKER + 115,00

WHITE 365,00

COLORS 560,00

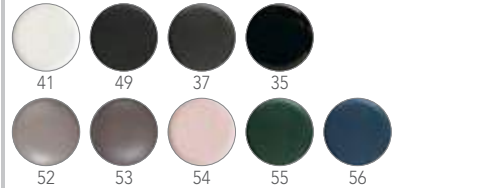

DecorLAB - DecorART 610,00

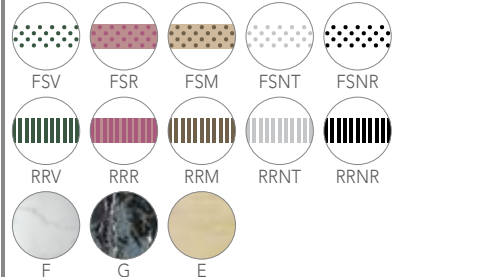

Art. 1803

GLAM 76 - 76 x 39 Cm - 12,8 Kg - 26,5 L.



Lavabo da appoggio
Lay-on washbasin
Lavabo à poser
Aufsatzwaschbecken
Lavabo de apojo
Раковина умывальника накладная

Senza troppo pieno - Consigliata piletta Art. 10034
Without overflow - Waste Art. 10034 recommended
Sans trop-plein - Bonde Art. 10034 conseillée
Ohne überlauf - Abfluss Art. 10034 empfohlen
Sin rebosadero - Recomendado desagüe Art. 10034
Без пробки перелива - Рекомендуется донный клапан арт. 10034

PALLET QUANTITY - 100x120x200h: 32
PALLET QUANTITY - 80x120x200h: 28

BIOKER + 115,00

WHITE 410,00

COLORS 625,00



DecorART 700,00

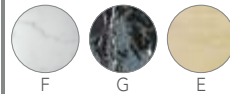

Art. 1802

GLAM 56/R - 56 x 38 Cm - 11 Kg - 14,6 L.



Lavabo da appoggio
Lay-on washbasin
Lavabo à poser
Aufsatzwaschbecken
Lavabo de apoyo
Раковина умывальника накладная

WHITE 365,00

COLORS 560,00

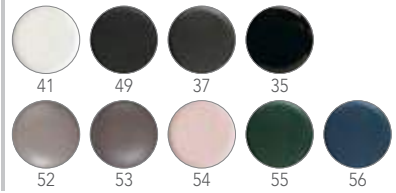

DecorART 610,00

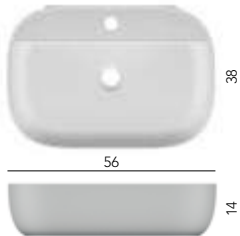
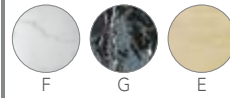

Senza troppo pieno - Consigliata piletta Art. 10034
Without overflow - Waste Art. 10034 recommended
Sans trop-plein - Bonde Art. 10034 conseillée
Ohne überlauf - Abfluss Art. 10034 empfohlen
Sin rebosadero - Recomendado desagüe Art. 10034
Без пробки перелива - Рекомендуется донный клапан арт. 10034

PALLET QUANTITY - 100x120x200h: 40
PALLET QUANTITY - 80x120x200h: 32

BIOKER + 115,00

Art. 1801

GLAM 76/R - 76 x 38 Cm - 14,6 Kg - 19 L.



Lavabo da appoggio
Lay-on washbasin
Lavabo à poser
Aufsatzwaschbecken
Lavabo de apoyo
Раковина умывальника накладная

WHITE 410,00

COLORS 625,00



DecorART 700,00

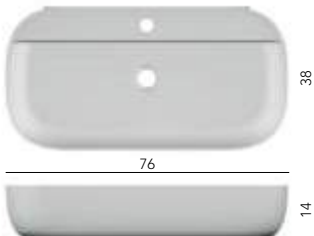
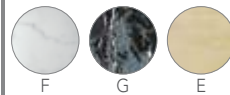

Senza troppo pieno - Consigliata piletta Art. 10034
Without overflow - Waste Art. 10034 recommended
Sans trop-plein - Bonde Art. 10034 conseillée
Ohne überlauf - Abfluss Art. 10034 empfohlen
Sin rebosadero - Recomendado desagüe Art. 10034
Без пробки перелива - Рекомендуется донный клапан арт. 10034

PALLET QUANTITY - 100x120x200h: 32
PALLET QUANTITY - 80x120x200h: 28

BIOKER + 115,00

Art. 1811

GLAM 55/S - 55 x 42 Cm - 14,2 Kg - 10,5 L.



Lavabo da appoggio o sospeso
Lay-on or wall-mounted washbasin
Lavabo à poser ou suspendu
Aufsatz- oder Hängewaschbecken
Lavabo de apoyo o suspendido
Раковина умывальника накладная или подвесная

WHITE 370,00

COLORS 580,00

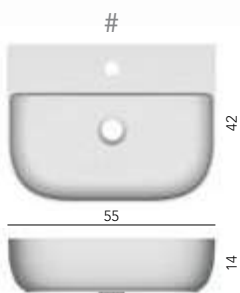
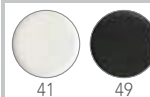

Fissaggi a muro compresi - Borchia troppo pieno compresa
Wall attachments included - Overflow cap included
Fixations murales incluses - Anneau trop-plein inclus
Wandbefestigungen inklusive - Beschlag für Überlaufschutz inklusive
Fijación pared incluida - Tachón rebosadero incluido
Настенные крепления входят в комплект - Перелив входит в комплект

PALLET QUANTITY - 100x120x200h: 40
PALLET QUANTITY - 80x120x200h: 32

BIOKER + 115,00

Art. 1812

GLAM 75/S - 75 x 42 Cm - 19 Kg - 14 L.



Lavabo da appoggio o sospeso
Lay-on or wall-mounted washbasin
Lavabo à poser ou suspendu
Aufsatz-oder Hängewaschbecken
Lavabo de apoyo o suspendido
Раковина умывальника накладная или подвесная

WHITE 415,00

COLORS 630,00



#

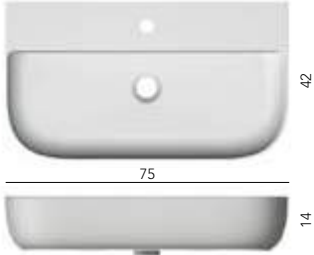

Fissaggi a muro compresi - Borchia troppo pieno compresa
Wall attachments included - Overflow cap included
Fixations murales incluses - Anneau trop-plein inclus
Wandbefestigungen inklusive - Beschlag für Überlaufschutz inklusive
Fijación pared incluida - Tachón rebosadero incluido
Настенные крепления входят в комплект - Перелив входит в комплект

PALLET QUANTITY - 100x120x200h: 32
PALLET QUANTITY - 80x120x200h: 28

BIOKER + 115,00

Art. 1813

GLAM 95/S - 95 x 42 Cm - 24,2 Kg - 18,2 L.



Lavabo da appoggio o sospeso
Lay-on or wall-mounted washbasin
Lavabo à poser ou suspendu
Aufsatz-oder Hängewaschbecken
Lavabo de apoyo o suspendido
Раковина умывальника накладная или подвесная

WHITE 550,00

COLORS 750,00



#

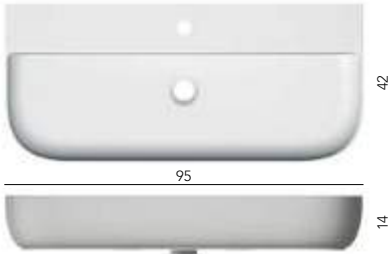

Fissaggi a muro compresi - Borchia troppo pieno compresa
Wall attachments included - Overflow cap included
Fixations murales incluses - Anneau trop-plein inclus
Wandbefestigungen inklusive - Beschlag für Überlaufschutz inklusive
Fijación pared incluida - Tachón rebosadero incluido
Настенные крепления входят в комплект - Перелив входит в комплект

PALLET QUANTITY - 100x120x200h: 20
PALLET QUANTITY - 80x120x200h: 16

BIOKER + 115,00

Art. 1813B

GLAM 95/SB - 95 x 42 Cm - 24,2 Kg - 18,2 L.



Lavabo da appoggio o sospeso
Lay-on or wall-mounted washbasin
Lavabo à poser ou suspendu
Aufsatz-oder Hängewaschbecken
Lavabo de apoyo o suspendido
Раковина умывальника накладная или подвесная

WHITE 550,00

COLORS 750,00

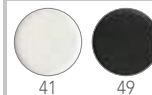

#



Fissaggi a muro compresi - Borchia troppo pieno compresa
Wall attachments included - Overflow cap included
Fixations murales incluses - Anneau trop-plein inclus
Wandbefestigungen inklusive - Beschlag für Überlaufschutz inklusive
Fijación pared incluida - Tachón rebosadero incluido
Настенные крепления входят в комплект - Перелив входит в комплект

PALLET QUANTITY - 100x120x200h: 20
PALLET QUANTITY - 80x120x200h: 16

BIOKER + 115,00

Art. 1805 **GLAM 56/A** - 56 x 39 Cm - 9,4 Kg - 16 L.



Lavabo da incasso
 Built-in washbasin
 Lavabo encastré
 Einbauwaschbecken
 Lavabo de encaje
 Раковина умывальника встраиваемая

WHITE **380,00**

COLORS **590,00**

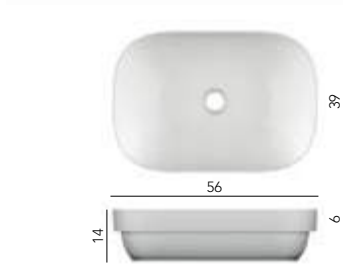

Senza troppo pieno - Consigliata piletta Art. 10034
 Without overflow - Waste Art. 10034 recommended
 Sans trop-plein - Bonde Art. 10034 conseillée
 Ohne überlauf - Abfluss Art. 10034 empfohlen
 Sin rebosadero - Recomendado desagüe Art. 10034
 Без пробки перелива - Рекомендуется донный клапан арт. 10034

PALLET QUANTITY - 100x120x200h: 40
 PALLET QUANTITY - 80x120x200h: 32

BIOKER + 115,00

DecorLAB - DecorART **620,00**

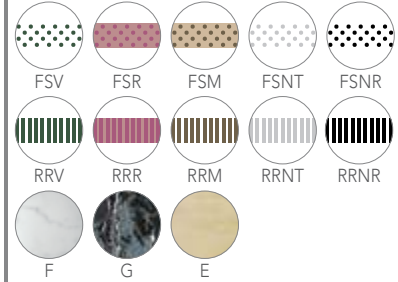

Art. 1810 **GLAM 56/AR** - 56 x 39 Cm - 11,5 Kg - 12,5 L.



Lavabo da incasso
 Built-in washbasin
 Lavabo encastré
 Einbauwaschbecken
 Lavabo de encaje
 Раковина умывальника встраиваемая

WHITE **380,00**

COLORS **590,00**

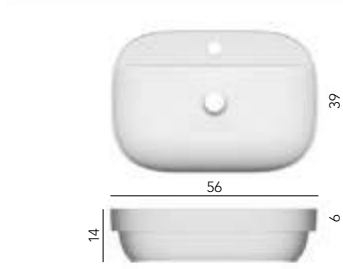

Senza troppo pieno - Consigliata piletta Art. 10034
 Without overflow - Waste Art. 10034 recommended
 Sans trop-plein - Bonde Art. 10034 conseillée
 Ohne überlauf - Abfluss Art. 10034 empfohlen
 Sin rebosadero - Recomendado desagüe Art. 10034
 Без пробки перелива - Рекомендуется донный клапан арт. 10034

PALLET QUANTITY - 100x120x200h: 40
 PALLET QUANTITY - 80x120x200h: 32

BIOKER + 115,00

DecorART **620,00**

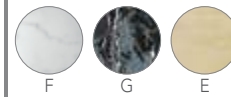

Art. 10034



Piletta lavabo da 1"1/4
 con troppo pieno integrato
 1"1/4 washbasin waste with overflow
 Bonde lavabo de 1"1/4 avec trop-plein intégré
 Waschbeckenabfluss 1"1/4 mit integriertem Überlaufschutz
 Desagüe lavabo de 1"1/4 con rebosadero integrado
 Донный клапан для умывальника 1"1/4 с интегрированным переливом

CR **200,00**

NROP **220,00**

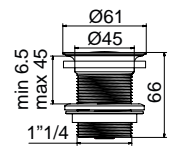

Art. 10010/C **CR / NROP + WHITE** **105,00**



Scarico automatico 1"1/4 click-clack, tappo grande
 Automatic pop-waste 1" 1/4 click-clack, big plug
 Bonde clic-clac, grand debit
 Automatischer ablauf click-clack, crosser stöpsel
 Valvula automática 1" 1/4 click-clack, tapón grande
 Слив автоматический: клапан 1"1/4, большая пробка

ORS + WHITE **145,00**

CR / NROP + COLORS **130,00**

ORS + COLORS **175,00**

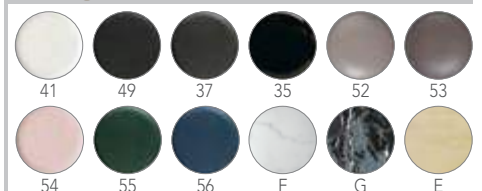



BUCKET CLEAN FLUSH HUNG WC
Art. 8812/CL



BUCKET HUNG BIDET
Art. 8813



BUCKET HUNG WC
Art. 8812



BUCKET HUNG WC - KIDS
Art. 8815



BUCKET 30
Art. 8801



BUCKET 40
Art. 8803



BUCKET 30R
Art. 8802



BUCKET 40R
Art. 8804



BUCKET 35 h 22
Art. 8808



BUCKET 42 h 22
Art. 8807



BUCKET 35 h 6
Art. 8811



BUCKET 42 h 6
Art. 8810



BUCKET 50 h 6
Art. 8809



BUCKET ACCESSORIES



WC BIDET ABBINABILI

MATCHING WCS AND BIDETS - WC ET BIDET COMBINABLES
KOMBINIERBARE WCS UND BIDETS - WC BIDÉ COMBINABLES
УНИТАЗЫ БИДЕ КОМБИНИРУЕМЫЕ



P_8

Art. 5520/CL - 50,5 x 36 - CLEAN FLUSH
Art. 5521 - 50,5 x 36



P_11

Art. 5524/CL - 45 x 35 - CLEAN FLUSH
Art. 5525 - 45 x 35



P_9

Art. 5522 - 54,5 x 36
Art. 5522/CL - 54,5 x 36 - CLEAN FLUSH
Art. 5523 - 54,5 x 36



P_10

Art. 5526/CL - 66 x 36 - CLEAN FLUSH
Art. 5527 - 36 x 15 - CISTERN

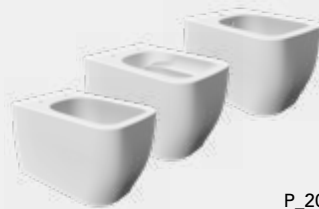

P_20

Art. 5126/TW - 52 x 36 - TWIST
Art. 5126/CL - 52 x 36 - CLEAN FLUSH
Art. 5127 - 52 x 36



P_21

Art. 5138/CL - 55 x 36 - CLEAN FLUSH
Art. 5139 - 55 x 36



P_22

Art. 5140/CL - 66 x 36 - CLEAN FLUSH
Art. 5141 - 35 x 15 - CISTERN



P_48

Art. 5201/TW - 50,5 x 36 - TWIST
Art. 5202 - 50,5 x 36



P_126

Art. 8701 - 50 x 35
Art. 8702 - 50 x 35

Art. 8812/CL

BUCKET CLEAN FLUSH HUNG WC - 53,5 x 36 Cm - 20 Kg



Wc Sospeso
Wall-mounted WC
Cuvette suspendue
Hänge-WC
Inodoro suspendido
Унитаз подвесной



WHITE

360,00



36

53,5

#



42

Senza staffe - Aggiungere fissaggio rapido
Without fixing set - Add quick fixing kit
Sans équerres - Ajouter fixation rapide
Ohne Befestigungselemente und Bügel - Schnellverbindung hinzufügen
Sin soportes - Añadir fijación rápida
Без скоб - Дополнительное набор быстрого монтажа

PALLET QUANTITY - 100x120x200h: 20+CW

PALLET QUANTITY - 80x120x200h: 14+CW

BIOKER + 115,00

Art. 8812

BUCKET HUNG WC - 53,5 x 36 Cm - 20 Kg



Wc Sospeso
Wall-mounted WC
Cuvette suspendue
Hänge-WC
Inodoro suspendido
Унитаз подвесной



WHITE

360,00



36

53,5

#



42

Senza staffe - Aggiungere fissaggio rapido
Without fixing set - Add quick fixing kit
Sans équerres - Ajouter fixation rapide
Ohne Befestigungselemente und Bügel - Schnellverbindung hinzufügen
Sin soportes - Añadir fijación rápida
Без скоб - Дополнительное набор быстрого монтажа

PALLET QUANTITY - 100x120x200h: 20+CW

PALLET QUANTITY - 80x120x200h: 14+CW

BIOKER + 115,00

Art. 8813

BUCKET HUNG BIDET - 53,5 x 36 Cm - 20 Kg



Bidet sospeso
Wall-mounted bidet
Bidet suspendu
Hänge-Bidet
Bidet suspendido
Биде подвесное

WHITE

360,00

Senza staffe - Aggiungere fissaggio rapido
Borchia troppo pieno compresa
Without fixing set - Add quick fixing kit
Overflow cap included
Sans équerres - Ajouter fixation rapide
Anneau trop-plein inclus
Ohne Befestigungselemente und Bügel - Schnellverbindung hinzufügen
Beschlag für Überlaufschutz inklusive
Sin soportes - Añadir fijación rápida
Tachón rebosadero incluido
Без скоб - Дополнительное набор быстрого монтажа
Перелив входит в комплект

PALLET QUANTITY - 100x120x200h: 24

PALLET QUANTITY - 80x120x200h: 16

BIOKER + 115,00



36

53,5

#



42

Art. 8815
BUCKET HUNG WC - KIDS - 40 x 29 Cm - 20 Kg

Wc Sospeso
Wall-mounted WC
Cuvette suspendue
Hänge-WC
Inodoro suspendido
Унитаз подвесной

WHITE
360,00

Senza staffe - Aggiungere fissaggio rapido
Without fixing set - Add quick fixing kit
Sans équerres - Ajouter fixation rapide
Ohne befestigungselemente und bügel - Schnellverbindung hinzufügen
Sin soportes - Añadir fijación rápida
Без скоб - Дополнительное набор быстрого монтажа

PALLET QUANTITY - 100x120x200h: 40+CW
PALLET QUANTITY - 80x120x200h: 30+CW

BIOKER + 115,00
+ Art. 10050/A - STANDARD
20,00
+ Art. 10050/B - WB9 2.0 CLICK SYSTEM
25,00

Fissaggio Rapido per Sanitari
Quick fixing kit for sanitary fittings
Fixation rapide pour sanitaires
Schnellverbindung für Sanitäranlagen
Fijación rápida para sanitarios
Набор быстрого монтажа для сантехники

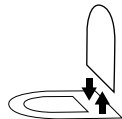

Fissaggio Rapido per Sanitari
Quick fixing kit for sanitary fittings
Fixation rapide pour sanitaires
Schnellverbindung für Sanitäranlagen
Fijación rápida para sanitarios
Набор быстрого монтажа для сантехники

Art. 8814/A
BUCKET SEAT COVER

Sedile per Wc in termoindurente
Seat cover Wc in termosetting resin
Abattant wc en matière thermodurcissable
WC-deckel Duroplas
Asiento para inodoro en material termoenduracido
Сиденье унитаза из термореактивного полимера

WHITE
140,00

Con cerniere cromate - Sgancio rapido
With chromed Kit - Rapid lift system
Charnières chromées - Décrochage rapide
Mit scharniere chrom - Schnellbefestigung
Bisagras cromadas - Desenganche rápido
С хромированными шарнирами - Быстрое отсоединение

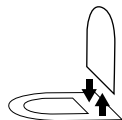
Art. 8814/B
BUCKET SEAT COVER

Sedile per Wc in termoindurente
Seat cover Wc in termosetting resin
Abattant wc en matière thermodurcissable
WC-deckel Duroplas
Asiento para inodoro en material termoenduracido
Сиденье унитаза из термореактивного полимера

WHITE
185,00

Con cerniera rallentata - Sgancio rapido
With soft close system - Rapid lift system
Charnières avec frein de chute - Décrochage rapide
Mit sanft abgebremsten scharnieren - Schnellbefestigung
Con caída amortiguada - Desenganche rápido
С микролифтом - Быстрое отсоединение

Art. 8816/A
BUCKET SEAT COVER - KIDS

Sedile per Wc
Seat cover Wc
Abattant wc
WC-deckel
Asiento para inodoro
Сиденье унитаза

WHITE
140,00

Con cerniere cromate
With chromed Kit
Charnières chromées
Mit scharniere chrom
Bisagras cromadas
С хромированными шарнирами

Art. 10005
FIXING SET

Staffe di montaggio Wc e bidet
Fixing attachments for Wc and bidet
Supports de montage pour cuvette et bidets suspendus
Montagebügel Für Hänge-wc und bidet
Soportes de montaje inodoro y bidé
Монтажные кронштейны для унитаза и биде

--
70,00

Art. 8801

- MODELLO REGISTRATO -
- REGISTERED MODEL -

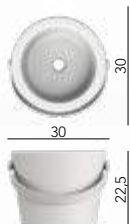

BUCKET 30 - Ø30 Cm - 8 Kg - 3,3 L.

Lavabo da appoggio
Lay-on washbasin
Lavabo à poser
Aufsatzwaschbecken
Lavabo de apoyo
Раковина умывальника накладная

Senza troppo pieno - Consigliata piletta Art. 10034
Without overflow - Waste Art. 10034 recommended
Sans trop-plein - Bonde Art. 10034 conseillée
Ohne überlauf - Abfluss Art. 10034 empfohlen
Sin rebosadero - Recomendado desagüe Art. 10034
Без пробки перелива - Рекомендуется донный клапан арт. 10034

Se non specificato al momento dell'ordine - Porta asciugamani cromo
If not specified when order is made - chrome towel rail
Si non précisé à la commande - porte-serviettes chromé
Sofern bei der bestellung nicht angegeben - handtuchhalter aus chrom
Si no se especifica otra cosa en el momento del pedido - toallero cromo
Если не указано на момент заказа - держатель полотенец хромированный

PALLET QUANTITY - 100x120x200h: 51

PALLET QUANTITY - 80x120x200h: 32

BIOKER + 115,00

WHITE 445,00

Art. 8801 - Towel rail CHROMIUM

WHITE 470,00

Art. 8801BS / 8801NS - Towel rail BS / NROP

BUCKET DECORATIONS 740,00

Art. 8801 - Towel rail CHROMIUM

BUCKET DECORATIONS 760,00

Art. 8801BS / 8801NS - Towel rail BS / NROP

DecorLAB 740,00

Art. 8801 - Towel rail CHROMIUM

DecorLAB 760,00

Art. 8801BS / 8801NS - Towel rail BS / NROP

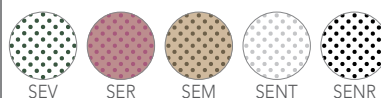

Art. 8802

- MODELLO REGISTRATO -
- REGISTERED MODEL -

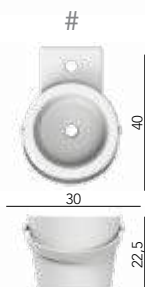

BUCKET 30R - 30 x 40 Cm - 12 Kg - 3,3 L.

Lavabo da appoggio o sospeso
Lay-on or wall-mounted washbasin
Lavabo à poser ou suspendu
Aufsatz- oder Hängewaschbecken
Lavabo de apoyo o suspendido
Раковина умывальника накладная или подвесная

Senza troppo pieno - Consigliata piletta Art. 10034
Without overflow - Waste Art. 10034 recommended
Sans trop-plein - Bonde Art. 10034 conseillée
Ohne überlauf - Abfluss Art. 10034 empfohlen
Sin rebosadero - Recomendado desagüe Art. 10034
Без пробки перелива - Рекомендуется донный клапан арт. 10034

Se non specificato al momento dell'ordine - Porta asciugamani cromo
If not specified when order is made - chrome towel rail
Si non précisé à la commande - porte-serviettes chromé
Sofern bei der bestellung nicht angegeben - handtuchhalter aus chrom
Si no se especifica otra cosa en el momento del pedido - toallero cromo
Если не указано на момент заказа - держатель полотенец хромированный

PALLET QUANTITY - 100x120x200h: 51

PALLET QUANTITY - 80x120x200h: 32

BIOKER + 115,00

WHITE 500,00

Art. 8802 - Towel rail CHROMIUM

WHITE 525,00

Art. 8802BS / 8802NS - Towel rail BS / NROP

BUCKET DECORATIONS 740,00

Art. 8802 - Towel rail CHROMIUM

BUCKET DECORATIONS 760,00

Art. 8802BS / 8802NS - Towel rail BS / NROP

DecorLAB 740,00

Art. 8802 - Towel rail CHROMIUM

DecorLAB 760,00

Art. 8802BS / 8802NS - Towel rail BS / NROP



Art. 8803

- MODELLO REGISTRATO -
- REGISTERED MODEL -

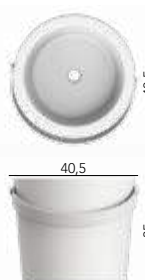

BUCKET 40 - Ø40,5 Cm - 16 Kg - 6 L.

Lavabo da appoggio
Lay-on washbasin
Lavabo à poser
Aufsatzwaschbecken
Lavabo de apoyo
Раковина умывальника накладная

Senza troppo pieno - Consigliata piletta Art. 10034
Without overflow - Waste Art. 10034 recommended
Sans trop-plein - Bonde Art. 10034 conseillée
Ohne überlauf - Abfluss Art. 10034 empfohlen
Sin rebosadero - Recomendado desagüe Art. 10034
Без пробки перелива - Рекомендуется донный клапан арт. 10034

Se non specificato al momento dell'ordine - Porta asciugamani cromo
If not specified when order is made - chrome towel rail
Si non précisé à la commande - porte-serviettes chromé
Sofern bei der bestellung nicht angegeben - handtuchhalter aus chrom
Si no se especifica otra cosa en el momento del pedido - toallero cromo
Если не указано на момент заказа - держатель полотенец хромированный

PALLET QUANTITY - 100x120x200h: 20

PALLET QUANTITY - 80x120x200h: 14

BIOKER + 115,00

WHITE 500,00

Art. 8803 - Towel rail CHROMIUM

WHITE 525,00

Art. 8803BS / 8803NS - Towel rail BS / NROP

BUCKET DECORATIONS 780,00

Art. 8803 - Towel rail CHROMIUM

BUCKET DECORATIONS 805,00

Art. 8803BS / 8803NS - Towel rail BS / NROP

DecorLAB 780,00

Art. 8803 - Towel rail CHROMIUM

DecorLAB 805,00

Art. 8803BS / 8803NS - Towel rail BS / NROP

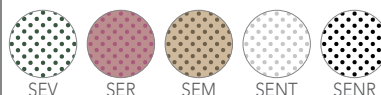

Art. 8804

BUCKET 40R - 40,5 x 54 Cm - 24 Kg - 6 L.

- MODELLO REGISTRATO -
- REGISTERED MODEL -



Lavabo da appoggio o sospeso
Lay-on or wall-mounted washbasin
Lavabo à poser ou suspendu
Aufsatz- oder Hängewaschbecken
Lavabo de apoyo o suspendido
Раковина умывальника накладная или подвесная

Senza troppo pieno - Consigliata piletta Art. 10034
Without overflow - Waste Art. 10034 recommended
Sans trop-plein - Bonde Art. 10034 conseillée
Ohne überlauf - Abfluss Art. 10034 empfohlen
Sin rebosadero - Recomendado desagüe Art. 10034
Без пробки перелива - Рекомендуется донный клапан арт. 10034

Se non specificato al momento dell'ordine - Porta asciugamani cromo
If not specified when order is made - chrome towel rail
Si non précisé à la commande - porte-serviettes chromé
Sofern bei der bestellung nicht angegeben - handtuchhalter aus chrom
Si no se especifica otra cosa en el momento del pedido - toallero cromo
Если не указано на момент заказа - держатель полотенец хромированный

PALLET QUANTITY - 100x120x200h: 20
PALLET QUANTITY - 80x120x200h: 14

BIOKER + 115,00

WHITE 560,00

Art. 8804 - Towel rail CHROMIUM

WHITE 580,00

Art. 8804BS / 8804NS - Towel rail BS / NROP

BUCKET DECORATIONS 780,00

Art. 8804 - Towel rail CHROMIUM

BUCKET DECORATIONS 805,00

Art. 8804BS / 8804NS - Towel rail BS / NROP

DecorLAB 780,00

Art. 8804 - Towel rail CHROMIUM

DecorLAB 805,00

Art. 8804BS / 8804NS - Towel rail BS / NROP



#

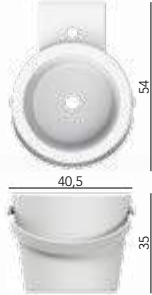

Art. 8808

BUCKET 35 H22 - Ø35 Cm - 12 Kg - 9 L.

Lavabo da appoggio
Lay-on washbasin
Lavabo à poser
Aufsatzwaschbecken
Lavabo de apoyo
Раковина умывальника накладная

Senza troppo pieno - Consigliata piletta Art. 10034
Without overflow - Waste Art. 10034 recommended
Sans trop-plein - Bonde Art. 10034 conseillée
Ohne überlauf - Abfluss Art. 10034 empfohlen
Sin rebosadero - Recomendado desagüe Art. 10034
Без пробки перелива - Рекомендуется донный клапан арт. 10034

PALLET QUANTITY - 100x120x200h: 51
PALLET QUANTITY - 80x120x200h: 32

BIOKER + 115,00

WHITE 315,00

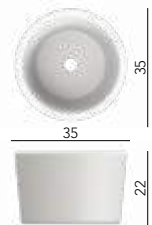

DecorLAB 770,00



Art. 8807

BUCKET 42 H22 - Ø42 Cm - 14 Kg - 12 L.

Lavabo da appoggio
Lay-on washbasin
Lavabo à poser
Aufsatzwaschbecken
Lavabo de apoyo
Раковина умывальника накладная

Senza troppo pieno - Consigliata piletta Art. 10034
Without overflow - Waste Art. 10034 recommended
Sans trop-plein - Bonde Art. 10034 conseillée
Ohne überlauf - Abfluss Art. 10034 empfohlen
Sin rebosadero - Recomendado desagüe Art. 10034
Без пробки перелива - Рекомендуется донный клапан арт. 10034

PALLET QUANTITY - 100x120x200h: 28
PALLET QUANTITY - 80x120x200h: 16

BIOKER + 115,00

WHITE 315,00

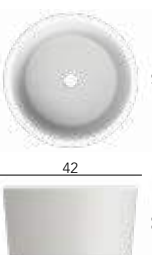

DecorLAB 770,00



Art. 8811

BUCKET 35 H6 - Ø35 Cm - 7 Kg - 2 L.



Lavabo da appoggio
Lay-on washbasin
Lavabo à poser
Aufsatzwaschbecken
Lavabo de apojo
Раковина умывальника накладная

WHITE

220,00

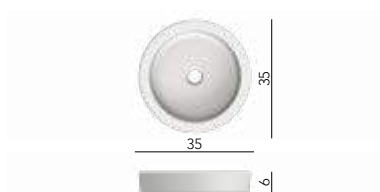

Senza troppo pieno - Consigliata piletta Art. 10034
Without overflow - Waste Art. 10034 recommended
Sans trop-plein - Bonde Art. 10034 conseillée
Ohne überlauf - Abfluss Art. 10034 empfohlen
Sin rebosadero - Recomendado desagüe Art. 10034
Без пробки перелива - Рекомендуется донный клапан арт. 10034

PALLET QUANTITY - 100x120x200h: 104

PALLET QUANTITY - 80x120x200h: 100

BIOKER + 115,00

DecorLAB

460,00

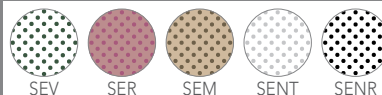

Art. 8810

BUCKET 42 H6 - Ø42 Cm - 9 Kg - 3 L.



Lavabo da appoggio
Lay-on washbasin
Lavabo à poser
Aufsatzwaschbecken
Lavabo de apojo
Раковина умывальника накладная

WHITE

235,00

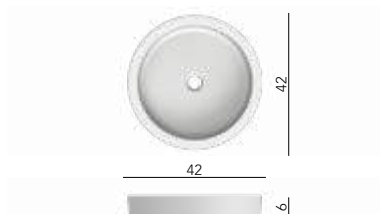

Senza troppo pieno - Consigliata piletta Art. 10034
Without overflow - Waste Art. 10034 recommended
Sans trop-plein - Bonde Art. 10034 conseillée
Ohne überlauf - Abfluss Art. 10034 empfohlen
Sin rebosadero - Recomendado desagüe Art. 10034
Без пробки перелива - Рекомендуется донный клапан арт. 10034

PALLET QUANTITY - 100x120x200h: 66

PALLET QUANTITY - 80x120x200h: 50

BIOKER + 115,00

DecorLAB

470,00



Art. 8809

BUCKET 50 H6 - Ø50 Cm - 12 Kg - 4 L.



Lavabo da appoggio
Lay-on washbasin
Lavabo à poser
Aufsatzwaschbecken
Lavabo de apojo
Раковина умывальника накладная

WHITE

265,00

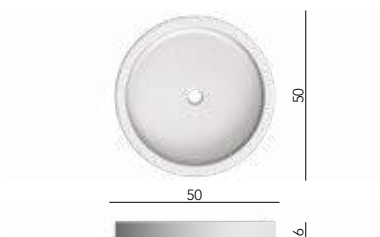

Senza troppo pieno - Consigliata piletta Art. 10034
Without overflow - Waste Art. 10034 recommended
Sans trop-plein - Bonde Art. 10034 conseillée
Ohne überlauf - Abfluss Art. 10034 empfohlen
Sin rebosadero - Recomendado desagüe Art. 10034
Без пробки перелива - Рекомендуется донный клапан арт. 10034

PALLET QUANTITY - 100x120x200h: 66

PALLET QUANTITY - 80x120x200h: 50

BIOKER + 115,00

DecorLAB

500,00

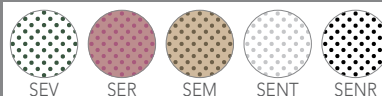

Art. 10034



Piletta lavabo da 1"1/4
 con troppo pieno integrato
 1"1/4 washbasin waste with overflow
 Bonde lavabo de 1"1/4 avec trop-plein intégré
 Waschbeckenabfluss 1"1/4 mit integriertem Überlaufschutz
 Desagüe lavabo de 1"1/4 con rebosadero integrado
 Донный клапан для умывальника 1"1/4 с интегрированным переливом

CR 200,00

NROP 220,00

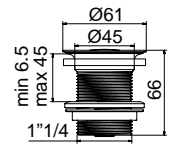

Art. 10010/C



Scarico automatico 1"1/4 click-clack, tappo grande
 Automatic pop-waste 1" 1/4 click-clack, big plug
 Bonde clic-clac, grand debit
 Automatischer ablauf click-clack, crosser stöpsel
 Valvula automática 1" 1/4 click-clack, tapón grande
 Слив автоматический: клапан 1"1/4, большая пробка

CR / NROP + WHITE 105,00

ORS + WHITE 145,00

Art. 8816



Porta sapone da muro
 Wall mounted soap dish
 Porte-savon mural
 Seifenschale für Wandmontage
 Porta jabón de pared
 Мыльница настенная

WHITE CHROME 146,00



Art. 8817



Porta spazzolino da muro
 Wall mounted tumbler
 Porte-brosses à dent mural
 Zahnbürstenbecher für Wandmontage
 Porta cepillo de pared
 Стакан для зубных щеток настенный

WHITE CHROME 146,00



Art. 8822



Portascopino da terra
 Freestanding toilet brush
 Porte-balayette au sol
 Freistehender WC-Bürstenständer
 Porta escobilla de suelo
 Туалетный ерш напольный

WHITE CHROME 168,00



Art. 8819



Appendiabiti
 Robe hook
 Porte manteau
 Kleiderhaken
 Perchero
 Вешалка для одежды

CHROME 90,00



BUCKET

Art. 8820

L60 Cm



Porta asciugamani
Towel bar
Porte-Serviettes
Handtuchhalter
Toallero
Держатель полотенец

CHROME**202,00****Art. 8821**

L30 Cm



Porta asciugamani
Towel bar
Porte-Serviettes
Handtuchhalter
Toallero
Держатель полотенец

CHROME**124,00****Art. 8818**

Porta rotolo da muro
Wall mounted toilet roll holder
Porte-rouleau WC mural
Toilettenpapierhalter für Wandmontage
Porta rollo de pared
Держатель рулона туалетной бумаги настенный

CHROME**101,00****Art. 8805**

Ø30 Cm

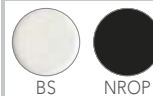

Porta asciugamani di ricambio Art. 8801 / 8802
Spare towel rail Art. 8801 / 8802
Porte-serviettes de rechange Réf. 8801 / 8802
Ersatz-Handtuchhalter Art. 8801 / 8802
Portatoallas de repuesto Art. 8801 / 8802
Запасная вешалка для полотенец Арт. 8801 / 8802

CHROME**157,00****WHITE / BLACK****180,00****Art. 8806**

Ø40 Cm



Porta asciugamani di ricambio Art. 8803 / 8804
Spare towel rail Art. 8803 / 8804
Porte-serviettes de rechange Réf. 8803 / 8804
Ersatz-Handtuchhalter Art. 8803 / 8804
Portatoallas de repuesto Art. 8803 / 8804
Запасная вешалка для полотенец Арт. 8803 / 8804

CHROME**180,00****WHITE / BLACK****202,00**



PLANET CLEAN FLUSH HUNG WC
Art. 8105/CL



PLANET HUNG BIDET
Art. 8106



PLANET HUNG WC
Art. 8105



PLANET WC
Art. 8401



PLANET BIDET
Art. 8403



PLANET CISTERN
Art. 8404



PLANET 66
Art. 8111



PLANET 48
Art. 8112



PLANET 67R
Art. 8109



PLANET 48R
Art. 8110



PLANET FLOOR-STANDING
Art. 8104

WC BIDET ABBINABILI

MATCHING WCS AND BIDETS - WC ET BIDET COMBINABLES
KOMBINIERBARE WCS UND BIDETS - WC BIDÉ COMBINABLES
УНИТАЗЫ БИДЕ КОМБИНИРУЕМЫЕ



P_8

Art. 5520/CL - 50,5 x 36 - CLEAN FLUSH
Art. 5521 - 50,5 x 36



P_11

Art. 5524/CL - 45 x 35 - CLEAN FLUSH
Art. 5525 - 45 x 35



P_9

Art. 5522 - 54,5 x 36
Art. 5522/CL - 54,5 x 36 - CLEAN FLUSH
Art. 5523 - 54,5 x 36



P_10

Art. 5526/CL - 66 x 36 - CLEAN FLUSH
Art. 5527 - 36 x 15 - CISTERN

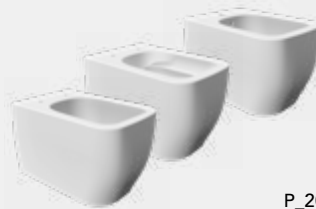

P_20

Art. 5126/TW - 52 x 36 - TWIST
Art. 5126/CL - 52 x 36 - CLEAN FLUSH
Art. 5127 - 52 x 36



P_21

Art. 5138/CL - 55 x 36 - CLEAN FLUSH
Art. 5139 - 55 x 36



P_22

Art. 5140/CL - 66 x 36 - CLEAN FLUSH
Art. 5141 - 35 x 15 - CISTERN



P_48

Art. 5201/TW - 50,5 x 36 - TWIST
Art. 5202 - 50,5 x 36



P_126

Art. 8701 - 50 x 35
Art. 8702 - 50 x 35



P_58

Art. 8812 - 53,5 x 36
Art. 8812/CL - 53,5 x 36 - CLEAN FLUSH
Art. 8813 - 53,5 x 36
Art. 8815 - 40 x 29 - KIDS WC

Art. 8105/CL

PLANET CLEAN FLUSH HUNG WC - 50 x 45 Cm - 22 Kg



Wc Sospeso
Wall-mounted WC
Cuvette suspendue
Hänge-WC
Inodoro suspendido
Унитаз подвесной



WHITE

360,00



45

50

#



47

Senza staffe - Aggiungere fissaggio rapido
Without fixing set - Add quick fixing kit
Sans équerres - Ajouter fixation rapide
Ohne Befestigungselemente und Bügel - Schnellverbindung hinzufügen
Sin soportes - Añadir fijación rápida
Без скоб - Дополнительное набор быстрого монтажа

PALLET QUANTITY - 100x120x200h: 16+CW

PALLET QUANTITY - 80x120x200h: 6+CW

BIOKER + 115,00

Art. 8105

PLANET HUNG WC - 50 x 45 Cm - 22 Kg



Wc Sospeso
Wall-mounted WC
Cuvette suspendue
Hänge-WC
Inodoro suspendido
Унитаз подвесной



WHITE

360,00



45

50

#



47

Senza staffe - Aggiungere fissaggio rapido
Without fixing set - Add quick fixing kit
Sans équerres - Ajouter fixation rapide
Ohne Befestigungselemente und Bügel - Schnellverbindung hinzufügen
Sin soportes - Añadir fijación rápida
Без скоб - Дополнительное набор быстрого монтажа

PALLET QUANTITY - 100x120x200h: 16+CW

PALLET QUANTITY - 80x120x200h: 6+CW

BIOKER + 115,00

Art. 8106

PLANET HUNG BIDET - 50 x 45 Cm - 22 Kg



Bidet sospeso
Wall-mounted bidet
Bidet suspendu
Hänge-Bidet
Bidet suspendido
Биде подвесное

WHITE

360,00



45

50

#



47

Senza staffe - Aggiungere fissaggio rapido
Borchia troppo pieno compresa
Without fixing set - Add quick fixing kit
Overflow cap included
Sans équerres - Ajouter fixation rapide
Anneau trop-plein inclus
Ohne Befestigungselemente und Bügel - Schnellverbindung hinzufügen
Beschlag für Überlaufschutz inklusive
Sin soportes - Añadir fijación rápida
Tachón rebosadero incluido
Без скоб - Дополнительное набор быстрого монтажа
Перелив входит в комплект

PALLET QUANTITY - 100x120x200h: 20

PALLET QUANTITY - 80x120x200h: 6

BIOKER + 115,00

+ Art. 10050/C - STANDARD

20,00



Fissaggio Rapido per Sanitari
 Quick fixing kit for sanitary fittings
 Fixation rapide pour sanitaires
 Schnellverbindung für Sanitäreanlagen
 Fijación rápida para sanitarios
 Набор быстрого монтажа для сантехники

Art. 8401

PLANET WC - 50 x 45 Cm - 23 Kg



Wc a terra
 Floor-mounted wc
 Cuvette au sol
 Bodenstehendes wc
 Inodoro a tierra
 Унитаз напольный



WHITE

360,00

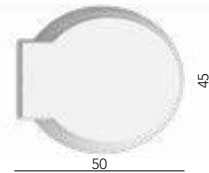

PALLET QUANTITY - 100x120x200h: 16+CW
 PALLET QUANTITY - 80x120x200h: 6+CW

BIOKER + 115,00

Art. 8403

PLANET BIDET - 50 x 45 Cm - 23 Kg



Bidet a terra
 Floor-mounted bidet
 Bidet au sol
 Bodenstehendes Bidet
 Bidet a tierra
 Биде напольное

WHITE

360,00



Borchia troppo pieno compresa
 Overflow cap included
 Anneau trop-plein inclus
 Beschlag für Überlaufschutz inklusive
 Tachón rebosadero incluido
 Перелив входит в комплект

PALLET QUANTITY - 100x120x200h: 16
 PALLET QUANTITY - 80x120x200h: 6

BIOKER + 115,00

Art. 8404
PLANET CISTERN - 38 x 14,5 x h95,5 Cm - 18 Kg
Cassetta a muro, comprensiva di batteria a doppio flusso Geberit 6/4,5 lt
WHITE
590,00

Wall cistern, inclusive of flushing system Geberit dual-flush 6/4,5 l

Réservoir de chasse mural avec mécanisme de chasse à double flux Geberit 6/4,5 L

Wandspülkasten, einschließlich Batterie mit Geberit-Doppelspülung 6/4,5 lt

Cisterna de pared, incluido mecanismo doble flujo Geberit 6/4,5 lt

Бачок сливной внутривентный с сифоном двухрежимного слива Geberit, 6/4,5л

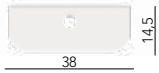

PALLET QUANTITY - 100x120x200h: 20

PALLET QUANTITY - 80x120x200h: 16

BIOKER + 115,00
Art. 8108/A
PLANET SEAT COVER
Sedile per Wc in termoindurente
WHITE
140,00

Seat cover Wc in termosetting resin

Abattant wc en matière thermodurcissable

WC-deckel Duroplas

Asiento para inodoro en material termoenduracido

Сиденье унитаза из термореактивного полимера

Con cerniere cromate

With chromed Kit

Charnières chromées

Mit scharniere chrom

Bisagras cromadas

С хромированными шарнирами

Art. 8108/B
PLANET SEAT COVER
Sedile per Wc in termoindurente
WHITE
185,00

Seat cover Wc in termosetting resin

Abattant wc en matière thermodurcissable

WC-deckel Duroplas

Asiento para inodoro en material termoenduracido

Сиденье унитаза из термореактивного полимера

Con cerniera rallentata

With soft close system

Charnieres avec frein de chute

Mit sanft abgebremsten scharnieren

Con caída amortiguada

С микролифтом

Art. 10005
FIXING SET
Staffe di montaggio Wc e bidet
--
70,00

Fixing attachments for Wc and bidet

Supports de montage pour cuvette et bidets suspendus

Montagebügel Für Hänge-wc und bidet

Soportes de montaje inodoro y bidé

Монтажные кронштейны для унитаза и биде



Art. 8109

PLANET 67R - 67 x 47 Cm - 15 Kg - 6 L.



Lavabo da appoggio o sospeso

Lay-on or wall-mounted washbasin

Lavabo à poser ou suspendu

Aufsatz-oder Hängewaschbecken

Lavabo de apoyo o suspendido

Раковина умывальника накладная или подвесная

WHITE

350,00

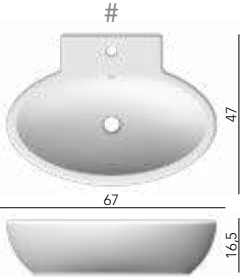

Fissaggi a muro compresi - Borchia troppo pieno compresa

Wall attachments included - Overflow cap included

Fixations murales incluses - Anneau trop-plein inclus

Wandbefestigungen inklusive - Beschlag für Überlaufschutz inklusive

Fijación pared incluida - Tachón rebosadero incluido

Настенные крепления входят в комплект - Перелив входит в комплект

PALLET QUANTITY - 100x120x200h: 20

PALLET QUANTITY - 80x120x200h: 15

BIOKER + 115,00

Art. 8110

PLANET 48R - 48 x 47 Cm - 12 Kg - 5 L.



Lavabo da appoggio o sospeso

Lay-on or wall-mounted washbasin

Lavabo à poser ou suspendu

Aufsatz-oder Hängewaschbecken

Lavabo de apoyo o suspendido

Раковина умывальника накладная или подвесная

WHITE

325,00



Fissaggi a muro compresi - Borchia troppo pieno compresa

Wall attachments included - Overflow cap included

Fixations murales incluses - Anneau trop-plein inclus

Wandbefestigungen inklusive - Beschlag für Überlaufschutz inklusive

Fijación pared incluida - Tachón rebosadero incluido

Настенные крепления входят в комплект - Перелив входит в комплект

PALLET QUANTITY - 100x120x200h: 50

PALLET QUANTITY - 80x120x200h: 28

BIOKER + 115,00

Art. 8111
PLANET 66 - 66 x 39 Cm - 14 Kg - 6 L.

Lavabo da appoggio

Lay-on washbasin

Lavabo à poser

Aufsatzwaschbecken

Lavabo de apoyo

Раковина умывальника накладная

WHITE
325,00

Senza troppo pieno - Consigliata piletta Art. 10034

Without overflow - Waste Art. 10034 recommended

Sans trop-plein - Bonde Art. 10034 conseillée

Ohne überlauf - Abfluss Art. 10034 empfohlen

Sin rebosadero - Recomendado desagüe Art. 10034

Без пробки перелива - Рекомендуется донный клапан арт. 10034

PALLET QUANTITY - 100x120x200h: 31

PALLET QUANTITY - 80x120x200h: 24

BIOKER + 115,00
Art. 8112
PLANET 48 - 48 x 39 Cm - 10 Kg - 5 L.

Lavabo da appoggio

Lay-on washbasin

Lavabo à poser

Aufsatzwaschbecken

Lavabo de apoyo

Раковина умывальника накладная

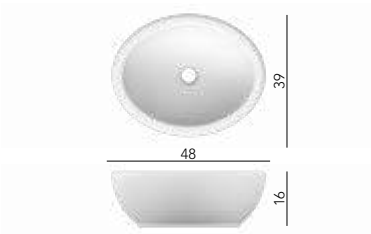
WHITE
310,00

Senza troppo pieno - Consigliata piletta Art. 10034

Without overflow - Waste Art. 10034 recommended

Sans trop-plein - Bonde Art. 10034 conseillée

Ohne überlauf - Abfluss Art. 10034 empfohlen

Sin rebosadero - Recomendado desagüe Art. 10034

Без пробки перелива - Рекомендуется донный клапан арт. 10034

PALLET QUANTITY - 100x120x200h: 40

PALLET QUANTITY - 80x120x200h: 28

BIOKER + 115,00

Art. 8104

PLANET FLOOR-STANDING - Ø54 x 105 Cm - 58 Kg - 5 L.



Lavabo a terra da appoggio

Floor-standing washbasin

Lavabo au sol

Standwaschbecken

Lavabo al suelo de apoyo

Раковина умывальника напольная

WHITE

1.950,00



Borchia troppo pieno compressa

Overflow cap included

Anneau trop-plein inclus

Beschlag für Überlaufschutz inklusive

Tachón rebosadero incluido

Перелив входит в комплект

PALLET QUANTITY - 100x120x200h: 3

PALLET QUANTITY - 80x120x200h: 2

BIOKER + 115,00

Art. 10034



Piletta lavabo da 1"1/4

con troppo pieno integrato

1"1/4 washbasin waste with overflow

Bonde lavabo de 1"1/4 avec trop-plein intégré

Waschbeckenabfluss 1"1/4 mit integriertem Überlaufschutz

Desagüe lavabo de 1"1/4 con rebosadero integrado

Донный клапан для умывальника 1"1/4 с интегрированным переливом

CR ●

200,00

NROP ●

220,00

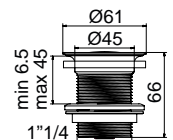

Art. 10010/C



Scarico automatico 1"1/4 click-clack, tappo grande

Automatic pop-waste 1" 1/4 click-clack, big plug

Bonde clic-clac, grand debit

Automatischer ablauf click-clack, crosser stöpsel

Valvula automática 1" 1/4 click-clack, tapón grande

Слив автоматический: клапан 1"1/4, большая пробка

CR ● / **NROP** ● + **WHITE** **105,00**

ORS ● + **WHITE**

145,00

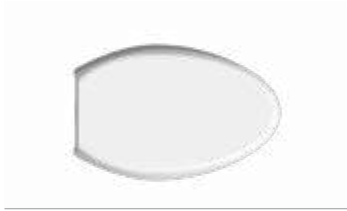

MOAI HUNG WC
Art. 8604



MOAI HUNG BIDET
Art. 8605



MOAI WC
Art. 8606



MOAI BIDET
Art. 8607



MOAI 55R
Art. 8610



MOAI 71
Art. 8601



MOAI 71R
Art. 8602



MOAI FLOOR-STANDING
Art. 8603

WC BIDET ABBINABILI

MATCHING WCS AND BIDETS - WC ET BIDET COMBINABLES
KOMBINIERBARE WCS UND BIDETS - WC BIDÉ COMBINABLES
УНИТАЗЫ БИДЕ КОМБИНИРУЕМЫЕ



P_8

Art. 5520/CL - 50,5 x 36 - CLEAN FLUSH
Art. 5521 - 50,5 x 36



P_11

Art. 5524/CL - 45 x 35 - CLEAN FLUSH
Art. 5525 - 45 x 35



P_9

Art. 5522 - 54,5 x 36
Art. 5522/CL - 54,5 x 36 - CLEAN FLUSH
Art. 5523 - 54,5 x 36



P_10

Art. 5526/CL - 66 x 36 - CLEAN FLUSH
Art. 5527 - 36 x 15 - CISTERN

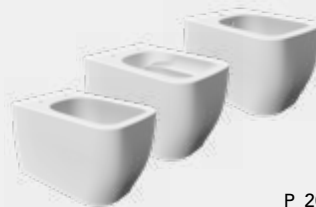

P_20

Art. 5126/TW - 52 x 36 - TWIST
Art. 5126/CL - 52 x 36 - CLEAN FLUSH
Art. 5127 - 52 x 36



P_21

Art. 5138/CL - 55 x 36 - CLEAN FLUSH
Art. 5139 - 55 x 36



P_22

Art. 5140/CL - 66 x 36 - CLEAN FLUSH
Art. 5141 - 35 x 15 - CISTERN



P_48

Art. 5201/TW - 50,5 x 36 - TWIST
Art. 5202 - 50,5 x 36



P_126

Art. 8701 - 50 x 35
Art. 8702 - 50 x 35



P_58

Art. 8812 - 53,5 x 36
Art. 8812/CL - 53,5 x 36 - CLEAN FLUSH
Art. 8813 - 53,5 x 36
Art. 8815 - 40 x 29 - KIDS WC

Art. 8604

MOAI HUNG WC - 55 x 41 Cm - 22 Kg



Wc Sospeso
Wall-mounted WC
Cuvette suspendue
Hänge-WC
Inodoro suspendido
Унитаз подвесной

WHITE

360,00

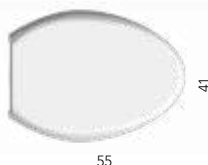

Senza staffe - Aggiungere fissaggio rapido
Without fixing set - Add quick fixing kit
Sans équerres - Ajouter fixation rapide
Ohne Befestigungselemente und Bügel - Schnellverbindung hinzufügen
Sin soportes - Añadir fijación rápida
Без скоб - Дополнительное набор быстрого монтажа

PALLET QUANTITY - 100x120x200h: 20+CW

PALLET QUANTITY - 80x120x200h: 14+CW

BIOKER + 115,00



Art. 8605

MOAI HUNG BIDET - 55 x 41 Cm - 22 Kg



Bidet sospeso
Wall-mounted bidet
Bidet suspendu
Hänge-Bidet
Bidet suspendido
Биде подвесное

WHITE

360,00



Senza staffe - Aggiungere fissaggio rapido
Borchia troppo pieno compresa
Without fixing set - Add quick fixing kit
Overflow cap included
Sans équerres - Ajouter fixation rapide
Anneau trop-plein inclus
Ohne Befestigungselemente und Bügel - Schnellverbindung hinzufügen
Beschlag für Überlaufschutz inklusive
Sin soportes - Añadir fijación rápida
Tachón rebosadero incluido
Без скоб - Дополнительное набор быстрого монтажа
Перелив входит в комплект

PALLET QUANTITY - 100x120x200h: 24

PALLET QUANTITY - 80x120x200h: 16

BIOKER + 115,00



+ Art. 10050/A - STANDARD

20,00



Fissaggio Rapido per Sanitari
Quick fixing kit for sanitary fittings
Fixation rapide pour sanitaires
Schnellverbindung für Sanitäreanlagen
Fijación rápida para sanitarios
Набор быстрого монтажа для сантехники

Art. 8606
MOAI WC - 55 x 41 Cm - 23 Kg

Wc a terra
Floor-mounted wc
Cuvette au sol
Bodenstehendes wc
Inodoro a tierra
Унитаз напольный

WHITE
360,00

PALLET QUANTITY - 100x120x200h: 15+CW
PALLET QUANTITY - 80x120x200h: 14+CW

BIOKER + 115,00
Art. 8607
MOAI BIDET - 55 x 41 Cm - 23 Kg

Bidet a terra
Floor-mounted bidet
Bidet au sol
Bodenstehendes Bidet
Bidet a tierra
Биде напольное

WHITE
360,00

Borchia troppo pieno compresa
Overflow cap included
Anneau trop-plein inclus
Beschlag für Überlaufschutz inklusive
Tachón rebosadero incluido
Перелив входит в комплект

PALLET QUANTITY - 100x120x200h: 20
PALLET QUANTITY - 80x120x200h: 16

BIOKER + 115,00
Art. 8609/A
MOAI SEAT COVER

Sedile per Wc in termoindurente
Seat cover Wc in termosetting resin
Abattant wc en matière thermodurcissable
WC-deckel Duroplas
Asiento para inodoro en material termoenduracido
Сиденье унитаза из термореактивного полимера

WHITE
140,00

Con cerniere cromate
With chromed Kit
Charnières chromées
Mit scharniere chrom
Bisagras cromadas
С хромированными шарнирами

Art. 8609/B
MOAI SEAT COVER

Sedile per Wc in termoindurente
Seat cover Wc in termosetting resin
Abattant wc en matière thermodurcissable
WC-deckel Duroplas
Asiento para inodoro en material termoenduracido
Сиденье унитаза из термореактивного полимера

WHITE
185,00

Con cerniera rallentata
With soft close system
Charnieres avec frein de chute
Mit sanft abgebremsten scharnieren
Con caída amortiguada
С микролифтом

Art. 10005
FIXING SET

Staffe di montaggio Wc e bidet
Fixing attachments for Wc and bidet
Supports de montage pour cuvette et bidets suspendus
Montagebügel Für Hänge-wc und bidet
Soportes de montaje inodoro y bidé
Монтажные кронштейны для унитаза и биде

--
70,00

Art. 8610

MOAI 55R - 55 x 45 Cm - 15 Kg - 5 L.**Lavabo da appoggio**

Lay-on washbasin

Lavabo à poser

Aufsatzwaschbecken

Lavabo de apoyo

Раковина умывальника накладная

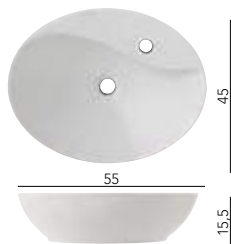
WHITE**315,00****Senza troppo pieno - Consigliata piletta Art. 10034**

Without overflow - Waste Art. 10034 recommended

Sans trop-plein - Bonde Art. 10034 conseillée

Ohne überlauf - Abfluss Art. 10034 empfohlen

Sin rebosadero - Recomendado desagüe Art. 10034

Без пробки перелива - Рекомендуется донный клапан арт. 10034

PALLET QUANTITY - 100x120x200h: 50

PALLET QUANTITY - 80x120x200h: 28

BIOKER + 115,00

Art. 8601

MOAI 71 - 71 x 46 Cm - 15 Kg - 3,5 L.**Lavabo da appoggio**

Lay-on washbasin

Lavabo à poser

Aufsatzwaschbecken

Lavabo de apoyo

Раковина умывальника накладная

WHITE**380,00****Senza troppo pieno - Consigliata piletta Art. 10034**

Without overflow - Waste Art. 10034 recommended

Sans trop-plein - Bonde Art. 10034 conseillée

Ohne überlauf - Abfluss Art. 10034 empfohlen

Sin rebosadero - Recomendado desagüe Art. 10034

Без пробки перелива - Рекомендуется донный клапан арт. 10034

PALLET QUANTITY - 100x120x200h: 20

PALLET QUANTITY - 80x120x200h: 15

BIOKER + 115,00

Art. 8602

MOAI 71R - 71 x 46 Cm - 15 Kg - 3,5 L.**Lavabo da appoggio**

Lay-on washbasin

Lavabo à poser

Aufsatzwaschbecken

Lavabo de apoyo

Раковина умывальника накладная

WHITE**395,00****Senza troppo pieno - Consigliata piletta Art. 10034**

Without overflow - Waste Art. 10034 recommended

Sans trop-plein - Bonde Art. 10034 conseillée

Ohne überlauf - Abfluss Art. 10034 empfohlen

Sin rebosadero - Recomendado desagüe Art. 10034

Без пробки перелива - Рекомендуется донный клапан арт. 10034

PALLET QUANTITY - 100x120x200h: 20

PALLET QUANTITY - 80x120x200h: 15

BIOKER + 115,00

Art. 8603

MOAI FLOOR-STANDING - 51 x 42,5 x 85 Cm - 45 Kg - 7 L.

Lavabo a terra da appoggio

Floor-standing washbasin

Lavabo au sol

Standwaschbecken

Lavabo al suelo de apoyo

Раковина умывальника напольная

WHITE

1.950,00



85



42,5

51

Senza troppo pieno - Sifone e raccordo in plastica incluso

Without overflow - Plastic trap and fitting included

Sans trop-plein - Siphon et raccord en plastique inclus

Ohne überlauf - Siphon und anschluss aus kunststoff mitgeliefert

Sin rebosadero - Sifón y unión in plástico incluyendo

Без пробки перелива - Пластиковые сифон и патрубков входят в комплект

PALLET QUANTITY - 100x120x200h: 6

PALLET QUANTITY - 80x120x200h: 3

BIOKER + 115,00

Art. 10034

Piletta lavabo da 1"1/4

con troppo pieno integrato

1"1/4 washbasin waste with overflow

Bonde lavabo de 1"1/4 avec trop-plein intégré

Waschbeckenabfluss 1"1/4 mit integriertem Überlaufschutz

Desagüe lavabo de 1"1/4 con rebosadero integrado

Донный клапан для умывальника 1"1/4 с интегрированным переливом

CR ●

200,00

NROP ●

220,00

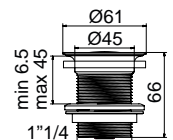

Art. 10010/C

Scarico automatico 1"1/4 click-clack, tappo grande

Automatic pop-waste 1" 1/4 click-clack, big plug

Bonde clic-clac, grand debit

Automatischer ablauf click-clack, crosser stöpsel

Valvula automática 1" 1/4 click-clack, tapón grande

Слив автоматический: клапан 1"1/4, большая пробка

CR ● / NROP ● + WHITE **105,00**

ORS ● + WHITE

145,00



VEIL

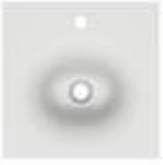

VEIL 46
Art. 6101



VEIL 60
Art. 6102

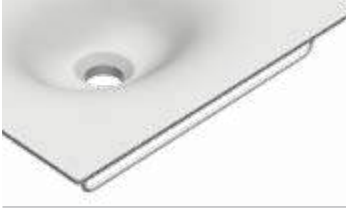

TOWEL BAR



WC BIDET ABBINABILI

MATCHING WCS AND BIDETS - WC ET BIDET COMBINABLES
KOMBINIERBARE WCS UND BIDETS - WC BIDÉ COMBINABLES
УНИТАЗЫ БИДЕ КОМБИНИРУЕМЫЕ



P_8

Art. 5520/CL - 50,5 x 36 - CLEAN FLUSH
Art. 5521 - 50,5 x 36



P_11

Art. 5524/CL - 45 x 35 - CLEAN FLUSH
Art. 5525 - 45 x 35



P_9

Art. 5522 - 54,5 x 36
Art. 5522/CL - 54,5 x 36 - CLEAN FLUSH
Art. 5523 - 54,5 x 36



P_10

Art. 5526/CL - 66 x 36 - CLEAN FLUSH
Art. 5527 - 36 x 15 - CISTERN

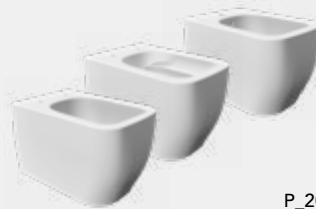

P_20

Art. 5126/TW - 52 x 36 - TWIST
Art. 5126/CL - 52 x 36 - CLEAN FLUSH
Art. 5127 - 52 x 36



P_21

Art. 5138/CL - 55 x 36 - CLEAN FLUSH
Art. 5139 - 55 x 36



P_22

Art. 5140/CL - 66 x 36 - CLEAN FLUSH
Art. 5141 - 35 x 15 - CISTERN



P_48

Art. 5201/TW - 50,5 x 36 - TWIST
Art. 5202 - 50,5 x 36



P_126

Art. 8701 - 50 x 35
Art. 8702 - 50 x 35



P_58

Art. 8812 - 53,5 x 36
Art. 8812/CL - 53,5 x 36 - CLEAN FLUSH
Art. 8813 - 53,5 x 36
Art. 8815 - 40 x 29 - KIDS WC

Art. 6101

VEIL 46 - 46 x 46 Cm - 9 Kg - 2,5 L.

- MODELLO REGISTRATO -
- REGISTERED MODEL -



Lavabo sospeso
Wall-mounted washbasin
Lavabo suspendu
Hängewaschbecken
Lavabo suspendido
Раковина умывальника подвесная

WHITE 500,00

COLORS 700,00

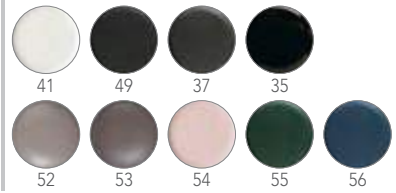

#

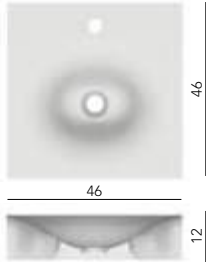

Fissaggi a muro compresi - Senza troppo pieno - Consigliata piletta Art. 10034
Wall attachments included - Without overflow - Waste Art. 10034 recommended
Fixations murales incluses - Sans trop-plein - Bonde Art. 10034 conseillée
Wandbefestigungen inklusive - Ohne überlauf - Abfluss Art. 10034 empfohlen
Fijación pared incluida - Sin rebosadero - Recomendado desagüe Art. 10034
Настенные крепления входят в комплект - Без пробки перелива - Рекомендуется донный клапан арт. 10034

PALLET QUANTITY - 100x120x200h: 50

PALLET QUANTITY - 80x120x200h: 28

BIOKER + 115,00

Art. 6102

VEIL 60 - 60,5 x 46 Cm - 11 Kg - 3,5 L.

- MODELLO REGISTRATO -
- REGISTERED MODEL -



Lavabo sospeso
Wall-mounted washbasin
Lavabo suspendu
Hängewaschbecken
Lavabo suspendido
Раковина умывальника подвесная

WHITE 725,00

COLORS 930,00

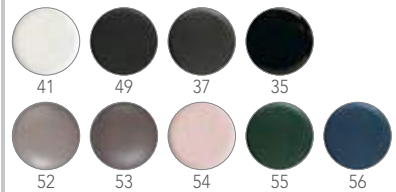

#

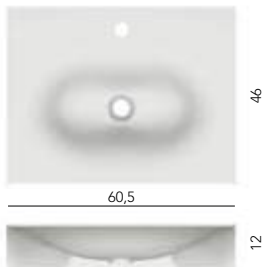

Fissaggi a muro compresi - Senza troppo pieno - Consigliata piletta Art. 10034
Wall attachments included - Without overflow - Waste Art. 10034 recommended
Fixations murales incluses - Sans trop-plein - Bonde Art. 10034 conseillée
Wandbefestigungen inklusive - Ohne überlauf - Abfluss Art. 10034 empfohlen
Fijación pared incluida - Sin rebosadero - Recomendado desagüe Art. 10034
Настенные крепления входят в комплект - Без пробки перелива - Рекомендуется донный клапан арт. 10034

PALLET QUANTITY - 100x120x200h: 40

PALLET QUANTITY - 80x120x200h: 28

BIOKER + 115,00

TOWEL BAR



Porta asciugamani
Towel bar
Porte-Serviettes
Handtuchhalter
Toallero
Держатель полотенец

Art. 6103

Per - For - Pour - Für - Para - Для: Art.: 6101

CR	190,00
BS / NROP	220,00

Art. 6104

Per - For - Pour - Für - Para - Для: Art.: 6102

CR	235,00
BS / NROP	260,00

Art. 10034



Piletta lavabo da 1"1/4
con troppo pieno integrato
1"1/4 washbasin waste with overflow
Bonde lavabo de 1"1/4 avec trop-plein intégré
Waschbeckenabfluss 1"1/4 mit integriertem Überlaufschutz
Desagüe lavabo de 1"1/4 con rebosadero integrado
Донный клапан для умывальника 1"1/4 с интегрированным переливом

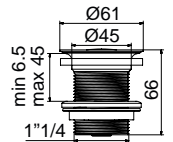

CR	200,00
NROP	220,00

Art. 10010/C



Scarico automatico 1"1/4 click-clack, tappo grande
Automatic pop-waste 1" 1/4 click-clack, big plug
Bonde clic-clac, grand debit
Automatischer ablauf click-clack, crosser stöpsel
Valvula automática 1" 1/4 click-clack, tapón grande
Слив автоматический: клапан 1"1/4, большая пробка

CR / NROP + WHITE 105,00

ORS + WHITE 145,00

CR / NROP + COLORS 130,00

ORS + COLORS 175,00

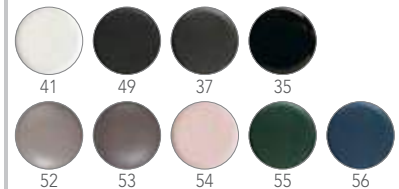



FUJI 50AR
Art. 6013



FUJI 80AR SHELF DX
Art. 6014



FUJI 80AR SHELF SX
Art. 6015



FUJI 50
Art. 6001



FUJI 70
Art. 6002



FUJI 50R
Art. 6003



FUJI 70R
Art. 6004



FUJI ACCESSORIES



German
Design Award



A'DESIGN AWARD



WC BIDET ABBINABILI

MATCHING WCS AND BIDETS - WC ET BIDET COMBINABLES
 KOMBINIERBARE WCS UND BIDETS - WC BIDÉ COMBINABLES
 УНИТАЗЫ БИДЕ КОМБИНИРУЕМЫЕ



P_8

Art. 5520/CL - 50,5 x 36 - CLEAN FLUSH
 Art. 5521 - 50,5 x 36



P_11

Art. 5524/CL - 45 x 35 - CLEAN FLUSH
 Art. 5525 - 45 x 35



P_9

Art. 5522 - 54,5 x 36
 Art. 5522/CL - 54,5 x 36 - CLEAN FLUSH
 Art. 5523 - 54,5 x 36



P_10

Art. 5526/CL - 66 x 36 - CLEAN FLUSH
 Art. 5527 - 36 x 15 - CISTERN



P_76

Art. 8604 - 55 x 41
 Art. 8605 - 55 x 41



P_76/77

Art. 8606 - 55 x 41
 Art. 8607 - 55 x 41



P_68

Art. 8105 - 50 x 45
 Art. 8105/CL - 50 x 45 - CLEAN FLUSH
 Art. 8106 - 50 x 45



P_69

Art. 8401 - 50 x 45
 Art. 8403 - 50 x 45



P_69

Art. 8404 - 38 x 14,5 x h95,5

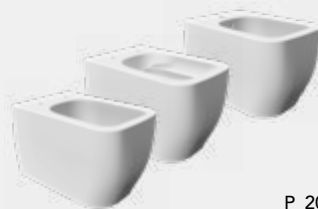

P_20

Art. 5126/TW - 52 x 36 - TWIST
 Art. 5126/CL - 52 x 36 - CLEAN FLUSH
 Art. 5127 - 52 x 36



P_21

Art. 5138/CL - 55 x 36 - CLEAN FLUSH
 Art. 5139 - 55 x 36



P_22

Art. 5140/CL - 66 x 36 - CLEAN FLUSH
 Art. 5141 - 35 x 15 - CISTERN



P_48

Art. 5201/TW - 50,5 x 36 - TWIST
 Art. 5202 - 50,5 x 36



P_126

Art. 8701 - 50 x 35
 Art. 8702 - 50 x 35



P_58

Art. 8812 - 53,5 x 36
 Art. 8812/CL - 53,5 x 36 - CLEAN FLUSH
 Art. 8813 - 53,5 x 36
 Art. 8815 - 40 x 29 - KIDS WC

Art. 6001

FUJI 50 - 50 x 43,5 Cm - 13 Kg - 3 L.



WHITE

390,00

Lavabo da appoggio o sospeso

Lay-on or wall-mounted washbasin

Lavabo à poser ou suspendu

Aufsatz-oder Hängewaschbecken

Lavabo de apoyo o suspendido

Раковина умывальника накладная или подвесная

#



50

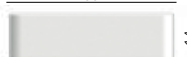

14

Fissaggi a muro compresi - Senza troppo pieno - Consigliata piletta Art. 10034

Wall attachments included - Without overflow - Waste Art. 10034 recommended

Fixations murales incluses - Sans trop-plein - Bonde Art. 10034 conseillée

Wandbefestigungen inklusive - Ohne überlauf - Abfluss Art. 10034 empfohlen

Fijación pared incluida - Sin rebosadero - Recomendado desagüe Art. 10034

Настенные крепления входят в комплект - Без пробки перелива - Рекомендуется донный клапан арт. 10034

PALLET QUANTITY - 100x120x200h: 50

PALLET QUANTITY - 80x120x200h: 28

BIOKER + 115,00

Art. 6002

FUJI 70 - 71 x 43 Cm - 16 Kg - 4,2 L.



WHITE

525,00

Lavabo da appoggio o sospeso

Lay-on or wall-mounted washbasin

Lavabo à poser ou suspendu

Aufsatz-oder Hängewaschbecken

Lavabo de apoyo o suspendido

Раковина умывальника накладная или подвесная

#



71



14

Fissaggi a muro compresi - Senza troppo pieno - Consigliata piletta Art. 10034

Wall attachments included - Without overflow - Waste Art. 10034 recommended

Fixations murales incluses - Sans trop-plein - Bonde Art. 10034 conseillée

Wandbefestigungen inklusive - Ohne überlauf - Abfluss Art. 10034 empfohlen

Fijación pared incluida - Sin rebosadero - Recomendado desagüe Art. 10034

Настенные крепления входят в комплект - Без пробки перелива - Рекомендуется донный клапан арт. 10034

PALLET QUANTITY - 100x120x200h: 30

PALLET QUANTITY - 80x120x200h: 28

BIOKER + 115,00

Art. 6003

FUJI 50R - 50 x 43,5 Cm - 13 Kg - 2,5 L.



WHITE

390,00

Lavabo da appoggio o sospeso

Lay-on or wall-mounted washbasin

Lavabo à poser ou suspendu

Aufsatz-oder Hängewaschbecken

Lavabo de apoyo o suspendido

Раковина умывальника накладная или подвесная

#



50

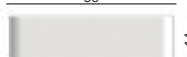

14

Fissaggi a muro compresi - Senza troppo pieno - Consigliata piletta Art. 10034

Wall attachments included - Without overflow - Waste Art. 10034 recommended

Fixations murales incluses - Sans trop-plein - Bonde Art. 10034 conseillée

Wandbefestigungen inklusive - Ohne überlauf - Abfluss Art. 10034 empfohlen

Fijación pared incluida - Sin rebosadero - Recomendado desagüe Art. 10034

Настенные крепления входят в комплект - Без пробки перелива - Рекомендуется донный клапан арт. 10034

PALLET QUANTITY - 100x120x200h: 50

PALLET QUANTITY - 80x120x200h: 28

BIOKER + 115,00

Art. 6004

FUJI 70R - 70 x 43 Cm - 16 Kg - 3,8 L.

WHITE

525,00



Lavabo da appoggio o sospeso

Lay-on or wall-mounted washbasin

Lavabo à poser ou suspendu

Aufsatz-oder Hängewaschbecken

Lavabo de apoyo o suspendido

Раковина умывальника накладная или подвесная

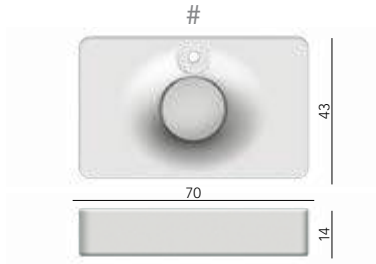

Fissaggi a muro compresi - Senza troppo pieno - Consigliata piletta Art. 10034

Wall attachments included - Without overflow - Waste Art. 10034 recommended

Fixations murales incluses - Sans trop-plein - Bonde Art. 10034 conseillée

Wandbefestigungen inklusive - Ohne überlauf - Abfluss Art. 10034 empfohlen

Fijación pared incluida - Sin rebosadero - Recomendado desagüe Art. 10034

Настенные крепления входят в комплект - Без пробки перелива - Рекомендуется донный клапан арт. 10034

PALLET QUANTITY - 100x120x200h: 30

PALLET QUANTITY - 80x120x200h: 28

BIOKER + 115,00

Art. 6013

FUJI 50AR - 50 x 44 Cm - 13 Kg - 2,8 L.

WHITE

435,00



Lavabo da incasso

Built-in washbasin

Lavabo encastré

Einbauwaschbecken

Lavabo de encaje

Раковина умывальника встраиваемая

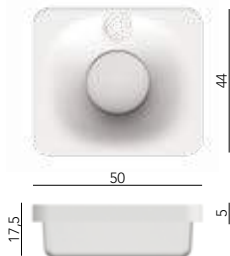

Senza troppo pieno - Consigliata piletta Art. 10034

Without overflow - Waste Art. 10034 recommended

Sans trop-plein - Bonde Art. 10034 conseillée

Ohne überlauf - Abfluss Art. 10034 empfohlen

Sin rebosadero - Recomendado desagüe Art. 10034

Без пробки перелива - Рекомендуется донный клапан арт. 10034

PALLET QUANTITY - 100x120x200h: 50

PALLET QUANTITY - 80x120x200h: 28

BIOKER + 115,00

Art. 6014

FUJI 80AR SHELF DX - 80 x 44 Cm - 18 Kg - 4 L.

WHITE

545,00



Lavabo da incasso

Built-in washbasin

Lavabo encastré

Einbauwaschbecken

Lavabo de encaje

Раковина умывальника встраиваемая



Senza troppo pieno - Consigliata piletta Art. 10034

Without overflow - Waste Art. 10034 recommended

Sans trop-plein - Bonde Art. 10034 conseillée

Ohne überlauf - Abfluss Art. 10034 empfohlen

Sin rebosadero - Recomendado desagüe Art. 10034

Без пробки перелива - Рекомендуется донный клапан арт. 10034

PALLET QUANTITY - 100x120x200h: 16

PALLET QUANTITY - 80x120x200h: 10

BIOKER + 115,00

Art. 6015

FUJI 80AR SHELF SX - 80 x 44 Cm - 18 Kg - 4 L.



Lavabo da incasso
Built-in washbasin
Lavabo encastré
Einbauwaschbecken
Lavabo de encaje
Раковина умывальника встраиваемая

WHITE

545,00



Senza troppo pieno - Consigliata piletta Art. 10034
Without overflow - Waste Art. 10034 recommended
Sans trop-plein - Bonde Art. 10034 conseillée
Ohne überlauf - Abfluss Art. 10034 empfohlen
Sin rebosadero - Recomendado desagüe Art. 10034
Без пробки перелива - Рекомендуется донный клапан арт. 10034

PALLET QUANTITY - 100x120x200h: 16

PALLET QUANTITY - 80x120x200h: 10

BIOKER + 115,00

Art. 10034



Piletta lavabo da 1"1/4
con troppo pieno integrato
1"1/4 washbasin waste with overflow
Bonde lavabo de 1"1/4 avec trop-plein intégré
Waschbeckenabfluss 1"1/4 mit integriertem Überlaufschutz
Desagüe lavabo de 1"1/4 con rebosadero integrado
Донный клапан для умывальника 1"1/4 с интегрированным переливом

CR 

200,00

NROP 

220,00

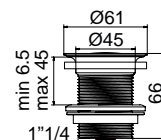

Art. 10010/C



Scarico automatico 1"1/4 click-clack, tappo grande
Automatic pop-waste 1" 1/4 click-clack, big plug
Bonde clic-clac, grand debit
Automatischer ablauf click-clack, crosser stöpsel
Valvula automática 1" 1/4 click-clack, tapón grande
Слив автоматический: клапан 1"1/4, большая пробка

CR  / NROP  + WHITE 105,00ORS  + WHITE

145,00

Art. 6020



Copri piletta in ceramica (ricambio)
Ceramic Cover for pop-up waste (spare)
Cache bonde en céramique (pièce détachée)
Keramische abdeckung für ablauf click-clack (ersatzteil)
Tapa de desagüe de cerámica (repuesto)
Донный клапан из керамики(запасной)

WHITE

70,00

Art. 6005

CONSOLE - L59 P44 H75 Cm



Consolle per lavabo Fuji
 Console for Fuji washbasin
 Console pour lavabo Fuji
 Konsole für waschbecken
 Consolle para lavabo Fuji
 Подставка под раковину умывальника Fuji

Per - For - Pour - Für - Para - Для: 6001 / 6003

PALLET QUANTITY - 100x120x200h: 10+RIPIANI
 PALLET QUANTITY - 80x120x200h: 8+RIPIANI

COLORS

570,00



Art. 6006

CONSOLE - L79 P44 H75 Cm



Consolle per lavabo Fuji
 Console for Fuji washbasin
 Console pour lavabo Fuji
 Konsole für waschbecken
 Consolle para lavabo Fuji
 Подставка под раковину умывальника Fuji

Per - For - Pour - Für - Para - Для: 6002 / 6004

PALLET QUANTITY - 100x120x200h: 7+RIPIANI
 PALLET QUANTITY - 80x120x200h: 4+RIPIANI

COLORS

600,00



Art. 6007

TOWEL RACK - L50 P51 Cm



Porta asciugamano Fuji per lavabo
 Fuji towel rack for washbasin
 Porte-Serviettes Fuji pour lavabo
 Handtuchhalter Fuji für waschbecken
 Toallero Fuji para lavabo
 Держатель полотенца Fuji для раковины умывальника

Per - For - Pour - Für - Para - Для: 6001 / 6003

PALLET QUANTITY - 100x120x200h: 200
 PALLET QUANTITY - 80x120x200h: 140

COLORS

200,00



Art. 6008

TOWEL RACK - L70 P51 Cm



Porta asciugamano Fuji per lavabo
 Fuji towel rack for washbasin
 Porte-Serviettes Fuji pour lavabo
 Handtuchhalter Fuji für waschbecken
 Toallero Fuji para lavabo
 Держатель полотенца Fuji для раковины умывальника

Per - For - Pour - Für - Para - Для: 6002 / 6004

PALLET QUANTITY - 100x120x200h: 200
 PALLET QUANTITY - 80x120x200h: 140

COLORS

210,00

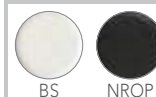

Art. 6011

WOODEN SHELF - L43 P37 H1 Cm

Ripiano in legno per consolle Fuji
 Wooden shelf for Fuji console
 Plan en bois pour consolle Fuji
 Einlegefach aus Holz für Konsole Fuji
 Estantería en madera para consolle Fuji
 Деревянная полка для подставки Fuji

--

200,00

Per - For - Pour - Für - Para - Для: 6005

Art. 6012

WOODEN SHELF - L63 P37 H1 Cm

Ripiano in legno per consolle Fuji
 Wooden shelf for Fuji console
 Plan en bois pour consolle Fuji
 Einlegefach aus Holz für Konsole Fuji
 Estantería en madera para consolle Fuji
 Деревянная полка для подставки Fuji

--

200,00

Per - For - Pour - Für - Para - Для: 6006

Art. 6009

MIRROR - Ø50 Cm

Specchio tondo Fuji
 Fuji round mirror
 Miroir rond Fuji
 Runder Spiegel Fuji
 Espejo redondo Fuji
 Зеркало круглое Fuji

--

280,00

PALLET QUANTITY - 100x120x200h: 96

PALLET QUANTITY - 80x120x200h: 60

Art. 6010

MIRROR - 80 x 70 Cm

Specchio rettangolare Fuji
 Fuji rectangular mirror
 Miroir rectangulaire Fuji
 Rechteckiger Spiegel Fuji
 Espejo rectangular Fuji
 Зеркало прямоугольное Fuji

--

320,00

PALLET QUANTITY - 100x120x200h: 44

PALLET QUANTITY - 80x120x200h: 30



MIZU 45 + COVER
Art. 9001



MIZU 45A + COVER
Art. 9002



MIZU 70 + COVER
Art. 9003



MIZU 70A + COVER
Art. 9004



MIZU 45
Art. 9005



MIZU 45A
Art. 9006



MIZU 70
Art. 9007



MIZU 70A
Art. 9008

DESIGN PLUS



German
Design Award



中国好设计
China Good Design

WC BIDET ABBINABILI

MATCHING WCS AND BIDETS - WC ET BIDET COMBINABLES
KOMBINIERBARE WCS UND BIDETS - WC BIDÉ COMBINABLES
УНИТАЗЫ БИДЕ КОМБИНИРУЕМЫЕ



P_8

Art. 5520/CL - 50,5 x 36 - CLEAN FLUSH
Art. 5521 - 50,5 x 36



P_11

Art. 5524/CL - 45 x 35 - CLEAN FLUSH
Art. 5525 - 45 x 35



P_9

Art. 5522 - 54,5 x 36
Art. 5522/CL - 54,5 x 36 - CLEAN FLUSH
Art. 5523 - 54,5 x 36



P_10

Art. 5526/CL - 66 x 36 - CLEAN FLUSH
Art. 5527 - 36 x 15 - CISTERN

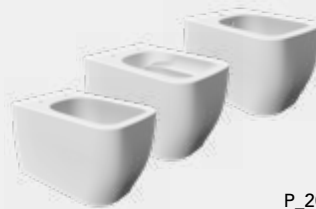

P_20

Art. 5126/TW - 52 x 36 - TWIST
Art. 5126/CL - 52 x 36 - CLEAN FLUSH
Art. 5127 - 52 x 36



P_21

Art. 5138/CL - 55 x 36 - CLEAN FLUSH
Art. 5139 - 55 x 36



P_22

Art. 5140/CL - 66 x 36 - CLEAN FLUSH
Art. 5141 - 35 x 15 - CISTERN



P_48

Art. 5201/TW - 50,5 x 36 - TWIST
Art. 5202 - 50,5 x 36



P_126

Art. 8701 - 50 x 35
Art. 8702 - 50 x 35



P_58

Art. 8812 - 53,5 x 36
Art. 8812/CL - 53,5 x 36 - CLEAN FLUSH
Art. 8813 - 53,5 x 36
Art. 8815 - 40 x 29 - KIDS WC

Art. 9001

- MODELLO REGISTRATO -
- REGISTERED MODEL -

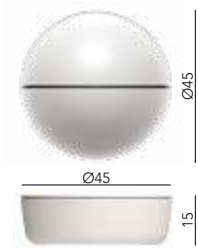

MIZU 45 + COVER - Ø45 Cm - 18 Kg - 9,5 L.

Lavabo da appoggio
Lay-on washbasin
Lavabo à poser
Aufsatzwaschbecken
Lavabo de apoyo
Раковина умывальника накладная

WHITE

670,00

Senza troppo pieno - Consigliata piletta Art. 10034
Without overflow - Waste Art. 10034 recommended
Sans trop-plein - Bonde Art. 10034 conseillée
Ohne überlauf - Abfluss Art. 10034 empfohlen
Sin rebosadero - Recomendado desagüe Art. 10034
Без пробки перелива - Рекомендуется донный клапан арт. 10034

PALLET QUANTITY - 100x120x200h: 24
PALLET QUANTITY - 80x120x200h: 16

BIOKER + 115,00

Art. 9003

- MODELLO REGISTRATO -
- REGISTERED MODEL -

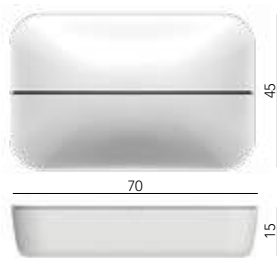

MIZU 70 + COVER - 70 x 45 Cm - 20 Kg - 16,5 L.

Lavabo da appoggio
Lay-on washbasin
Lavabo à poser
Aufsatzwaschbecken
Lavabo de apoyo
Раковина умывальника накладная

WHITE

910,00

Senza troppo pieno - Consigliata piletta Art. 10034
Without overflow - Waste Art. 10034 recommended
Sans trop-plein - Bonde Art. 10034 conseillée
Ohne überlauf - Abfluss Art. 10034 empfohlen
Sin rebosadero - Recomendado desagüe Art. 10034
Без пробки перелива - Рекомендуется донный клапан арт. 10034

PALLET QUANTITY - 100x120x200h: 16
PALLET QUANTITY - 80x120x200h: 16

BIOKER + 115,00

Art. 9005



MIZU 45 - Ø45 Cm - 9 Kg - 13 L.

Lavabo da appoggio
Lay-on washbasin
Lavabo à poser
Aufsatzwaschbecken
Lavabo de apoyo
Раковина умывальника накладная

WHITE

335,00

Senza troppo pieno - Consigliata piletta Art. 10034
Without overflow - Waste Art. 10034 recommended
Sans trop-plein - Bonde Art. 10034 conseillée
Ohne überlauf - Abfluss Art. 10034 empfohlen
Sin rebosadero - Recomendado desagüe Art. 10034
Без пробки перелива - Рекомендуется донный клапан арт. 10034

PALLET QUANTITY - 100x120x200h: 50
PALLET QUANTITY - 80x120x200h: 28

BIOKER + 115,00

Art. 9007

MIZU 70 - 70 x 45 Cm - 10 Kg - 25 L.

WHITE

450,00



Lavabo da appoggio

Lay-on washbasin

Lavabo à poser

Aufsatzwaschbecken

Lavabo de apoyo

Раковина умывальника накладная

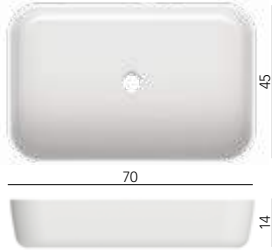

Senza troppo pieno - Consigliata piletta Art. 10034

Without overflow - Waste Art. 10034 recommended

Sans trop-plein - Bonde Art. 10034 conseillée

Ohne überlauf - Abfluss Art. 10034 empfohlen

Sin rebosadero - Recomendado desagüe Art. 10034

Без пробки перелива - Рекомендуется донный клапан арт. 10034

PALLET QUANTITY - 100x120x200h: 30

PALLET QUANTITY - 80x120x200h: 28

BIOKER + 115,00

Art. 9002

MIZU 45A + COVER - Ø45 Cm - 18 Kg - 9,5 L.

WHITE

715,00

- MODELLO REGISTRATO -
- REGISTERED MODEL -



Lavabo da incasso

Built-in washbasin

Lavabo encastré

Einbauwaschbecken

Lavabo de encaje

Раковина умывальника встраиваемая

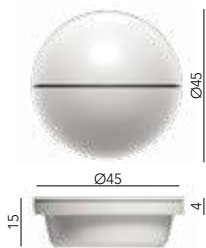

Senza troppo pieno - Consigliata piletta Art. 10034

Without overflow - Waste Art. 10034 recommended

Sans trop-plein - Bonde Art. 10034 conseillée

Ohne überlauf - Abfluss Art. 10034 empfohlen

Sin rebosadero - Recomendado desagüe Art. 10034

Без пробки перелива - Рекомендуется донный клапан арт. 10034

PALLET QUANTITY - 100x120x200h: 24

PALLET QUANTITY - 80x120x200h: 16

BIOKER + 115,00

Art. 9004

MIZU 70A + COVER - 70 x 45 Cm - 20 Kg - 16,5 L.

WHITE

980,00

- MODELLO REGISTRATO -
- REGISTERED MODEL -



Lavabo da incasso

Built-in washbasin

Lavabo encastré

Einbauwaschbecken

Lavabo de encaje

Раковина умывальника встраиваемая



Senza troppo pieno - Consigliata piletta Art. 10034

Without overflow - Waste Art. 10034 recommended

Sans trop-plein - Bonde Art. 10034 conseillée

Ohne überlauf - Abfluss Art. 10034 empfohlen

Sin rebosadero - Recomendado desagüe Art. 10034

Без пробки перелива - Рекомендуется донный клапан арт. 10034

PALLET QUANTITY - 100x120x200h: 16

PALLET QUANTITY - 80x120x200h: 16

BIOKER + 115,00

Art. 9006

MIZU 45A - Ø45 Cm - 9 Kg - 13 L.



Lavabo da incasso
Built-in washbasin
Lavabo encastré
Einbauwaschbecken
Lavabo de encaje
Раковина умывальника встраиваемая

WHITE

380,00

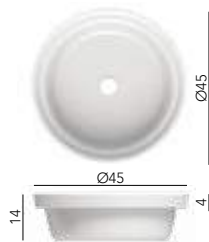

Senza troppo pieno - Consigliata piletta Art. 10034
Without overflow - Waste Art. 10034 recommended
Sans trop-plein - Bonde Art. 10034 conseillée
Ohne überlauf - Abfluss Art. 10034 empfohlen
Sin rebosadero - Recomendado desagüe Art. 10034
Без пробки перелива - Рекомендуется донный клапан арт. 10034

PALLET QUANTITY - 100x120x200h: 50

PALLET QUANTITY - 80x120x200h: 28

BIOKER + 115,00

Art. 9008

MIZU 70A - 70 x 45 Cm - 10 Kg - 25 L.



Lavabo da incasso
Built-in washbasin
Lavabo encastré
Einbauwaschbecken
Lavabo de encaje
Раковина умывальника встраиваемая

WHITE

520,00

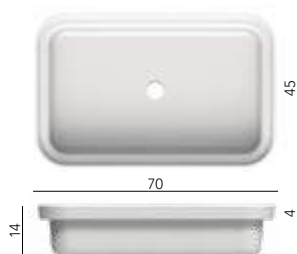

Senza troppo pieno - Consigliata piletta Art. 10034
Without overflow - Waste Art. 10034 recommended
Sans trop-plein - Bonde Art. 10034 conseillée
Ohne überlauf - Abfluss Art. 10034 empfohlen
Sin rebosadero - Recomendado desagüe Art. 10034
Без пробки перелива - Рекомендуется донный клапан арт. 10034

PALLET QUANTITY - 100x120x200h: 30

PALLET QUANTITY - 80x120x200h: 28

BIOKER + 115,00

Art. 10034



Piletta lavabo da 1"1/4
con troppo pieno integrato
1"1/4 washbasin waste with overflow
Bonde lavabo de 1"1/4 avec trop-plein intégré
Waschbeckenabfluss 1"1/4 mit integriertem Überlaufschutz
Desagüe lavabo de 1"1/4 con rebosadero integrado
Донный клапан для умывальника 1"1/4 с интегрированным переливом

CR ●

200,00

NROP ●

220,00

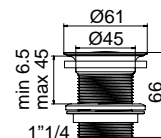

Art. 10010/C



Scarico automatico 1"1/4 click-clack, tappo grande
Automatic pop-waste 1" 1/4 click-clack, big plug
Bonde clic-clac, grand debit
Automatischer ablauf click-clack, crosser stöpsel
Valvula automática 1" 1/4 click-clack, tapón grande
Слив автоматический: клапан 1"1/4, большая пробка

CR ● / NROP ● + WHITE

105,00

ORS ● + WHITE

145,00

Art. 9009

COVER 45 - 9 Kg



Coppia cover per Mizu 45

Couple or covers for Mizu 45

Paire capots pour Mizu 45

Coverpaar für Mizu 45

Par de tapas para Mizu 45

Пара крышек для Mizu 45

WHITE

335,00

PALLET QUANTITY - 100x120x200h: 56

PALLET QUANTITY - 80x120x200h: 42

Art. 9010

COVER 70 - 10 Kg

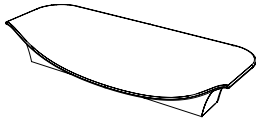

Coppia cover per Mizu 70

Couple or covers for Mizu 70

Paire capots pour Mizu 70

Coverpaar für Mizu 70

Par de tapas para Mizu 70

Пара крышек для Mizu 70

WHITE

460,00

PALLET QUANTITY - 100x120x200h: 35

PALLET QUANTITY - 80x120x200h: 28



SOFT 45
Art. 1501



HUNG 60
Art. 1511



CUBE 24 H24
Art. 1521



SOFT 38
Art. 1502



HUNG 50
Art. 1512



CUBE 42 H24
Art. 1522



SOFT 30
Art. 1503



HUNG 40
Art. 1513



CUBE 42 H11
Art. 1523



WC BIDET ABBINABILI

MATCHING WCS AND BIDETS - WC ET BIDET COMBINABLES
KOMBINIERBARE WCS UND BIDETS - WC BIDÉ COMBINABLES
УНИТАЗЫ БИДЕ КОМБИНИРУЕМЫЕ



P_8

Art. 5520/CL - 50,5 x 36 - CLEAN FLUSH
Art. 5521 - 50,5 x 36



P_11

Art. 5524/CL - 45 x 35 - CLEAN FLUSH
Art. 5525 - 45 x 35



P_9

Art. 5522 - 54,5 x 36
Art. 5522/CL - 54,5 x 36 - CLEAN FLUSH
Art. 5523 - 54,5 x 36



P_10

Art. 5526/CL - 66 x 36 - CLEAN FLUSH
Art. 5527 - 36 x 15 - CISTERN

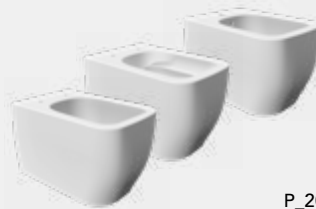

P_20

Art. 5126/TW - 52 x 36 - TWIST
Art. 5126/CL - 52 x 36 - CLEAN FLUSH
Art. 5127 - 52 x 36



P_21

Art. 5138/CL - 55 x 36 - CLEAN FLUSH
Art. 5139 - 55 x 36



P_22

Art. 5140/CL - 66 x 36 - CLEAN FLUSH
Art. 5141 - 35 x 15 - CISTERN



P_48

Art. 5201/TW - 50,5 x 36 - TWIST
Art. 5202 - 50,5 x 36



P_126

Art. 8701 - 50 x 35
Art. 8702 - 50 x 35



P_58

Art. 8812 - 53,5 x 36
Art. 8812/CL - 53,5 x 36 - CLEAN FLUSH
Art. 8813 - 53,5 x 36
Art. 8815 - 40 x 29 - KIDS WC

Art. 1501

SOFT 45 - 45 x 22 Cm - 6 Kg - 1,3 L.



Lavabo da appoggio o sospeso
 Lay-on or wall-mounted washbasin
 Lavabo à poser ou suspendu
 Aufsatz-oder Hängewaschbecken
 Lavabo de apoyo o suspendido
 Раковина умывальника накладная или подвесная

Fissaggi a muro compresi - Senza troppo pieno
 Consigliata piletta Art. 10034 / 10026
 Wall attachments included - Without overflow
 Waste Art. 10034 / 10026 recommended
 Fixations murales incluses - Sans trop-plein
 Bonde Art. 10034 / 10026 conseillée
 Wandbefestigungen inklusive - Ohne überlauf
 Abfluss Art. 10034 / 10026 empfohlen
 Fijación pared incluida - Sin rebosadero
 Recomendado desagüe Art. 10034 / 10026
 Настенные крепления входят в комплект - Без пробки перелива
 Рекомендуется донный клапан арт. 10034 / 10026

PALLET QUANTITY - 100x120x200h: 96
 PALLET QUANTITY - 80x120x200h: 72

BIOKER + 115,00

WHITE 280,00

COLORS 470,00



DecorLAB 495,00

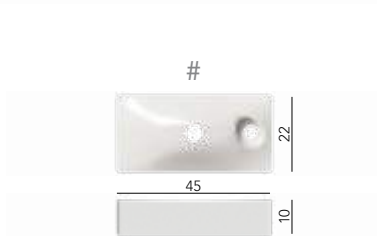
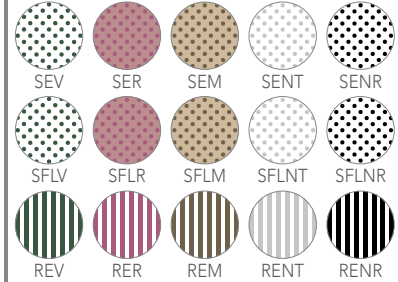

Art. 1502

SOFT 38 - 38 x 22 Cm - 5 Kg - 1,2 L.



Lavabo da appoggio o sospeso
 Lay-on or wall-mounted washbasin
 Lavabo à poser ou suspendu
 Aufsatz-oder Hängewaschbecken
 Lavabo de apoyo o suspendido
 Раковина умывальника накладная или подвесная

Fissaggi a muro compresi - Senza troppo pieno
 Consigliata piletta Art. 10034 / 10026
 Wall attachments included - Without overflow
 Waste Art. 10034 / 10026 recommended
 Fixations murales incluses - Sans trop-plein
 Bonde Art. 10034 / 10026 conseillée
 Wandbefestigungen inklusive - Ohne überlauf
 Abfluss Art. 10034 / 10026 empfohlen
 Fijación pared incluida - Sin rebosadero
 Recomendado desagüe Art. 10034 / 10026
 Настенные крепления входят в комплект - Без пробки перелива
 Рекомендуется донный клапан арт. 10034 / 10026

PALLET QUANTITY - 100x120x200h: 161
 PALLET QUANTITY - 80x120x200h: 110

BIOKER + 115,00

WHITE 235,00

COLORS 430,00



DecorLAB 480,00

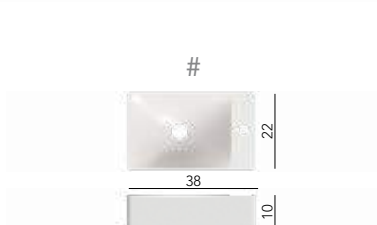

Art. 1503

SOFT 30 - 30 x 22 Cm - 4 Kg - 1,3 L.



Lavabo da appoggio
 Lay-on washbasin
 Lavabo à poser
 Aufsatzwaschbecken
 Lavabo de apoyo
 Раковина умывальника накладная

Senza troppo pieno - Consigliata piletta Art. 10034 / 10026
 Without overflow - Waste Art. 10034 / 10026 recommended
 Sans trop-plein - Bonde Art. 10034 / 10026 conseillée
 Ohne überlauf - Abfluss Art. 10034 / 10026 empfohlen
 Sin rebosadero - Recomendado desagüe Art. 10034 / 10026
 Без пробки перелива - Рекомендуется донный клапан арт. 10034 / 10026

PALLET QUANTITY - 100x120x200h: 225
 PALLET QUANTITY - 80x120x200h: 143

BIOKER + 115,00

WHITE 220,00

COLORS 420,00

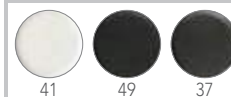

DecorLAB 460,00

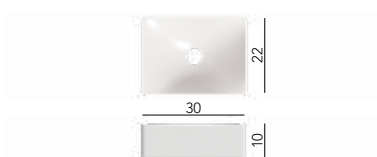

Art. 1511

HUNG 60 - 60 x 22 Cm - 7 Kg - 1 L.

Lavabo sospeso
Wall-mounted washbasin
Lavabo suspendu
Hängewaschbecken
Lavabo suspendido
Раковина умывальника подвесная



Fissaggi a muro compresi - Senza troppo pieno
Consigliata piletta Art. 10034 / 10026
Wall attachments included - Without overflow
Waste Art. 10034 / 10026 recommended
Fixations murales incluses - Sans trop-plein
Bonde Art. 10034 / 10026 conseillée
Wandbefestigungen inklusive - Ohne überlauf
Abfluss Art. 10034 / 10026 empfohlen
Fijación pared incluida - Sin rebosadero
Recomendado desagüe Art. 10034 / 10026
Настенные крепления входят в комплект - Без пробки перелива
Рекомендуется донный клапан арт. 10034 / 10026

PALLET QUANTITY - 100x120x200h: 112
PALLET QUANTITY - 80x120x200h: 84

BIOKER + 115,00

WHITE

325,00

COLORS

549,00



DecorLAB

550,00

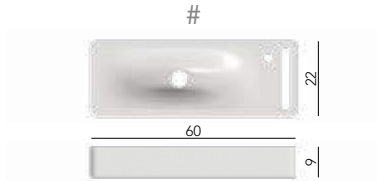
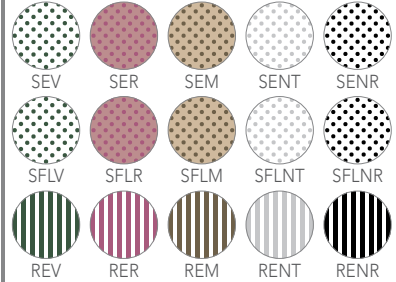

Art. 1512

HUNG 50 - 50 x 22 Cm - 6 Kg - 0,7 L.

Lavabo sospeso
Wall-mounted washbasin
Lavabo suspendu
Hängewaschbecken
Lavabo suspendido
Раковина умывальника подвесная



Fissaggi a muro compresi - Senza troppo pieno
Consigliata piletta Art. 10034 / 10026
Wall attachments included - Without overflow
Waste Art. 10034 / 10026 recommended
Fixations murales incluses - Sans trop-plein
Bonde Art. 10034 / 10026 conseillée
Wandbefestigungen inklusive - Ohne überlauf
Abfluss Art. 10034 / 10026 empfohlen
Fijación pared incluida - Sin rebosadero
Recomendado desagüe Art. 10034 / 10026
Настенные крепления входят в комплект - Без пробки перелива
Рекомендуется донный клапан арт. 10034 / 10026

PALLET QUANTITY - 100x120x200h: 120
PALLET QUANTITY - 80x120x200h: 84

BIOKER + 115,00

WHITE

290,00

COLORS

490,00



DecorLAB

520,00



Art. 1513

HUNG 40 - 40 x 22 Cm - 5 Kg - 0,5 L.

Lavabo sospeso
Wall-mounted washbasin
Lavabo suspendu
Hängewaschbecken
Lavabo suspendido
Раковина умывальника подвесная



Fissaggi a muro compresi - Senza troppo pieno
Consigliata piletta Art. 10034 / 10026
Wall attachments included - Without overflow
Waste Art. 10034 / 10026 recommended
Fixations murales incluses - Sans trop-plein
Bonde Art. 10034 / 10026 conseillée
Wandbefestigungen inklusive - Ohne überlauf
Abfluss Art. 10034 / 10026 empfohlen
Fijación pared incluida - Sin rebosadero
Recomendado desagüe Art. 10034 / 10026
Настенные крепления входят в комплект - Без пробки перелива
Рекомендуется донный клапан арт. 10034 / 10026

PALLET QUANTITY - 100x120x200h: 161
PALLET QUANTITY - 80x120x200h: 110

BIOKER + 115,00

WHITE

215,00

COLORS

420,00

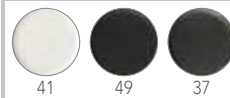

DecorLAB

450,00

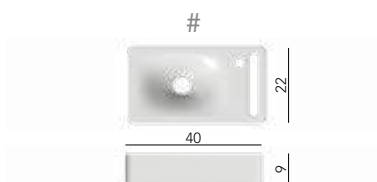
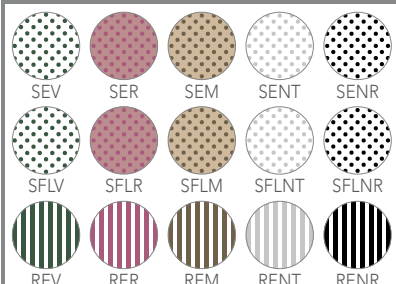

Art. 1521

CUBE 24 H24 - 24 x 24 Cm - 8 Kg - 0,7 L.



Lavabo da appoggio o sospeso

Lay-on or wall-mounted washbasin

Lavabo à poser ou suspendu

Aufsatz-oder Hängewaschbecken

Lavabo de apoyo o suspendido

Раковина умывальника накладная или подвесная

Fissaggi a muro compresi - Senza troppo pieno

Consigliata piletta Art. 10034 / 10026

Wall attachments included - Without overflow

Waste Art. 10034 / 10026 recommended

Fixations murales incluses - Sans trop-plein

Bonde Art. 10034 / 10026 conseillée

Wandbefestigungen inklusive - Ohne überlauf

Abfluss Art. 10034 / 10026 empfohlen

Fijación pared incluida - Sin rebosadero

Recomendado desagüe Art. 10034 / 10026

Настенные крепления входят в комплект - Без пробки перелива

Рекомендуется донный клапан арт. 10034 / 10026

PALLET QUANTITY - 100x120x200h: 96

PALLET QUANTITY - 80x120x200h: 72

BIOKER + 115,00

WHITE

275,00

COLORS

485,00



DecorLAB

510,00



Art. 1522

CUBE 42 H24 - 42 x 24 Cm - 10 Kg - 0,7 L.



Lavabo da appoggio o sospeso

Lay-on or wall-mounted washbasin

Lavabo à poser ou suspendu

Aufsatz-oder Hängewaschbecken

Lavabo de apoyo o suspendido

Раковина умывальника накладная или подвесная

Fissaggi a muro compresi - Senza troppo pieno

Consigliata piletta Art. 10034 / 10026

Wall attachments included - Without overflow

Waste Art. 10034 / 10026 recommended

Fixations murales incluses - Sans trop-plein

Bonde Art. 10034 / 10026 conseillée

Wandbefestigungen inklusive - Ohne überlauf

Abfluss Art. 10034 / 10026 empfohlen

Fijación pared incluida - Sin rebosadero

Recomendado desagüe Art. 10034 / 10026

Настенные крепления входят в комплект - Без пробки перелива

Рекомендуется донный клапан арт. 10034 / 10026

PALLET QUANTITY - 100x120x200h: 70

PALLET QUANTITY - 80x120x200h: 44

BIOKER + 115,00

WHITE

320,00

COLORS

535,00



DecorLAB

580,00

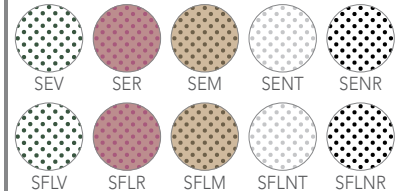

Art. 1523

CUBE 42 H11 - 42 x 24 Cm - 5 Kg - 0,7 L.



Lavabo da appoggio o sospeso

Lay-on or wall-mounted washbasin

Lavabo à poser ou suspendu

Aufsatz-oder Hängewaschbecken

Lavabo de apoyo o suspendido

Раковина умывальника накладная или подвесная

Fissaggi a muro compresi - Senza troppo pieno

Consigliata piletta Art. 10034 / 10026

Wall attachments included - Without overflow

Waste Art. 10034 / 10026 recommended

Fixations murales incluses - Sans trop-plein

Bonde Art. 10034 / 10026 conseillée

Wandbefestigungen inklusive - Ohne überlauf

Abfluss Art. 10034 / 10026 empfohlen

Fijación pared incluida - Sin rebosadero

Recomendado desagüe Art. 10034 / 10026

Настенные крепления входят в комплект - Без пробки перелива

Рекомендуется донный клапан арт. 10034 / 10026

PALLET QUANTITY - 100x120x200h: 126

PALLET QUANTITY - 80x120x200h: 72

BIOKER + 115,00

WHITE

220,00

COLORS

410,00

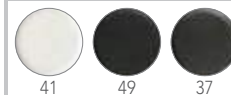

DecorLAB

435,00

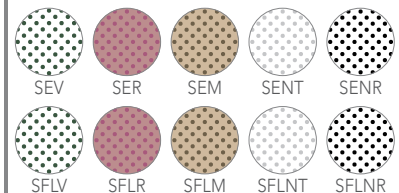

Art. 10034



Piletta lavabo da 1"1/4
con troppo pieno integrato

1"1/4 washbasin waste with overflow

Bonde lavabo de 1"1/4 avec trop-plein intégré

Waschbeckenabfluss 1"1/4 mit integriertem Überlaufschutz

Desagüe lavabo de 1"1/4 con rebosadero integrado

Донный клапан для умывальника 1"1/4 с интегрированным переливом

CR ● 200,00

NROP ● 220,00

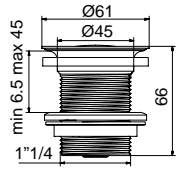

Art. 10026



Piletta sempre aperta

Waste always open

Bonde toujours ouverte

Immer offener Auslauf

Piletta siempre abierta

Сток всегда открыт

CR ● 118,00



KYLIS
Art. 8046



KYLIS R
Art. 8046/R



NECK
Art. 8045



CUP
Art. 8044



SFERA
Art. 8009



SFERA R
Art. 8009/R



CONO
Art. 8010



CONO R
Art. 8010/R



OVO
Art. 8011



GEO
Art. 8029



GEO R
Art. 8029/R



GEO D
Art. 8029/D



WIND
Art. 8030



WIND R
Art. 8030/R

WC BIDET ABBINABILI

MATCHING WCS AND BIDETS - WC ET BIDET COMBINABLES
KOMBINIERBARE WCS UND BIDETS - WC BIDÉ COMBINABLES
УНИТАЗЫ БИДЕ КОМБИНИРУЕМЫЕ



P_8

Art. 5520/CL - 50,5 x 36 - CLEAN FLUSH
Art. 5521 - 50,5 x 36



P_11

Art. 5524/CL - 45 x 35 - CLEAN FLUSH
Art. 5525 - 45 x 35



P_9

Art. 5522 - 54,5 x 36
Art. 5522/CL - 54,5 x 36 - CLEAN FLUSH
Art. 5523 - 54,5 x 36



P_10

Art. 5526/CL - 66 x 36 - CLEAN FLUSH
Art. 5527 - 36 x 15 - CISTERN

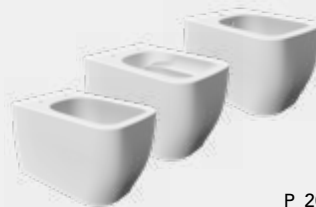

P_20

Art. 5126/TW - 52 x 36 - TWIST
Art. 5126/CL - 52 x 36 - CLEAN FLUSH
Art. 5127 - 52 x 36



P_21

Art. 5138/CL - 55 x 36 - CLEAN FLUSH
Art. 5139 - 55 x 36



P_22

Art. 5140/CL - 66 x 36 - CLEAN FLUSH
Art. 5141 - 35 x 15 - CISTERN



P_48

Art. 5201/TW - 50,5 x 36 - TWIST
Art. 5202 - 50,5 x 36



P_126

Art. 8701 - 50 x 35
Art. 8702 - 50 x 35



P_58

Art. 8812 - 53,5 x 36
Art. 8812/CL - 53,5 x 36 - CLEAN FLUSH
Art. 8813 - 53,5 x 36
Art. 8815 - 40 x 29 - KIDS WC

Art. 8046

KYLIS - 63 x 46 Cm - 15 Kg - 13 L.



Lavabo da appoggio
Lay-on washbasin
Lavabo à poser
Aufsatzwaschbecken
Lavabo de apoyo
Раковина умывальника накладная

WHITE

290,00



Senza troppo pieno - Consigliata piletta Art. 10034
Without overflow - Waste Art. 10034 recommended
Sans trop-plein - Bonde Art. 10034 conseillée
Ohne überlauf - Abfluss Art. 10034 empfohlen
Sin rebosadero - Recomendado desagüe Art. 10034
Без пробки перелива - Рекомендуется донный клапан арт. 10034

PALLET QUANTITY - 100x120x200h: 40

PALLET QUANTITY - 80x120x200h: 28

BIOKER + 115,00

Art. 8046/R

KYLIS R - 62 x 44,5 Cm - 15 Kg - 5 L.



Lavabo da appoggio o sospeso
Lay-on or wall-mounted washbasin
Lavabo à poser ou suspendu
Aufsatz-oder Hängewaschbecken
Lavabo de apoyo o suspendido
Раковина умывальника накладная или подвесная

WHITE

350,00

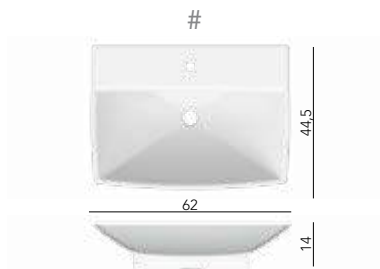

Fissaggi a muro compresi - Borchia troppo pieno compresa
Wall attachments included - Overflow cap included
Fixations murales incluses - Anneau trop-plein inclus
Wandbefestigungen inklusive - Beschlag für Überlaufschutz inklusive
Fijación pared incluida - Tachón rebosadero incluido
Настенные крепления входят в комплект - Перелив входит в комплект

PALLET QUANTITY - 100x120x200h: 40

PALLET QUANTITY - 80x120x200h: 28

BIOKER + 115,00

Art. 8045

NECK - 63 x 45 Cm - 12 Kg - 8,5 L.



Lavabo da appoggio
Lay-on washbasin
Lavabo à poser
Aufsatzwaschbecken
Lavabo de apoyo
Раковина умывальника накладная

WHITE

290,00

COLORS

475,00

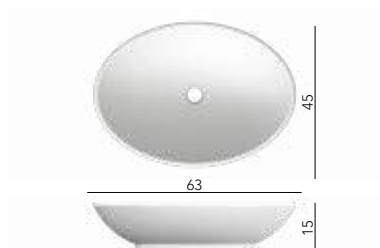
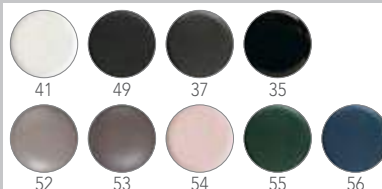

Senza troppo pieno - Consigliata piletta Art. 10034
Without overflow - Waste Art. 10034 recommended
Sans trop-plein - Bonde Art. 10034 conseillée
Ohne überlauf - Abfluss Art. 10034 empfohlen
Sin rebosadero - Recomendado desagüe Art. 10034
Без пробки перелива - Рекомендуется донный клапан арт. 10034

PALLET QUANTITY - 100x120x200h: 34

PALLET QUANTITY - 80x120x200h: 26

BIOKER + 115,00

Art. 8044

CUP - Ø45 Cm - 8 Kg - 4 L.



Lavabo da appoggio
Lay-on washbasin
Lavabo à poser
Aufsatzwaschbecken
Lavabo de apoyo
Раковина умывальника накладная

WHITE

290,00

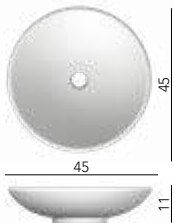

Senza troppo pieno - Consigliata piletta Art. 10034
Without overflow - Waste Art. 10034 recommended
Sans trop-plein - Bonde Art. 10034 conseillée
Ohne überlauf - Abfluss Art. 10034 empfohlen
Sin rebosadero - Recomendado desagüe Art. 10034
Без пробки перелива - Рекомендуется донный клапан арт. 10034

PALLET QUANTITY - 100x120x200h: 50

PALLET QUANTITY - 80x120x200h: 28

BIOKER + 115,00

Art. 8009

SFERA - Ø39,5 Cm - 6 Kg - 5 L.



Lavabo da appoggio
Lay-on washbasin
Lavabo à poser
Aufsatzwaschbecken
Lavabo de apoyo
Раковина умывальника накладная

WHITE

205,00

COLORS

420,00

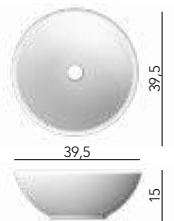
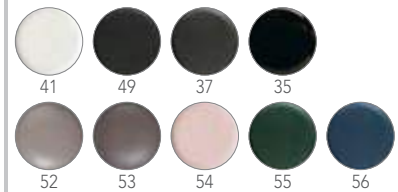

Senza troppo pieno - Consigliata piletta Art. 10034
Without overflow - Waste Art. 10034 recommended
Sans trop-plein - Bonde Art. 10034 conseillée
Ohne überlauf - Abfluss Art. 10034 empfohlen
Sin rebosadero - Recomendado desagüe Art. 10034
Без пробки перелива - Рекомендуется донный клапан арт. 10034

PALLET QUANTITY - 100x120x200h: 50

PALLET QUANTITY - 80x120x200h: 36

BIOKER + 115,00

Art. 8009/R

SFERA R - 40 x 42 Cm - 9 Kg - 4 L.



Lavabo da appoggio o sospeso
Lay-on or wall-mounted washbasin
Lavabo à poser ou suspendu
Aufsatz- oder Hängewaschbecken
Lavabo de apoyo o suspendido
Раковина умывальника накладная или подвесная

WHITE

260,00



Fissaggi a muro compresi - Borchia troppo pieno compresa
Wall attachments included - Overflow cap included
Fixations murales incluses - Anneau trop-plein inclus
Wandbefestigungen inklusive - Beschlag für Überlaufschutz inklusive
Fijación pared incluida - Tachón rebosadero incluido
Настенные крепления входят в комплект - Перелив входит в комплект

PALLET QUANTITY - 100x120x200h: 50

PALLET QUANTITY - 80x120x200h: 36

BIOKER + 115,00

Art. 8010

CONO - Ø42 Cm - 6 Kg - 5 L.



Lavabo da appoggio
Lay-on washbasin
Lavabo à poser
Aufsatzwaschbecken
Lavabo de apoyo
Раковина умывальника накладная

WHITE

210,00

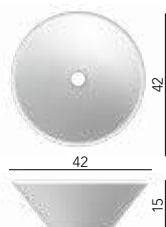

Senza troppo pieno - Consigliata piletta Art. 10034
Without overflow - Waste Art. 10034 recommended
Sans trop-plein - Bonde Art. 10034 conseillée
Ohne überlauf - Abfluss Art. 10034 empfohlen
Sin rebosadero - Recomendado desagüe Art. 10034
Без пробки перелива - Рекомендуется донный клапан арт. 10034

PALLET QUANTITY - 100x120x200h: 50

PALLET QUANTITY - 80x120x200h: 36

BIOKER + 115,00

Art. 8010/R

CONO R - 42 x 43 Cm - 9 Kg - 4 L.



Lavabo da appoggio o sospeso
Lay-on or wall-mounted washbasin
Lavabo à poser ou suspendu
Aufsatz-oder Hängewaschbecken
Lavabo de apoyo o suspendido
Раковина умывальника накладная или подвесная

WHITE

260,00



Fissaggi a muro compresi - Borchia troppo pieno compresa
Wall attachments included - Overflow cap included
Fixations murales incluses - Anneau trop-plein inclus
Wandbefestigungen inklusive - Beschlag für Überlaufschutz inklusive
Fijación pared incluida - Tachón rebosadero incluido
Настенные крепления входят в комплект - Перелив входит в комплект

PALLET QUANTITY - 100x120x200h: 50

PALLET QUANTITY - 80x120x200h: 36

BIOKER + 115,00

Art. 8011

OVO - 41 x 33,5 Cm - 6 Kg - 4 L.



Lavabo da appoggio
Lay-on washbasin
Lavabo à poser
Aufsatzwaschbecken
Lavabo de apoyo
Раковина умывальника накладная

WHITE

205,00

COLORS

420,00

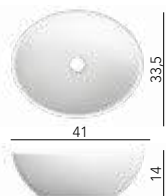
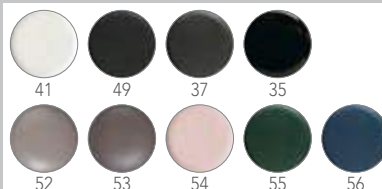

Senza troppo pieno - Consigliata piletta Art. 10034
Without overflow - Waste Art. 10034 recommended
Sans trop-plein - Bonde Art. 10034 conseillée
Ohne überlauf - Abfluss Art. 10034 empfohlen
Sin rebosadero - Recomendado desagüe Art. 10034
Без пробки перелива - Рекомендуется донный клапан арт. 10034

PALLET QUANTITY - 100x120x200h: 50

PALLET QUANTITY - 80x120x200h: 36

BIOKER + 115,00

Art. 8029

GEO - Ø45 Cm - 9 Kg - 3,5 L.

WHITE

270,00



Lavabo da appoggio

Lay-on washbasin

Lavabo à poser

Aufsatzwaschbecken

Lavabo de apoyo

Раковина умывальника накладная

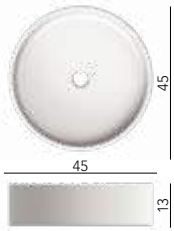

Senza troppo pieno - Consigliata piletta Art. 10034

Without overflow - Waste Art. 10034 recommended

Sans trop-plein - Bonde Art. 10034 conseillée

Ohne überlauf - Abfluss Art. 10034 empfohlen

Sin rebosadero - Recomendado desagüe Art. 10034

Без пробки перелива - Рекомендуется донный клапан арт. 10034

PALLET QUANTITY - 100x120x200h: 50

PALLET QUANTITY - 80x120x200h: 28

BIOKER + 115,00

Art. 8029/R

GEO R - Ø46 Cm - 9 Kg - 3,5 L.

WHITE

270,00



Lavabo da appoggio

Lay-on washbasin

Lavabo à poser

Aufsatzwaschbecken

Lavabo de apoyo

Раковина умывальника накладная

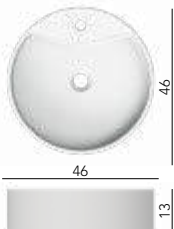

Borchia troppo pieno compresa

Overflow cap included

Anneau trop-plein inclus

Beschlag für Überlaufschutz inklusive

Tachón rebosadero incluido

Перелив входит в комплект

PALLET QUANTITY - 100x120x200h: 50

PALLET QUANTITY - 80x120x200h: 28

BIOKER + 115,00

Art. 8029/D

GEO D - Ø46 Cm - 9 Kg - 3 L.

WHITE

270,00



Lavabo da semincasso

Semi built-in washbasin

Lavabo semi encastré

Vorbauwaschbecken

Lavabo de semiencaje

Раковина умывальника полувстраиваемая

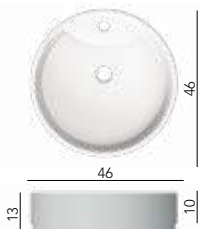

Borchia troppo pieno compresa

Overflow cap included

Anneau trop-plein inclus

Beschlag für Überlaufschutz inklusive

Tachón rebosadero incluido

Перелив входит в комплект

PALLET QUANTITY - 100x120x200h: 50

PALLET QUANTITY - 80x120x200h: 28

BIOKER + 115,00

Art. 8030

WIND - 54,5 x 45 Cm - 11 Kg - 3,5 L.



Lavabo da appoggio
Lay-on washbasin
Lavabo à poser
Aufsatzwaschbecken
Lavabo de apoyo
Раковина умывальника накладная

WHITE

270,00

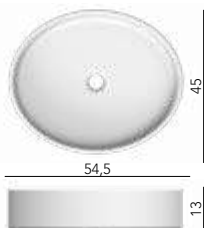

Senza troppo pieno - Consigliata piletta Art. 10034
Without overflow - Waste Art. 10034 recommended
Sans trop-plein - Bonde Art. 10034 conseillée
Ohne überlauf - Abfluss Art. 10034 empfohlen
Sin rebosadero - Recomendado desagüe Art. 10034
Без пробки перелива - Рекомендуется донный клапан арт. 10034

PALLET QUANTITY - 100x120x200h: 50

PALLET QUANTITY - 80x120x200h: 28

BIOKER + 115,00

Art. 8030/R

WIND R - 54,5 x 45 Cm - 11 Kg - 3,5 L.



Lavabo da appoggio
Lay-on washbasin
Lavabo à poser
Aufsatzwaschbecken
Lavabo de apoyo
Раковина умывальника накладная

WHITE

270,00

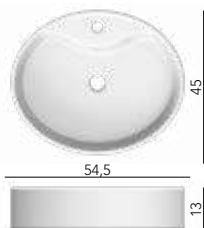

Borchia troppo pieno compresa
Overflow cap included
Anneau trop-plein inclus
Beschlag für Überlaufschutz inklusive
Tachón rebosadero incluido
Перелив входит в комплект

PALLET QUANTITY - 100x120x200h: 50

PALLET QUANTITY - 80x120x200h: 28

BIOKER + 115,00

Art. 10034



Piletta lavabo da 1"1/4
con troppo pieno integrato
1"1/4 washbasin waste with overflow
Bonde lavabo de 1"1/4 avec trop-plein intégré
Waschbeckenabfluss 1"1/4 mit integriertem Überlaufschutz
Desagüe lavabo de 1"1/4 con rebosadero integrado
Донный клапан для умывальника 1"1/4 с интегрированным переливом

CR

200,00

NROP

220,00

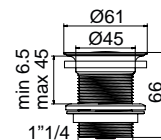

Art. 10010/C



Scarico automatico 1"1/4 click-clack, tappo grande
Automatic pop-waste 1" 1/4 click-clack, big plug
Bonde clic-clac, grand debit
Automatischer ablauf click-clack, crosser stöpsel
Valvula automática 1" 1/4 click-clack, tapón grande
Слив автоматический: клапан 1"1/4, большая пробка

CR / NROP + WHITE 105,00

ORS + WHITE 145,00

CR / NROP + COLORS 130,00

ORS + COLORS 175,00

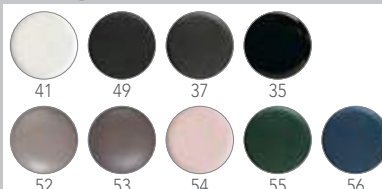



ML 60 x 40
Art. 3001



ML 90 x 40
Art. 3002



ML 120 x 40
Art. 3003



ML 60 x 47
Art. 3004



ML 90 x 47
Art. 3005



ML 120 x 47
Art. 3006



ML 90 x 47 SHELF DX
Art. 3008



ML 90 x 47 SHELF SX
Art. 3009



ML 120 x 47 DOUBLE SHELF
Art. 3007



TOWEL BAR

WC BIDET ABBINABILI

MATCHING WCS AND BIDETS - WC ET BIDET COMBINABLES
KOMBINIERBARE WCS UND BIDETS - WC BIDÉ COMBINABLES
УНИТАЗЫ БИДЕ КОМБИНИРУЕМЫЕ



P_8

Art. 5520/CL - 50,5 x 36 - CLEAN FLUSH
Art. 5521 - 50,5 x 36



P_11

Art. 5524/CL - 45 x 35 - CLEAN FLUSH
Art. 5525 - 45 x 35



P_9

Art. 5522 - 54,5 x 36
Art. 5522/CL - 54,5 x 36 - CLEAN FLUSH
Art. 5523 - 54,5 x 36



P_10

Art. 5526/CL - 66 x 36 - CLEAN FLUSH
Art. 5527 - 36 x 15 - CISTERN

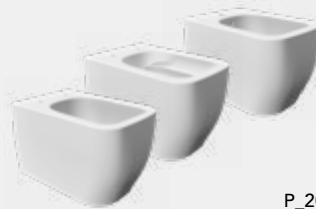

P_20

Art. 5126/TW - 52 x 36 - TWIST
Art. 5126/CL - 52 x 36 - CLEAN FLUSH
Art. 5127 - 52 x 36



P_21

Art. 5138/CL - 55 x 36 - CLEAN FLUSH
Art. 5139 - 55 x 36



P_22

Art. 5140/CL - 66 x 36 - CLEAN FLUSH
Art. 5141 - 35 x 15 - CISTERN



P_48

Art. 5201/TW - 50,5 x 36 - TWIST
Art. 5202 - 50,5 x 36



P_126

Art. 8701 - 50 x 35
Art. 8702 - 50 x 35



P_58

Art. 8812 - 53,5 x 36
Art. 8812/CL - 53,5 x 36 - CLEAN FLUSH
Art. 8813 - 53,5 x 36
Art. 8815 - 40 x 29 - KIDS WC

Art. 3001

ML 60 x 40 - 60 x 40 Cm - 16 Kg - 4 L.

WHITE

395,00



Lavabo da incasso o sospeso

Built-in or wall-mounted washbasin

Lavabo encastré ou suspendu

Einbau-oder Hängewaschbecken

Lavabo de encaje o suspendido

Раковина умывальника встраиваемая или подвесная

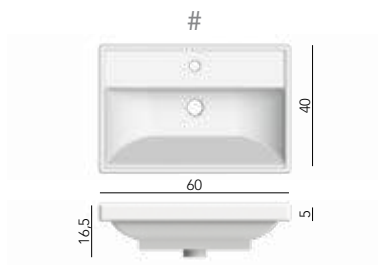

Fissaggi a muro compresi - Borchia troppo pieno compresa

Wall attachments included - Overflow cap included

Fixations murales incluses - Anneau trop-plein inclus

Wandbefestigungen inklusive - Beschlag für Überlaufschutz inklusive

Fijación pared incluida - Tachón rebosadero incluido

Настенные крепления входят в комплект - Перелив входит в комплект

PALLET QUANTITY - 100x120x200h: 40

PALLET QUANTITY - 80x120x200h: 28

BIOKER + 115,00

Art. 3004

ML 60 x 47 - 61,5 x 47 Cm - 17 Kg - 4,5 L.

WHITE

395,00



Lavabo da incasso o sospeso

Built-in or wall-mounted washbasin

Lavabo encastré ou suspendu

Einbau-oder Hängewaschbecken

Lavabo de encaje o suspendido

Раковина умывальника встраиваемая или подвесная



Fissaggi a muro compresi - Borchia troppo pieno compresa

Wall attachments included - Overflow cap included

Fixations murales incluses - Anneau trop-plein inclus

Wandbefestigungen inklusive - Beschlag für Überlaufschutz inklusive

Fijación pared incluida - Tachón rebosadero incluido

Настенные крепления входят в комплект - Перелив входит в комплект

PALLET QUANTITY - 100x120x200h: 40

PALLET QUANTITY - 80x120x200h: 28

BIOKER + 115,00

Art. 3002

ML 90 x 40 - 92 x 39 Cm - 21 Kg - 5 L.

WHITE

495,00



Lavabo da incasso o sospeso

Built-in or wall-mounted washbasin

Lavabo encastré ou suspendu

Einbau-oder Hängewaschbecken

Lavabo de encaje o suspendido

Раковина умывальника встраиваемая или подвесная



Fissaggi a muro compresi - Borchia troppo pieno compresa

Wall attachments included - Overflow cap included

Fixations murales incluses - Anneau trop-plein inclus

Wandbefestigungen inklusive - Beschlag für Überlaufschutz inklusive

Fijación pared incluida - Tachón rebosadero incluido

Настенные крепления входят в комплект - Перелив входит в комплект

PALLET QUANTITY - 100x120x200h: 20

PALLET QUANTITY - 80x120x200h: 13

BIOKER + 115,00

Art. 3005

ML 90 x 47 - 92 x 47 Cm - 22 Kg - 5,5 L.

Lavabo da incasso o sospeso
 Built-in or wall-mounted washbasin
 Lavabo encastré ou suspendu
 Einbau-oder Hängewaschbecken
 Lavabo de encaje o suspendido
 Раковина умывальника встраиваемая или подвесная

WHITE 495,00



Fissaggi a muro compresi - Borchia troppo pieno compresa
 Wall attachments included - Overflow cap included
 Fixations murales incluses - Anneau trop-plein inclus
 Wandbefestigungen inklusive - Beschlag für Überlaufschutz inklusive
 Fijación pared incluida - Tachón rebosadero incluido
 Настенные крепления входят в комплект - Перелив входит в комплект

PALLET QUANTITY - 100x120x200h: 20
 PALLET QUANTITY - 80x120x200h: 13

BIOKER + 115,00

Art. 3003

ML 120 x 40 - 122 x 40 Cm - 28 Kg - 4 L.

Lavabo da incasso o sospeso
 Built-in or wall-mounted washbasin
 Lavabo encastré ou suspendu
 Einbau-oder Hängewaschbecken
 Lavabo de encaje o suspendido
 Раковина умывальника встраиваемая или подвесная

WHITE 640,00



Fissaggi a muro compresi - Borchia troppo pieno compresa
 Wall attachments included - Overflow cap included
 Fixations murales incluses - Anneau trop-plein inclus
 Wandbefestigungen inklusive - Beschlag für Überlaufschutz inklusive
 Fijación pared incluida - Tachón rebosadero incluido
 Настенные крепления входят в комплект - Перелив входит в комплект

PALLET QUANTITY - 100x120x200h: 17
 PALLET QUANTITY - 80x120x200h: 13

BIOKER + 115,00

Art. 3006

ML 120 x 47 - 122 x 47 Cm - 30 Kg - 4 L.

Lavabo da incasso o sospeso
 Built-in or wall-mounted washbasin
 Lavabo encastré ou suspendu
 Einbau-oder Hängewaschbecken
 Lavabo de encaje o suspendido
 Раковина умывальника встраиваемая или подвесная

WHITE 640,00

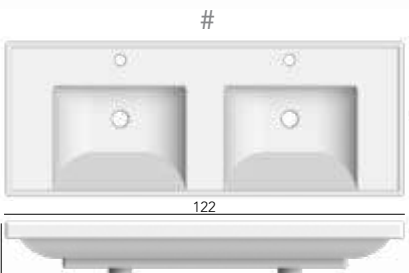

Fissaggi a muro compresi - Borchia troppo pieno compresa
 Wall attachments included - Overflow cap included
 Fixations murales incluses - Anneau trop-plein inclus
 Wandbefestigungen inklusive - Beschlag für Überlaufschutz inklusive
 Fijación pared incluida - Tachón rebosadero incluido
 Настенные крепления входят в комплект - Перелив входит в комплект

PALLET QUANTITY - 100x120x200h: 17
 PALLET QUANTITY - 80x120x200h: 13

BIOKER + 115,00

Art. 3008

ML 90 x 47 SHELF DX - 92 x 47 Cm - 22 Kg - 4 L.



Lavabo da incasso o sospeso

Built-in or wall-mounted washbasin

Lavabo encastré ou suspendu

Einbau-oder Hängewaschbecken

Lavabo de encaje o suspendido

Раковина умывальника встраиваемая или подвесная

WHITE

495,00



Fissaggi a muro compresi - Borchia troppo pieno compresa

Wall attachments included - Overflow cap included

Fixations murales incluses - Anneau trop-plein inclus

Wandbefestigungen inklusive - Beschlag für Überlaufschutz inklusive

Fijación pared incluida - Tachón rebosadero incluido

Настенные крепления входят в комплект - Перелив входит в комплект

PALLET QUANTITY - 100x120x200h: 20

PALLET QUANTITY - 80x120x200h: 13

BIOKER + 115,00

Art. 3009

ML 90 x 47 SHELF SX - 92 x 47 Cm - 22 Kg - 4 L.



Lavabo da incasso o sospeso

Built-in or wall-mounted washbasin

Lavabo encastré ou suspendu

Einbau-oder Hängewaschbecken

Lavabo de encaje o suspendido

Раковина умывальника встраиваемая или подвесная

WHITE

495,00



Fissaggi a muro compresi - Borchia troppo pieno compresa

Wall attachments included - Overflow cap included

Fixations murales incluses - Anneau trop-plein inclus

Wandbefestigungen inklusive - Beschlag für Überlaufschutz inklusive

Fijación pared incluida - Tachón rebosadero incluido

Настенные крепления входят в комплект - Перелив входит в комплект

PALLET QUANTITY - 100x120x200h: 20

PALLET QUANTITY - 80x120x200h: 13

BIOKER + 115,00

Art. 3007

ML 120 x 47 DOUBLE SHELF - 121 x 46,5 Cm - 28 Kg - 5,5 L.



Lavabo da incasso o sospeso

Built-in or wall-mounted washbasin

Lavabo encastré ou suspendu

Einbau-oder Hängewaschbecken

Lavabo de encaje o suspendido

Раковина умывальника встраиваемая или подвесная

WHITE

640,00



Fissaggi a muro compresi - Borchia troppo pieno compresa

Wall attachments included - Overflow cap included

Fixations murales incluses - Anneau trop-plein inclus

Wandbefestigungen inklusive - Beschlag für Überlaufschutz inklusive

Fijación pared incluida - Tachón rebosadero incluido

Настенные крепления входят в комплект - Перелив входит в комплект

PALLET QUANTITY - 100x120x200h: 17

PALLET QUANTITY - 80x120x200h: 13

BIOKER + 115,00

TOWEL BAR



Porta asciugamani
Towel bar
Porte-Serviettes
Handtuchhalter
Toallero
Держатель полотенец

Art. 10042 - L 59 Cm

Per - For - Pour - Für - Para - Для: Art.: 3001 - 3004

CR ● 220,00

Art. 10044 - L 90 Cm

Per - For - Pour - Für - Para - Для: Art.: 3002 - 3005 - 3008 - 3009

CR ● 235,00

Art. 10046 - L 118 Cm

Per - For - Pour - Für - Para - Для: Art.: 3003 - 3006 - 3007

CR ● 235,00

Art. 10034

Piletta lavabo da 1"1/4
con troppo pieno integrato
1"1/4 washbasin waste with overflow
Bonde lavabo de 1"1/4 avec trop-plein intégré
Waschbeckenabfluss 1"1/4 mit integriertem Überlaufschutz
Desagüe lavabo de 1"1/4 con rebosadero integrado
Донный клапан для умывальника 1"1/4 с интегрированным переливом

CR ● 200,00

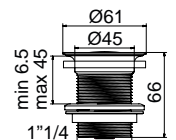
NROP ● 220,00

Art. 10010/C

Scarico automatico 1"1/4 click-clack, tappo grande
Automatic pop-waste 1" 1/4 click-clack, big plug
Bonde clic-clac, grand debit
Automatischer ablauf click-clack, crosser stöpsel
Valvula automática 1" 1/4 click-clack, tapón grande
Слив автоматический: клапан 1"1/4, большая пробка

CR ● / **NROP** ● + **WHITE** 105,00

ORS ● + **WHITE** 145,00



GAIA 50
Art. 8032



GAIA 80
Art. 8033



TECH
Art. 8037



MIKY 35
Art. 8089



MIKY 40
Art. 8090



MIKY 50
Art. 8091



MIKY 80
Art. 8092

WC BIDET ABBINABILI

MATCHING WCS AND BIDETS - WC ET BIDET COMBINABLES
KOMBINIERBARE WCS UND BIDETS - WC BIDÉ COMBINABLES
УНИТАЗЫ БИДЕ КОМБИНИРУЕМЫЕ



P_8

Art. 5520/CL - 50,5 x 36 - CLEAN FLUSH
Art. 5521 - 50,5 x 36



P_11

Art. 5524/CL - 45 x 35 - CLEAN FLUSH
Art. 5525 - 45 x 35



P_9

Art. 5522 - 54,5 x 36
Art. 5522/CL - 54,5 x 36 - CLEAN FLUSH
Art. 5523 - 54,5 x 36



P_10

Art. 5526/CL - 66 x 36 - CLEAN FLUSH
Art. 5527 - 36 x 15 - CISTERN

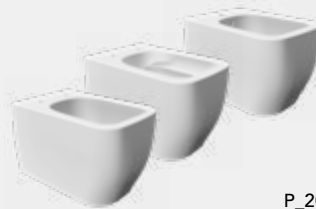

P_20

Art. 5126/TW - 52 x 36 - TWIST
Art. 5126/CL - 52 x 36 - CLEAN FLUSH
Art. 5127 - 52 x 36



P_21

Art. 5138/CL - 55 x 36 - CLEAN FLUSH
Art. 5139 - 55 x 36



P_22

Art. 5140/CL - 66 x 36 - CLEAN FLUSH
Art. 5141 - 35 x 15 - CISTERN



P_48

Art. 5201/TW - 50,5 x 36 - TWIST
Art. 5202 - 50,5 x 36



P_126

Art. 8701 - 50 x 35
Art. 8702 - 50 x 35



P_58

Art. 8812 - 53,5 x 36
Art. 8812/CL - 53,5 x 36 - CLEAN FLUSH
Art. 8813 - 53,5 x 36
Art. 8815 - 40 x 29 - KIDS WC

Art. 8032
GAIA 50 - 56 x 39,5 Cm - 14 Kg - 5,5 L.

Lavabo da incasso
 Built-in washbasin
 Lavabo encastré par dessus
 Einbauwaschbecken
 Lavabo de encaje
 Раковина умывальника встраиваемая

WHITE
295,00

Borchia troppo pieno compresa
 Overflow cap included
 Anneau trop-plein inclus
 Beschlag für Überlaufschutz inklusive
 Tachón rebosadero incluido
 Перелив входит в комплект

PALLET QUANTITY - 100x120x200h: 40
 PALLET QUANTITY - 80x120x200h: 32

BIOKER + 115,00
Art. 8033
GAIA 80 - 87,5 x 39,5 Cm - 18 Kg - 9 L.

Lavabo da incasso
 Built-in washbasin
 Lavabo encastré par dessus
 Einbauwaschbecken
 Lavabo de encaje
 Раковина умывальника встраиваемая

WHITE
390,00

Borchia troppo pieno compresa
 Overflow cap included
 Anneau trop-plein inclus
 Beschlag für Überlaufschutz inklusive
 Tachón rebosadero incluido
 Перелив входит в комплект

PALLET QUANTITY - 100x120x200h: 26
 PALLET QUANTITY - 80x120x200h: 16

BIOKER + 115,00
Art. 8037
TECH - 54,5 x 36 Cm - 14 Kg - 6 L.

Lavabo sottopiano
 Under-top washbasin
 Lavabo encastré par dessous
 Unterbauwaschbecken
 Lavabo bajo encimera
 Раковина умывальника под столешницу

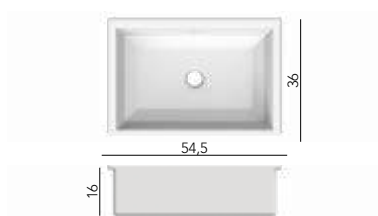
WHITE
295,00

Fissaggi compresi - Borchia troppo pieno compresa
 Attachments included - Overflow cap included
 Fixations incluses - Anneau trop-plein inclus
 Befestigungen inklusive - Beschlag für Überlaufschutz inklusive
 Fijación incluida - Tachón rebosadero incluido
 Крепления входят в комплект - Перелив входит в комплект

PALLET QUANTITY - 100x120x200h: 40
 PALLET QUANTITY - 80x120x200h: 32

BIOKER + 115,00

Art. 8089

MIKY 35 - 42 x 42 Cm - 12 Kg - 7 L.



Lavabo sottopiano
 Under-top washbasin
 Lavabo encastré par dessous
 Unterbauwaschbecken
 Lavabo bajo encimera
 Раковина умывальника под столешницу

WHITE

280,00

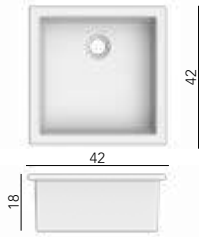

Fissaggi compresi - Senza troppo pieno - Consigliata piletta Art. 10034
 Attachments included - Without overflow - Waste Art. 10034 recommended
 Fixations incluses - Sans trop-plein - Bonde Art. 10034 conseillée
 Befestigungen inklusive - Ohne überlauf - Abfluss Art. 10034 empfohlen
 Fijación incluida - Sin rebosadero - Recomendado desagüe Art. 10034
 Крепления входят в комплект - Без пробки перелива - Рекомендуется донный клапан арт. 10034

PALLET QUANTITY - 100x120x200h: 40

PALLET QUANTITY - 80x120x200h: 23

BIOKER + 115,00

Art. 8090

MIKY 40 - 47 x 30,5 Cm - 12 Kg - 10 L.



Lavabo sottopiano
 Under-top washbasin
 Lavabo encastré par dessous
 Unterbauwaschbecken
 Lavabo bajo encimera
 Раковина умывальника под столешницу

WHITE

280,00



Fissaggi compresi - Borchia troppo pieno compresa
 Attachments included - Overflow cap included
 Fixations incluses - Anneau trop-plein inclus
 Befestigungen inklusive - Beschlag für Überlaufschutz inklusive
 Fijación incluida - Tachón rebosadero incluido
 Крепления входят в комплект - Перелив входит в комплект

PALLET QUANTITY - 100x120x200h: 50

PALLET QUANTITY - 80x120x200h: 28

BIOKER + 115,00

Art. 8091

MIKY 50 - 57 x 30,5 Cm - 14 Kg - 12 L.



Lavabo sottopiano
 Under-top washbasin
 Lavabo encastré par dessous
 Unterbauwaschbecken
 Lavabo bajo encimera
 Раковина умывальника под столешницу

WHITE

295,00



Fissaggi compresi - Borchia troppo pieno compresa
 Attachments included - Overflow cap included
 Fixations incluses - Anneau trop-plein inclus
 Befestigungen inklusive - Beschlag für Überlaufschutz inklusive
 Fijación incluida - Tachón rebosadero incluido
 Крепления входят в комплект - Перелив входит в комплект

PALLET QUANTITY - 100x120x200h: 45

PALLET QUANTITY - 80x120x200h: 24

BIOKER + 115,00

Art. 8092

MIKY 80 - 87 x 32 Cm - 20 Kg - 17 L.

Lavabo sottopiano
 Under-top washbasin
 Lavabo encastré par dessous
 Unterbauwaschbecken
 Lavabo bajo encimera
 Раковина умывальника под столешницу

WHITE

390,00

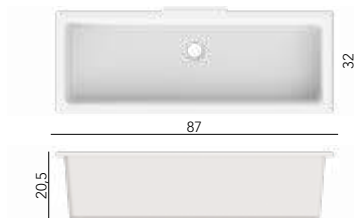

Fissaggi compresi - Borchia troppo pieno compresa
 Attachments included - Overflow cap included
 Fixations incluses - Anneau trop-plein inclus
 Befestigungen inklusive - Beschlag für Überlaufschutz inklusive
 Fijación incluida - Tachón rebosadero incluido
 Крепления входят в комплект - Перелив входит в комплект

PALLET QUANTITY - 100x120x200h: 25
 PALLET QUANTITY - 80x120x200h: 13

BIOKER + 115,00

Art. 10034

Piletta lavabo da 1"1/4 con troppo pieno integrato
 1"1/4 washbasin waste with overflow
 Bonde lavabo de 1"1/4 avec trop-plein intégré
 Waschbeckenabfluss 1"1/4 mit integriertem Überlaufschutz
 Desagüe lavabo de 1"1/4 con rebosadero integrado
 Донный клапан для умывальника 1"1/4 с интегрированным переливом

CR ●

200,00

NROP ●

220,00

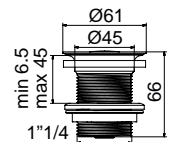

Art. 10010/C

Scarico automatico 1"1/4 click-clack, tappo grande
 Automatic pop-waste 1" 1/4 click-clack, big plug
 Bonde clic-clac, grand debit
 Automatischer ablauf click-clack, crosser stöpsel
 Valvula automática 1" 1/4 click-clack, tapón grande
 Слив автоматический: клапан 1"1/4, большая пробка

CR ● / NROP ● + WHITE 105,00

ORS ● + WHITE

145,00





TEOREMA HUNG WC
Art. 8701



TEOREMA HUNG BIDET
Art. 8702



TEOREMA 40
Art. 8031-40



TEOREMA 46
Art. 8031



TEOREMA 60
Art. 8031-60



TEOREMA 80
Art. 8031-80



TEOREMA 30R
Art. 8036



TEOREMA 41x23R
Art. 8031/R-41x23



TEOREMA 40x35R
Art. 5001



TEOREMA 60x35R
Art. 5002



TEOREMA 40R
Art. 8031/R-40



TEOREMA 46R
Art. 8031/R



TEOREMA 46D
Art. 8031/D



TEOREMA 60R
Art. 8031/R-60



TEOREMA 100R
Art. 8031/R-100/A
Art. 8031/R-100/B



TEOREMA 120R
Art. 8031/R-120/A
Art. 8031/R-120/B



TEOREMA 105R
Art. 8035



CONSOLE



TOWEL BAR

WC BIDET ABBINABILI

MATCHING WCS AND BIDETS - WC ET BIDET COMBINABLES
 KOMBINIERBARE WCS UND BIDETS - WC BIDÉ COMBINABLES
 УНИТАЗЫ БИДЕ КОМБИНИРУЕМЫЕ



P_8

Art. 5520/CL - 50,5 x 36 - CLEAN FLUSH
 Art. 5521 - 50,5 x 36



P_11

Art. 5524/CL - 45 x 35 - CLEAN FLUSH
 Art. 5525 - 45 x 35



P_9

Art. 5522 - 54,5 x 36
 Art. 5522/CL - 54,5 x 36 - CLEAN FLUSH
 Art. 5523 - 54,5 x 36



P_10

Art. 5526/CL - 66 x 36 - CLEAN FLUSH
 Art. 5527 - 36 x 15 - CISTERN



TEOREMA 80X35R
 Art. 5003



TEOREMA 80R
 Art. 8031/R-80

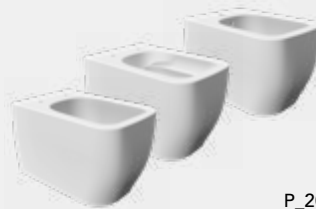

P_20

Art. 5126/TW - 52 x 36 - TWIST
 Art. 5126/CL - 52 x 36 - CLEAN FLUSH
 Art. 5127 - 52 x 36



P_21

Art. 5138/CL - 55 x 36 - CLEAN FLUSH
 Art. 5139 - 55 x 36



P_22

Art. 5140/CL - 66 x 36 - CLEAN FLUSH
 Art. 5141 - 35 x 15 - CISTERN



P_48

Art. 5201/TW - 50,5 x 36 - TWIST
 Art. 5202 - 50,5 x 36



P_58

Art. 8812 - 53,5 x 36
 Art. 8812/CL - 53,5 x 36 - CLEAN FLUSH
 Art. 8813 - 53,5 x 36
 Art. 8815 - 40 x 29 - KIDS WC

Art. 8701

TEOREMA HUNG WC - 50 x 36 Cm - 22 Kg



Wc Sospeso
Wall-mounted WC
Cuvette suspendue
Hänge-WC
Inodoro suspendido
Унитаз подвесной



WHITE

380,00

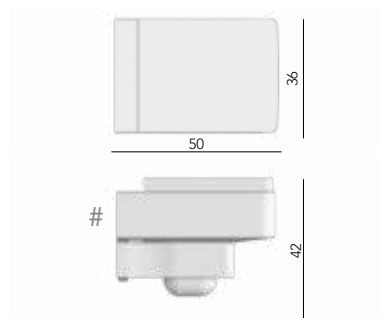

Senza staffe - Aggiungere fissaggio rapido
Without fixing set - Add quick fixing kit
Sans équerres - Ajouter fixation rapide
Ohne Befestigungselemente und Bügel - Schnellverbindung hinzufügen
Sin soportes - Añadir fijación rápida
Без скоб - Дополнительное набор быстрого монтажа

PALLET QUANTITY - 100x120x200h: 20+CW
PALLET QUANTITY - 80x120x200h: 14+CW

BIOKER + 115,00

Art. 8702

TEOREMA HUNG BIDET - 50 x 36 Cm - 22 Kg



Bidet sospeso
Wall-mounted bidet
Bidet suspendu
Hänge-Bidet
Bidet suspendido
Биде подвесное

WHITE

380,00

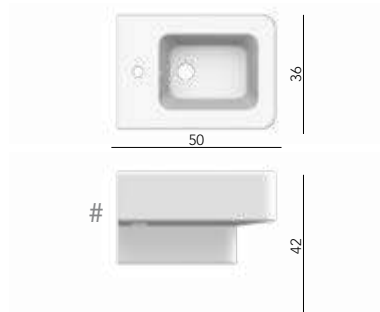

Senza staffe - Aggiungere fissaggio rapido
Borchia troppo pieno compresa
Without fixing set - Add quick fixing kit
Overflow cap included
Sans équerres - Ajouter fixation rapide
Anneau trop-plein inclus
Ohne Befestigungselemente und Bügel - Schnellverbindung hinzufügen
Beschlag für Überlaufschutz inklusive
Sin soportes - Añadir fijación rápida
Tachón rebosadero incluido
Без скоб - Дополнительное набор быстрого монтажа
Перелив входит в комплект

PALLET QUANTITY - 100x120x200h: 24
PALLET QUANTITY - 80x120x200h: 16

BIOKER + 115,00

+ Art. 10050/A - STANDARD

20,00

+ Art. 10050/B - WB9 2.0 CLICK SYSTEM

25,00



Fissaggio Rapido per Sanitari
Quick fixing kit for sanitary fittings
Fixation rapide pour sanitaires
Schnellverbindung für Sanitäreanlagen
Fijación rápida para sanitarios
Набор быстрого монтажа для сантехники



Fissaggio Rapido per Sanitari
Quick fixing kit for sanitary fittings
Fixation rapide pour sanitaires
Schnellverbindung für Sanitäreanlagen
Fijación rápida para sanitarios
Набор быстрого монтажа для сантехники

Art. 8703/A

TEOREMA SEAT COVER

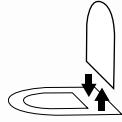

Sedile per Wc in termoindurente
 Seat cover Wc in thermosetting resin
 Abattant wc en matière thermodurcissable
 WC-deckel Duroplas
 Asiento para inodoro en material termoenduracido
 Сиденье унитаза из терморезистивного полимера

WHITE

140,00

Con cerniere cromate - Sgancio rapido
 With chromed Kit - Rapid lift system
 Charnières chromées - Décrochage rapide
 Mit scharniere chrom - Schnellbefestigung
 Bisagras cromadas - Desenganche rápido
 С хромированными шарнирами - Быстрое отсоединение

Art. 8703/B

TEOREMA SEAT COVER

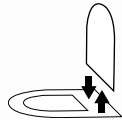

Sedile per Wc in termoindurente
 Seat cover Wc in thermosetting resin
 Abattant wc en matière thermodurcissable
 WC-deckel Duroplas
 Asiento para inodoro en material termoenduracido
 Сиденье унитаза из терморезистивного полимера

WHITE

185,00

Con cerniera rallentata - Sgancio rapido
 With soft close system - Rapid lift system
 Charnieres avec frein de chute - Décrochage rapide
 Mit sanft abgebremsten scharnieren - Schnellbefestigung
 Con caída amortiguada - Desenganche rápido
 С микролифтом - Быстрое отсоединение

Art. 10005

FIXING SET



Staffe di montaggio Wc e bidet
 Fixing attachments for Wc and bidet
 Supports de montage pour cuvette et bidets suspendus
 Montagebügel Für Hänge-wc und bidet
 Soportes de montaje inodoro y bidé
 Монтажные кронштейны для унитаза и биде

--

70,00

Art. 8031-40

TEOREMA 40 - 39 x 39 Cm - 10 Kg - 8 L.



Lavabo da appoggio
Lay-on washbasin
Lavabo à poser
Aufsatzwaschbecken
Lavabo de apoyo
Раковина умывальника накладная

WHITE

335,00

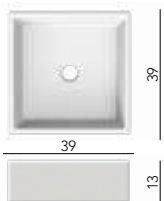

Senza troppo pieno - Consigliata piletta Art. 10034
Without overflow - Waste Art. 10034 recommended
Sans trop-plein - Bonde Art. 10034 conseillée
Ohne überlauf - Abfluss Art. 10034 empfohlen
Sin rebosadero - Recomendado desagüe Art. 10034
Без пробки перелива - Рекомендуется донный клапан арт. 10034

PALLET QUANTITY - 100x120x200h: 68
PALLET QUANTITY - 80x120x200h: 40

BIOKER + 115,00

Art. 8031

TEOREMA 46 - 46 x 46 Cm - 14 Kg - 10 L.



Lavabo da appoggio
Lay-on washbasin
Lavabo à poser
Aufsatzwaschbecken
Lavabo de apoyo
Раковина умывальника накладная

WHITE

355,00



Senza troppo pieno - Consigliata piletta Art. 10034
Without overflow - Waste Art. 10034 recommended
Sans trop-plein - Bonde Art. 10034 conseillée
Ohne überlauf - Abfluss Art. 10034 empfohlen
Sin rebosadero - Recomendado desagüe Art. 10034
Без пробки перелива - Рекомендуется донный клапан арт. 10034

PALLET QUANTITY - 100x120x200h: 50
PALLET QUANTITY - 80x120x200h: 28

BIOKER + 115,00

Art. 8031-60

TEOREMA 60 - 60,5 x 38,5 Cm - 14 Kg - 12 L.



Lavabo da appoggio
Lay-on washbasin
Lavabo à poser
Aufsatzwaschbecken
Lavabo de apoyo
Раковина умывальника накладная

WHITE

410,00

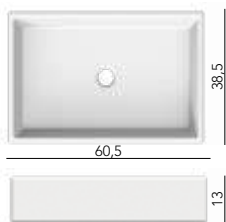

Senza troppo pieno - Consigliata piletta Art. 10034
Without overflow - Waste Art. 10034 recommended
Sans trop-plein - Bonde Art. 10034 conseillée
Ohne überlauf - Abfluss Art. 10034 empfohlen
Sin rebosadero - Recomendado desagüe Art. 10034
Без пробки перелива - Рекомендуется донный клапан арт. 10034

PALLET QUANTITY - 100x120x200h: 40
PALLET QUANTITY - 80x120x200h: 28

BIOKER + 115,00

Art. 8031-80

TEOREMA 80 - 80,5 x 39 Cm - 16 Kg - 14 L.



Lavabo da appoggio
Lay-on washbasin
Lavabo à poser
Aufsatzwaschbecken
Lavabo de apoyo
Раковина умывальника накладная

WHITE

450,00

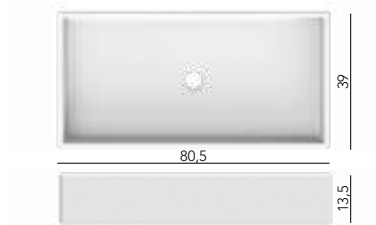

Senza troppo pieno - Consigliata piletta Art. 10034
Without overflow - Waste Art. 10034 recommended
Sans trop-plein - Bonde Art. 10034 conseillée
Ohne überlauf - Abfluss Art. 10034 empfohlen
Sin rebosadero - Recomendado desagüe Art. 10034
Без пробки перелива - Рекомендуется донный клапан арт. 10034

PALLET QUANTITY - 100x120x200h: 32

PALLET QUANTITY - 80x120x200h: 28

BIOKER + 115,00

Art. 8036

TEOREMA 30R - 30 x 30 Cm - 6 Kg - 6 L.



Lavabo da appoggio o sospeso
Lay-on or wall-mounted washbasin
Lavabo à poser ou suspendu
Aufsatz-oder Hängewaschbecken
Lavabo de apoyo o suspendido
Раковина умывальника накладная или подвесная

WHITE

230,00

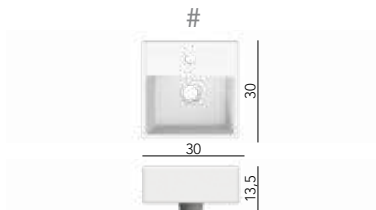

Fissaggi a muro compresi - Senza troppo pieno - Consigliata piletta Art. 10034
Wall attachments included - Without overflow - Waste Art. 10034 recommended
Fixations murales incluses - Sans trop-plein - Bonde Art. 10034 conseillée
Wandbefestigungen inklusive - Ohne überlauf - Abfluss Art. 10034 empfohlen
Fijación pared incluida - Sin rebosadero - Recomendado desagüe Art. 10034
Настенные крепления входят в комплект - Без пробки перелива - Рекомендуется донный клапан арт. 10034

PALLET QUANTITY - 100x120x200h: 102

PALLET QUANTITY - 80x120x200h: 86

BIOKER + 115,00

Art. 8031/R41x23

TEOREMA 41 x 23R - 41 x 23 Cm - 7 Kg - 6 L.



Lavabo da appoggio o sospeso
Lay-on or wall-mounted washbasin
Lavabo à poser ou suspendu
Aufsatz-oder Hängewaschbecken
Lavabo de apoyo o suspendido
Раковина умывальника накладная или подвесная

WHITE

270,00

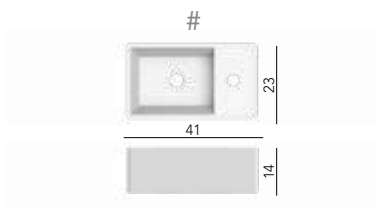

Fissaggi a muro compresi - Senza troppo pieno - Consigliata piletta Art. 10034
Wall attachments included - Without overflow - Waste Art. 10034 recommended
Fixations murales incluses - Sans trop-plein - Bonde Art. 10034 conseillée
Wandbefestigungen inklusive - Ohne überlauf - Abfluss Art. 10034 empfohlen
Fijación pared incluida - Sin rebosadero - Recomendado desagüe Art. 10034
Настенные крепления входят в комплект - Без пробки перелива - Рекомендуется донный клапан арт. 10034

PALLET QUANTITY - 100x120x200h: 110

PALLET QUANTITY - 80x120x200h: 98

BIOKER + 115,00

Art. 5001

TEOREMA 40 x 35R - 41 x 35 Cm - 10 Kg - 2 L.



Lavabo da appoggio o sospeso

Lay-on or wall-mounted washbasin

Lavabo à poser ou suspendu

Aufsatz-oder Hängewaschbecken

Lavabo de apoyo o suspendido

Раковина умывальника накладная или подвесная

WHITE

310,00

#

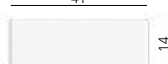

Fissaggi a muro compresi - Borchia troppo pieno compresa

Wall attachments included - Overflow cap included

Fixations murales incluses - Anneau trop-plein inclus

Wandbefestigungen inklusive - Beschlag für Überlaufschutz inklusive

Fijación pared incluida - Tachón rebosadero incluido

Настенные крепления входят в комплект - Перелив входит в комплект

PALLET QUANTITY - 100x120x200h: 68

PALLET QUANTITY - 80x120x200h: 40

BIOKER + 115,00

Art. 5002

TEOREMA 60 x 35R - 60 x 34 Cm - 12 Kg - 3 L.



Lavabo da appoggio o sospeso

Lay-on or wall-mounted washbasin

Lavabo à poser ou suspendu

Aufsatz-oder Hängewaschbecken

Lavabo de apoyo o suspendido

Раковина умывальника накладная или подвесная

WHITE

420,00

#



Fissaggi a muro compresi - Borchia troppo pieno compresa

Wall attachments included - Overflow cap included

Fixations murales incluses - Anneau trop-plein inclus

Wandbefestigungen inklusive - Beschlag für Überlaufschutz inklusive

Fijación pared incluida - Tachón rebosadero incluido

Настенные крепления входят в комплект - Перелив входит в комплект

PALLET QUANTITY - 100x120x200h: 31

PALLET QUANTITY - 80x120x200h: 24

BIOKER + 115,00

Art. 5003

TEOREMA 80 x 35R - 80 x 34 Cm - 14 Kg - 4 L.



Lavabo da appoggio o sospeso

Lay-on or wall-mounted washbasin

Lavabo à poser ou suspendu

Aufsatz-oder Hängewaschbecken

Lavabo de apoyo o suspendido

Раковина умывальника накладная или подвесная

WHITE

465,00

#

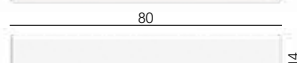

Fissaggi a muro compresi - Borchia troppo pieno compresa

Wall attachments included - Overflow cap included

Fixations murales incluses - Anneau trop-plein inclus

Wandbefestigungen inklusive - Beschlag für Überlaufschutz inklusive

Fijación pared incluida - Tachón rebosadero incluido

Настенные крепления входят в комплект - Перелив входит в комплект

PALLET QUANTITY - 100x120x200h: 32

PALLET QUANTITY - 80x120x200h: 28

BIOKER + 115,00

Art. 8031/R-40

TEOREMA 40R - 42 x 41 Cm - 10 Kg - 2,5 L.



WHITE

345,00

Lavabo da appoggio o sospeso

Lay-on or wall-mounted washbasin

Lavabo à poser ou suspendu

Aufsatz-oder Hängewaschbecken

Lavabo de apoyo o suspendido

Раковина умывальника накладная или подвесная

#

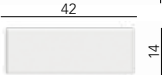

Fissaggi a muro compresi - Borchia troppo pieno compresa

Wall attachments included - Overflow cap included

Fixations murales incluses - Anneau trop-plein inclus

Wandbefestigungen inklusive - Beschlag für Überlaufschutz inklusive

Fijación pared incluida - Tachón rebosadero incluido

Настенные крепления входят в комплект - Перелив входит в комплект

PALLET QUANTITY - 100x120x200h: 68

PALLET QUANTITY - 80x120x200h: 40

BIOKER + 115,00

Art. 8031/R

TEOREMA 46R - 46 x 46 Cm - 14 Kg - 3,5 L.



WHITE

355,00

Lavabo da appoggio o sospeso

Lay-on or wall-mounted washbasin

Lavabo à poser ou suspendu

Aufsatz-oder Hängewaschbecken

Lavabo de apoyo o suspendido

Раковина умывальника накладная или подвесная

#



Fissaggi a muro compresi - Borchia troppo pieno compresa

Wall attachments included - Overflow cap included

Fixations murales incluses - Anneau trop-plein inclus

Wandbefestigungen inklusive - Beschlag für Überlaufschutz inklusive

Fijación pared incluida - Tachón rebosadero incluido

Настенные крепления входят в комплект - Перелив входит в комплект

PALLET QUANTITY - 100x120x200h: 50

PALLET QUANTITY - 80x120x200h: 28

BIOKER + 115,00

Art. 8031/D

TEOREMA 46D - 46 x 46 Cm - 14 Kg - 3,5 L.



WHITE

375,00

Lavabo da semincasso

Semi built-in washbasin

Lavabo semi encastré

Vorbauwaschbecken

Lavabo de semiencaje

Раковина умывальника полувстраиваемая

#



Borchia troppo pieno compresa

Overflow cap included

Anneau trop-plein inclus

Beschlag für Überlaufschutz inklusive

Tachón rebosadero incluido

Перелив входит в комплект

PALLET QUANTITY - 100x120x200h: 50

PALLET QUANTITY - 80x120x200h: 28

BIOKER + 115,00

Art. 8031/R-60

TEOREMA 60R - 60 x 46 Cm - 15 Kg - 4 L.



WHITE

450,00

Lavabo da appoggio o sospeso

Lay-on or wall-mounted washbasin

Lavabo à poser ou suspendu

Aufsatz-oder Hängewaschbecken

Lavabo de apoyo o suspendido

Раковина умывальника накладная или подвесная

#

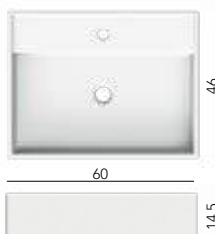

Fissaggi a muro compresi - Borchia troppo pieno compresa

Wall attachments included - Overflow cap included

Fixations murales incluses - Anneau trop-plein inclus

Wandbefestigungen inklusive - Beschlag für Überlaufschutz inklusive

Fijación pared incluida - Tachón rebosadero incluido

Настенные крепления входят в комплект - Перелив входит в комплект

PALLET QUANTITY - 100x120x200h: 34

PALLET QUANTITY - 80x120x200h: 26

BIOKER + 115,00

Art. 8031/R-80

TEOREMA 80R - 80 x 46 Cm - 17 Kg - 5,5 L.



WHITE

480,00

Lavabo da appoggio o sospeso

Lay-on or wall-mounted washbasin

Lavabo à poser ou suspendu

Aufsatz-oder Hängewaschbecken

Lavabo de apoyo o suspendido

Раковина умывальника накладная или подвесная

#

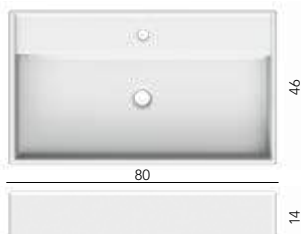

Fissaggi a muro compresi - Borchia troppo pieno compresa

Wall attachments included - Overflow cap included

Fixations murales incluses - Anneau trop-plein inclus

Wandbefestigungen inklusive - Beschlag für Überlaufschutz inklusive

Fijación pared incluida - Tachón rebosadero incluido

Настенные крепления входят в комплект - Перелив входит в комплект

PALLET QUANTITY - 100x120x200h: 28

PALLET QUANTITY - 80x120x200h: 25

BIOKER + 115,00

Art. 8031/R-100A

TEOREMA 100R A - 100 x 46 Cm - 24 Kg - 7 L.



WHITE

610,00

Lavabo da appoggio o sospeso

Lay-on or wall-mounted washbasin

Lavabo à poser ou suspendu

Aufsatz-oder Hängewaschbecken

Lavabo de apoyo o suspendido

Раковина умывальника накладная или подвесная

#

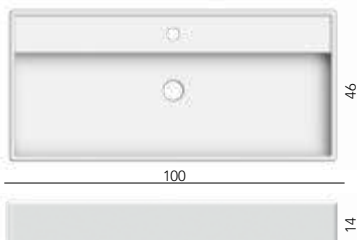

Fissaggi a muro compresi - Borchia troppo pieno compresa

Wall attachments included - Overflow cap included

Fixations murales incluses - Anneau trop-plein inclus

Wandbefestigungen inklusive - Beschlag für Überlaufschutz inklusive

Fijación pared incluida - Tachón rebosadero incluido

Настенные крепления входят в комплект - Перелив входит в комплект

PALLET QUANTITY - 100x120x200h: 20

PALLET QUANTITY - 80x120x200h: 16

BIOKER + 115,00

Art. 8031/R-100B

TEOREMA 100R B - 100 x 46 Cm - 24 Kg - 7 L.

WHITE

610,00



Lavabo da appoggio o sospeso

Lay-on or wall-mounted washbasin

Lavabo à poser ou suspendu

Aufsatz-oder Hängewaschbecken

Lavabo de apoyo o suspendido

Раковина умывальника накладная или подвесная

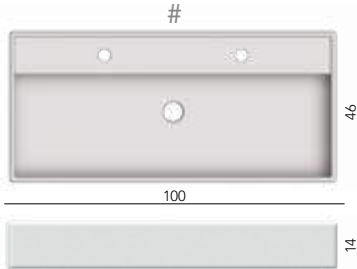

Fissaggi a muro compresi - Borchia troppo pieno compresa

Wall attachments included - Overflow cap included

Fixations murales incluses - Anneau trop-plein inclus

Wandbefestigungen inklusive - Beschlag für Überlaufschutz inklusive

Fijación pared incluida - Tachón rebosadero incluido

Настенные крепления входят в комплект - Перелив входит в комплект

PALLET QUANTITY - 100x120x200h: 20

PALLET QUANTITY - 80x120x200h: 16

BIOKER + 115,00

Art. 8031/R-120A

TEOREMA 120R A - 120 x 46 Cm - 30 Kg - 8 L.

WHITE

740,00



Lavabo da appoggio o sospeso

Lay-on or wall-mounted washbasin

Lavabo à poser ou suspendu

Aufsatz-oder Hängewaschbecken

Lavabo de apoyo o suspendido

Раковина умывальника накладная или подвесная

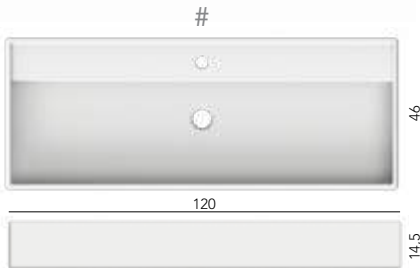

Fissaggi a muro compresi - Borchia troppo pieno compresa

Wall attachments included - Overflow cap included

Fixations murales incluses - Anneau trop-plein inclus

Wandbefestigungen inklusive - Beschlag für Überlaufschutz inklusive

Fijación pared incluida - Tachón rebosadero incluido

Настенные крепления входят в комплект - Перелив входит в комплект

PALLET QUANTITY - 100x120x200h: 17

PALLET QUANTITY - 80x120x200h: 13

BIOKER + 115,00

Art. 8031/R-120B

TEOREMA 120R B - 120 x 46 Cm - 30 Kg - 8 L.

WHITE

740,00



Lavabo da appoggio o sospeso

Lay-on or wall-mounted washbasin

Lavabo à poser ou suspendu

Aufsatz-oder Hängewaschbecken

Lavabo de apoyo o suspendido

Раковина умывальника накладная или подвесная

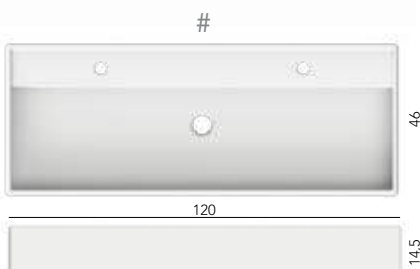

Fissaggi a muro compresi - Borchia troppo pieno compresa

Wall attachments included - Overflow cap included

Fixations murales incluses - Anneau trop-plein inclus

Wandbefestigungen inklusive - Beschlag für Überlaufschutz inklusive

Fijación pared incluida - Tachón rebosadero incluido

Настенные крепления входят в комплект - Перелив входит в комплект

PALLET QUANTITY - 100x120x200h: 17

PALLET QUANTITY - 80x120x200h: 13

BIOKER + 115,00

Art. 8035

TEOREMA 105R - 106 x 46 Cm - 30 Kg - 8 L.



Lavabo da appoggio o sospeso

Lay-on or wall-mounted washbasin

Lavabo à poser ou suspendu

Aufsatz-oder Hängewaschbecken

Lavabo de apoyo o suspendido

Раковина умывальника накладная или подвесная

WHITE

650,00

#

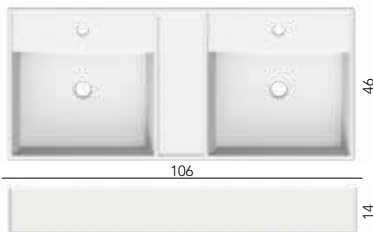

Fissaggi a muro compresi - Borchia troppo pieno compresa

Wall attachments included - Overflow cap included

Fixations murales incluses - Anneau trop-plein inclus

Wandbefestigungen inklusive - Beschlag für Überlaufschutz inklusive

Fijación pared incluida - Tachón rebosadero incluido

Настенные крепления входят в комплект - Перелив входит в комплект

PALLET QUANTITY - 100x120x200h: 20

PALLET QUANTITY - 80x120x200h: 16

BIOKER + 115,00

CONSOLE FOR WASHBASIN



Consolle per lavabo

Console for washbasin

Console pour lavabo

Konsole für waschbecken

Consolle para lavabo

Подставка под раковину
умывальника

Art. 10060 - L 58 P 44,5 H 76 Cm

Per - For - Pour - Für - Para - Для: Art.: 8031/R60

CR ● **670,00**

NROP ● **710,00**

Art. 10061 - L 78 P 44,5 H 76 Cm

Per - For - Pour - Für - Para - Для: Art.: 8031/R80

CR ● **670,00**

NROP ● **710,00**

Art. 10062 - L 98 P 44,5 H 76 Cm

Per - For - Pour - Für - Para - Для: Art.: 8031/R-100/A - 8031/R-100/B

CR ● **780,00**

NROP ● **810,00**

Art. 10063 - L 118 P 44,5 H 76 Cm

Per - For - Pour - Für - Para - Для: Art.: 8031/R-120/A - 8031/R-120/B

CR ● **780,00**

NROP ● **810,00**

TOWEL BAR



Porta asciugamani
Towel bar
Porte-Serviettes
Handtuchhalter
Toallero
Держатель полотенец

Art. 10040 - L 40 Cm

Per - For - Pour - Für - Para - Для: Art.: 8031/R41x23 - 8031/R40 - 5001

CR **170,00**
NROP **185,00**

Art. 10041 - L 45 Cm

Per - For - Pour - Für - Para - Для: Art.: 8031/R

CR **180,00**
NROP **205,00**

Art. 10042 - L 59 Cm

Per - For - Pour - Für - Para - Для: Art.: 8031/R60 - 5002

CR **220,00**
NROP **240,00**

Art. 10043 - L 79 Cm

Per - For - Pour - Für - Para - Для: Art.: 8031/R80 - 5003

CR **235,00**
NROP **255,00**

Art. 10045 - L 98 Cm

Per - For - Pour - Für - Para - Для: Art.: 8031/R-100/A - 8031/R-100/B

CR **235,00**
NROP **255,00**

Art. 10046 - L 118 Cm

Per - For - Pour - Für - Para - Для: Art.: 8031/R-120/A - 8031/R-120/B

CR **235,00**
NROP **255,00**

Art. 10034



Piletta lavabo da 1"1/4
con troppo pieno integrato
1"1/4 washbasin waste with overflow
Bonde lavabo de 1"1/4 avec trop-plein intégré
Waschbeckenabfluss 1"1/4 mit integriertem Überlaufschutz
Desagüe lavabo de 1"1/4 con rebosadero integrado
Донный клапан для умывальника 1"1/4 с интегрированным переливом

CR **200,00**
NROP **220,00**

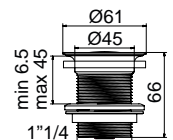

Art. 10010/C



Scarico automatico 1"1/4 click-clack, tappo grande
Automatic pop-waste 1" 1/4 click-clack, big plug
Bonde clic-clac, grand debit
Automatischer ablauf click-clack, crosser stöpsel
Valvula automática 1" 1/4 click-clack, tapón grande
Слив автоматический: клапан 1"1/4, большая пробка

CR / NROP + WHITE **105,00**
ORS + WHITE **145,00**



MATTY TONDO
Art. 8055



MATTY TONDO R
Art. 8055/R



MATTY TONDO A
Art. 8055/A



MATTY TONDO A/R
Art. 8055/A/R



MATTY OVALE
Art. 8056



MATTY OVALE R
Art. 8056/R



MATTY OVALE A
Art. 8056/A



MATTY OVALE A/R
Art. 8056/A/R

WC BIDET ABBINABILI

MATCHING WCS AND BIDETS - WC ET BIDET COMBINABLES
 KOMBINIERBARE WCS UND BIDETS - WC BIDÉ COMBINABLES
 УНИТАЗЫ БИДЕ КОМБИНИРУЕМЫЕ



P_8

Art. 5520/CL - 50,5 x 36 - CLEAN FLUSH
 Art. 5521 - 50,5 x 36



P_11

Art. 5524/CL - 45 x 35 - CLEAN FLUSH
 Art. 5525 - 45 x 35



P_9

Art. 5522 - 54,5 x 36
 Art. 5522/CL - 54,5 x 36 - CLEAN FLUSH
 Art. 5523 - 54,5 x 36



P_10

Art. 5526/CL - 66 x 36 - CLEAN FLUSH
 Art. 5527 - 36 x 15 - CISTERN



P_76

Art. 8604 - 55 x 41
 Art. 8605 - 55 x 41



P_76/77

Art. 8606 - 55 x 41
 Art. 8607 - 55 x 41



P_68

Art. 8105 - 50 x 45
 Art. 8105/CL - 50 x 45 - CLEAN FLUSH
 Art. 8106 - 50 x 45



P_69

Art. 8401 - 50 x 45
 Art. 8403 - 50 x 45



P_69

Art. 8404 - 38 x 14,5 x h95,5

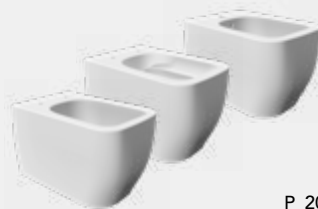

P_20

Art. 5126/TW - 52 x 36 - TWIST
 Art. 5126/CL - 52 x 36 - CLEAN FLUSH
 Art. 5127 - 52 x 36



P_21

Art. 5138/CL - 55 x 36 - CLEAN FLUSH
 Art. 5139 - 55 x 36



P_22

Art. 5140/CL - 66 x 36 - CLEAN FLUSH
 Art. 5141 - 35 x 15 - CISTERN



P_48

Art. 5201/TW - 50,5 x 36 - TWIST
 Art. 5202 - 50,5 x 36



P_126

Art. 8701 - 50 x 35
 Art. 8702 - 50 x 35



P_58

Art. 8812 - 53,5 x 36
 Art. 8812/CL - 53,5 x 36 - CLEAN FLUSH
 Art. 8813 - 53,5 x 36
 Art. 8815 - 40 x 29 - KIDS WC

Art. 8055

MATTY TONDO - Ø46 Cm - 17 Kg - 8 L.



Lavabo da appoggio
Lay-on washbasin
Lavabo à poser
Aufsatzwaschbecken
Lavabo de apojo
Раковина умывальника накладная

WHITE

390,00

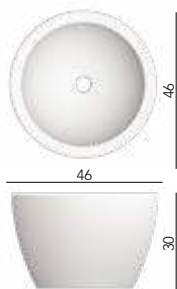

Borchia troppo pieno compresa
Overflow cap included
Anneau trop-plein inclus
Beschlag für Überlaufschutz inklusive
Tachón rebosadero incluido
Перелив входит в комплект

PALLET QUANTITY - 100x120x200h: 28

PALLET QUANTITY - 80x120x200h: 16

BIOKER + 115,00

Art. 8055/R

MATTY TONDO R - Ø46 Cm - 17 Kg - 6,5 L.



Lavabo da appoggio
Lay-on washbasin
Lavabo à poser
Aufsatzwaschbecken
Lavabo de apojo
Раковина умывальника накладная

WHITE

390,00

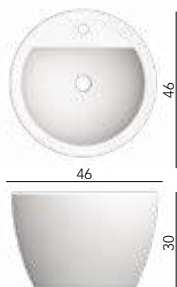

Borchia troppo pieno compresa
Overflow cap included
Anneau trop-plein inclus
Beschlag für Überlaufschutz inklusive
Tachón rebosadero incluido
Перелив входит в комплект

PALLET QUANTITY - 100x120x200h: 28

PALLET QUANTITY - 80x120x200h: 16

BIOKER + 115,00

Art. 8055/A

MATTY TONDO A - Ø46 Cm - 17 Kg - 8 L.



Lavabo da incasso
Built-in washbasin
Lavabo encastré
Einbauwaschbecken
Lavabo de encaje
Раковина умывальника встраиваемая

WHITE

390,00

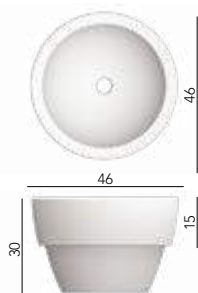

Borchia troppo pieno compresa
Overflow cap included
Anneau trop-plein inclus
Beschlag für Überlaufschutz inklusive
Tachón rebosadero incluido
Перелив входит в комплект

PALLET QUANTITY - 100x120x200h: 28

PALLET QUANTITY - 80x120x200h: 16

BIOKER + 115,00

Art. 8055/A/R

MATTY TONDO A/R - Ø46 Cm - 17 Kg - 6,5 L.

Lavabo da incasso
 Built-in washbasin
 Lavabo encastré
 Einbauwaschbecken
 Lavabo de encaje
 Раковина умывальника встраиваемая

WHITE

390,00



Borchia troppo pieno compresa
 Overflow cap included
 Anneau trop-plein inclus
 Beschlag für Überlaufschutz inklusive
 Tachón rebosadero incluido
 Перелив входит в комплект

PALLET QUANTITY - 100x120x200h: 28

PALLET QUANTITY - 80x120x200h: 16

BIOKER + 115,00

Art. 8056

MATTY OVALE - 64 x 46 Cm - 24 Kg - 9 L.

Lavabo da appoggio
 Lay-on washbasin
 Lavabo à poser
 Aufsatzwaschbecken
 Lavabo de apoyo
 Раковина умывальника накладная

WHITE

390,00



Borchia troppo pieno compresa
 Overflow cap included
 Anneau trop-plein inclus
 Beschlag für Überlaufschutz inklusive
 Tachón rebosadero incluido
 Перелив входит в комплект

PALLET QUANTITY - 100x120x200h: 24

PALLET QUANTITY - 80x120x200h: 11

BIOKER + 115,00

Art. 8056/R

MATTY OVALE R - 64 x 46 Cm - 24 Kg - 8 L.

Lavabo da appoggio
 Lay-on washbasin
 Lavabo à poser
 Aufsatzwaschbecken
 Lavabo de apoyo
 Раковина умывальника накладная

WHITE

390,00



Borchia troppo pieno compresa
 Overflow cap included
 Anneau trop-plein inclus
 Beschlag für Überlaufschutz inklusive
 Tachón rebosadero incluido
 Перелив входит в комплект

PALLET QUANTITY - 100x120x200h: 24

PALLET QUANTITY - 80x120x200h: 11

BIOKER + 115,00

Art. 8056/A

MATTY OVALE A - 64 x 46 Cm - 24 Kg - 9 L.



Lavabo da incasso
Built-in washbasin
Lavabo encastré
Einbauwaschbecken
Lavabo de encaje
Раковина умывальника встраиваемая

WHITE

390,00

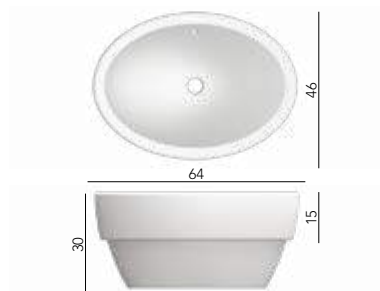

Borchia troppo pieno compresa
Overflow cap included
Anneau trop-plein inclus
Beschlag für Überlaufschutz inklusive
Tachón rebosadero incluido
Перелив входит в комплект

PALLET QUANTITY - 100x120x200h: 24
PALLET QUANTITY - 80x120x200h: 11

BIOKER + 115,00

Art. 8056/A/R

MATTY OVALE A/R - 64 x 46 Cm - 24 Kg - 8 L.



Lavabo da incasso
Built-in washbasin
Lavabo encastré
Einbauwaschbecken
Lavabo de encaje
Раковина умывальника встраиваемая

WHITE

390,00



Borchia troppo pieno compresa
Overflow cap included
Anneau trop-plein inclus
Beschlag für Überlaufschutz inklusive
Tachón rebosadero incluido
Перелив входит в комплект

PALLET QUANTITY - 100x120x200h: 24
PALLET QUANTITY - 80x120x200h: 11

BIOKER + 115,00

Art. 10034

Piletta lavabo da 1"1/4
con troppo pieno integrato
1"1/4 washbasin waste with overflow
Bonde lavabo de 1"1/4 avec trop-plein intégré
Waschbeckenabfluss 1"1/4 mit integriertem Überlaufschutz
Desagüe lavabo de 1"1/4 con rebosadero integrado
Донный клапан для умывальника 1"1/4 с интегрированным переливом

CR ●

200,00

NROP ●

220,00

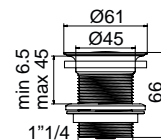

Art. 10010/C

Scarico automatico 1"1/4 click-clack, tappo grande
Automatic pop-waste 1" 1/4 click-clack, big plug
Bonde clic-clac, grand debit
Automatischer ablauf click-clack, crosser stöpsel
Valvula automática 1" 1/4 click-clack, tapón grande
Слив автоматический: клапан 1"1/4, большая пробка

CR ● / NROP ● + WHITE

105,00

ORS ● + WHITE

145,00





KONG 50
Art. 8051



KONG 70
Art. 8052



KONG 90
Art. 8053



KONG 110
Art. 8054



KONG 50R
Art. 8051/R



KONG 70R
Art. 8052/R



KONG 90R
Art. 8053/R



KONG 110R
Art. 8054/R

MATCHING WCS AND BIDETS - WC ET BIDET COMBINABLES
KOMBINIERBARE WCS UND BIDETS - WC BIDÉ COMBINABLES
УНИТАЗЫ БИДЕ КОМБИНИРУЕМЫЕ



P_8

Art. 5520/CL - 50,5 x 36 - CLEAN FLUSH
Art. 5521 - 50,5 x 36



P_11

Art. 5524/CL - 45 x 35 - CLEAN FLUSH
Art. 5525 - 45 x 35



P_9

Art. 5522 - 54,5 x 36
Art. 5522/CL - 54,5 x 36 - CLEAN FLUSH
Art. 5523 - 54,5 x 36



P_10

Art. 5526/CL - 66 x 36 - CLEAN FLUSH
Art. 5527 - 36 x 15 - CISTERN

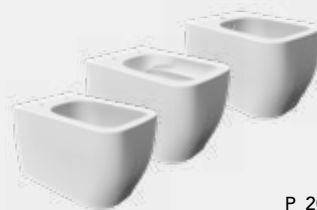

P_20

Art. 5126/TW - 52 x 36 - TWIST
Art. 5126/CL - 52 x 36 - CLEAN FLUSH
Art. 5127 - 52 x 36



P_21

Art. 5138/CL - 55 x 36 - CLEAN FLUSH
Art. 5139 - 55 x 36



P_22

Art. 5140/CL - 66 x 36 - CLEAN FLUSH
Art. 5141 - 35 x 15 - CISTERN



P_48

Art. 5201/TW - 50,5 x 36 - TWIST
Art. 5202 - 50,5 x 36



P_126

Art. 8701 - 50 x 35
Art. 8702 - 50 x 35



P_58

Art. 8812 - 53,5 x 36
Art. 8812/CL - 53,5 x 36 - CLEAN FLUSH
Art. 8813 - 53,5 x 36
Art. 8815 - 40 x 29 - KIDS WC

Art. 8051

KONG 50 - 48 x 39 Cm - 6 Kg - 1 L.



Lavabo da appoggio
Lay-on washbasin
Lavabo à poser
Aufsatzwaschbecken
Lavabo de apoyo
Раковина умывальника накладная

WHITE

470,00

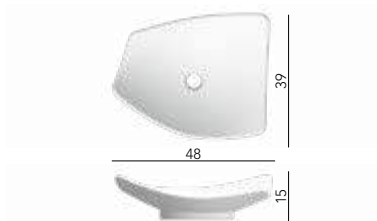

Senza troppo pieno - Consigliata piletta Art. 10034
Without overflow - Waste Art. 10034 recommended
Sans trop-plein - Bonde Art. 10034 conseillée
Ohne überlauf - Abfluss Art. 10034 empfohlen
Sin rebosadero - Recomendado desagüe Art. 10034
Без пробки перелива - Рекомендуется донный клапан арт. 10034

PALLET QUANTITY - 100x120x200h: 56
PALLET QUANTITY - 80x120x200h: 36

BIOKER + 115,00

Art. 8051/R

KONG 50R - 48 x 39 Cm - 6 Kg - 1 L.



Lavabo da appoggio
Lay-on washbasin
Lavabo à poser
Aufsatzwaschbecken
Lavabo de apoyo
Раковина умывальника накладная

WHITE

470,00

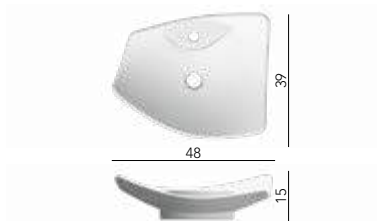

Senza troppo pieno - Consigliata piletta Art. 10034
Without overflow - Waste Art. 10034 recommended
Sans trop-plein - Bonde Art. 10034 conseillée
Ohne überlauf - Abfluss Art. 10034 empfohlen
Sin rebosadero - Recomendado desagüe Art. 10034
Без пробки перелива - Рекомендуется донный клапан арт. 10034

PALLET QUANTITY - 100x120x200h: 56
PALLET QUANTITY - 80x120x200h: 36

BIOKER + 115,00

Art. 8052

KONG 70 - 72 x 37 Cm - 8 Kg - 1,5 L.



Lavabo da appoggio
Lay-on washbasin
Lavabo à poser
Aufsatzwaschbecken
Lavabo de apoyo
Раковина умывальника накладная

WHITE

500,00

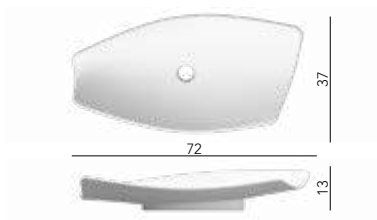

Senza troppo pieno - Consigliata piletta Art. 10034
Without overflow - Waste Art. 10034 recommended
Sans trop-plein - Bonde Art. 10034 conseillée
Ohne überlauf - Abfluss Art. 10034 empfohlen
Sin rebosadero - Recomendado desagüe Art. 10034
Без пробки перелива - Рекомендуется донный клапан арт. 10034

PALLET QUANTITY - 100x120x200h: 36
PALLET QUANTITY - 80x120x200h: 34

BIOKER + 115,00

Art. 8052/R

KONG 70R - 72 x 37 Cm - 8 Kg - 1,5 L.



Lavabo da appoggio
Lay-on washbasin
Lavabo à poser
Aufsatzwaschbecken
Lavabo de apoyo
Раковина умывальника накладная

WHITE

500,00



Senza troppo pieno - Consigliata piletta Art. 10034
Without overflow - Waste Art. 10034 recommended
Sans trop-plein - Bonde Art. 10034 conseillée
Ohne überlauf - Abfluss Art. 10034 empfohlen
Sin rebosadero - Recomendado desagüe Art. 10034
Без пробки перелива - Рекомендуется донный клапан арт. 10034

PALLET QUANTITY - 100x120x200h: 36

PALLET QUANTITY - 80x120x200h: 34

BIOKER + 115,00

Art. 8053

KONG 90 - 90 x 38 Cm - 11 Kg - 2 L.



Lavabo da appoggio
Lay-on washbasin
Lavabo à poser
Aufsatzwaschbecken
Lavabo de apoyo
Раковина умывальника накладная

WHITE

560,00



Senza troppo pieno - Consigliata piletta Art. 10034
Without overflow - Waste Art. 10034 recommended
Sans trop-plein - Bonde Art. 10034 conseillée
Ohne überlauf - Abfluss Art. 10034 empfohlen
Sin rebosadero - Recomendado desagüe Art. 10034
Без пробки перелива - Рекомендуется донный клапан арт. 10034

PALLET QUANTITY - 100x120x200h: 26

PALLET QUANTITY - 80x120x200h: 16

BIOKER + 115,00

Art. 8053/R

KONG 90R - 90 x 38 Cm - 11 Kg - 2 L.



Lavabo da appoggio
Lay-on washbasin
Lavabo à poser
Aufsatzwaschbecken
Lavabo de apoyo
Раковина умывальника накладная

WHITE

560,00



Senza troppo pieno - Consigliata piletta Art. 10034
Without overflow - Waste Art. 10034 recommended
Sans trop-plein - Bonde Art. 10034 conseillée
Ohne überlauf - Abfluss Art. 10034 empfohlen
Sin rebosadero - Recomendado desagüe Art. 10034
Без пробки перелива - Рекомендуется донный клапан арт. 10034

PALLET QUANTITY - 100x120x200h: 26

PALLET QUANTITY - 80x120x200h: 16

BIOKER + 115,00

Art. 8054

KONG 110 - 109 x 42 Cm - 15 Kg - 2,5 L.



Lavabo da appoggio
Lay-on washbasin
Lavabo à poser
Aufsatzwaschbecken
Lavabo de apoyo
Раковина умывальника накладная

WHITE

670,00

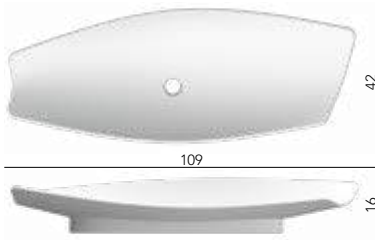

Senza troppo pieno - Consigliata piletta Art. 10034
Without overflow - Waste Art. 10034 recommended
Sans trop-plein - Bonde Art. 10034 conseillée
Ohne überlauf - Abfluss Art. 10034 empfohlen
Sin rebosadero - Recomendado desagüe Art. 10034
Без пробки перелива - Рекомендуется донный клапан арт. 10034

PALLET QUANTITY - 100x120x200h: 17
PALLET QUANTITY - 80x120x200h: 13

BIOKER + 115,00

Art. 8054/R

KONG 110R - 109 x 42 Cm - 15 Kg - 2,5 L.



Lavabo da appoggio
Lay-on washbasin
Lavabo à poser
Aufsatzwaschbecken
Lavabo de apoyo
Раковина умывальника накладная

WHITE

670,00



Senza troppo pieno - Consigliata piletta Art. 10034
Without overflow - Waste Art. 10034 recommended
Sans trop-plein - Bonde Art. 10034 conseillée
Ohne überlauf - Abfluss Art. 10034 empfohlen
Sin rebosadero - Recomendado desagüe Art. 10034
Без пробки перелива - Рекомендуется донный клапан арт. 10034

PALLET QUANTITY - 100x120x200h: 17
PALLET QUANTITY - 80x120x200h: 13

BIOKER + 115,00

Art. 10034



Piletta lavabo da 1"1/4
con troppo pieno integrato
1"1/4 washbasin waste with overflow
Bonde lavabo de 1"1/4 avec trop-plein intégré
Waschbeckenabfluss 1"1/4 mit integriertem Überlaufschutz
Desagüe lavabo de 1"1/4 con rebosadero integrado
Донный клапан для умывальника 1"1/4 с интегрированным переливом

CR ●

200,00

NROP ●

220,00

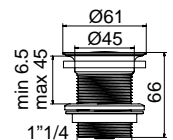

Art. 10010/C



Scarico automatico 1"1/4 click-clack, tappo grande
Automatic pop-waste 1" 1/4 click-clack, big plug
Bonde clic-clac, grand debit
Automatischer ablauf click-clack, crosser stöpsel
Valvula automática 1" 1/4 click-clack, tapón grande
Слив автоматический: клапан 1"1/4, большая пробка

CR ● / **NROP** ● + **WHITE** **105,00**

ORS ● + **WHITE** **145,00**



TSUNAMI 70
Art. 8039



TSUNAMI 70R
Art. 8039/R



TSUNAMI 90
Art. 8038



TSUNAMI 90R
Art. 8038/R

WC BIDET ABBINABILI

MATCHING WCS AND BIDETS - WC ET BIDET COMBINABLES
KOMBINIERBARE WCS UND BIDETS - WC BIDÉ COMBINABLES
УНИТАЗЫ БИДЕ КОМБИНИРУЕМЫЕ



P_8

Art. 5520/CL - 50,5 x 36 - CLEAN FLUSH
Art. 5521 - 50,5 x 36



P_11

Art. 5524/CL - 45 x 35 - CLEAN FLUSH
Art. 5525 - 45 x 35



P_9

Art. 5522 - 54,5 x 36
Art. 5522/CL - 54,5 x 36 - CLEAN FLUSH
Art. 5523 - 54,5 x 36



P_10

Art. 5526/CL - 66 x 36 - CLEAN FLUSH
Art. 5527 - 36 x 15 - CISTERN

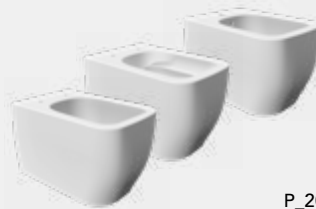

P_20

Art. 5126/TW - 52 x 36 - TWIST
Art. 5126/CL - 52 x 36 - CLEAN FLUSH
Art. 5127 - 52 x 36



P_21

Art. 5138/CL - 55 x 36 - CLEAN FLUSH
Art. 5139 - 55 x 36



P_22

Art. 5140/CL - 66 x 36 - CLEAN FLUSH
Art. 5141 - 35 x 15 - CISTERN



P_48

Art. 5201/TW - 50,5 x 36 - TWIST
Art. 5202 - 50,5 x 36



P_126

Art. 8701 - 50 x 35
Art. 8702 - 50 x 35



P_58

Art. 8812 - 53,5 x 36
Art. 8812/CL - 53,5 x 36 - CLEAN FLUSH
Art. 8813 - 53,5 x 36
Art. 8815 - 40 x 29 - KIDS WC

Art. 8039

- MODELLO REGISTRATO -
- REGISTERED MODEL -



TSUNAMI 70 - 70 x 45,5 Cm - 16 Kg - 3 L.

Lavabo da appoggio o sospeso

Lay-on or wall-mounted washbasin

Lavabo à poser ou suspendu

Aufsatz-oder Hängewaschbecken

Lavabo de apoyo o suspendido

Раковина умывальника накладная или подвесная

WHITE

620,00

#

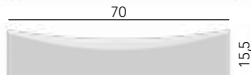

Fissaggi a muro compresi - Senza troppo pieno - Consigliata piletta Art. 10034

Wall attachments included - Without overflow - Waste Art. 10034 recommended

Fixations murales incluses - Sans trop-plein - Bonde Art. 10034 conseillée

Wandbefestigungen inklusive - Ohne überlauf - Abfluss Art. 10034 empfohlen

Fijación pared incluida - Sin rebosadero - Recomendado desagüe Art. 10034

Настенные крепления входят в комплект - Без пробки перелива - Рекомендуется донный клапан арт. 10034

PALLET QUANTITY - 100x120x200h: 30

PALLET QUANTITY - 80x120x200h: 28

BIOKER + 115,00

Art. 8038

- MODELLO REGISTRATO -
- REGISTERED MODEL -

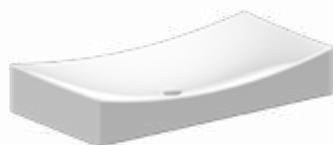

TSUNAMI 90 - 90 x 45,5 Cm - 22 Kg - 3,5 L.

Lavabo da appoggio o sospeso

Lay-on or wall-mounted washbasin

Lavabo à poser ou suspendu

Aufsatz-oder Hängewaschbecken

Lavabo de apoyo o suspendido

Раковина умывальника накладная или подвесная

WHITE

785,00

#

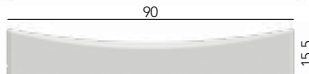

Fissaggi a muro compresi - Senza troppo pieno - Consigliata piletta Art. 10034

Wall attachments included - Without overflow - Waste Art. 10034 recommended

Fixations murales incluses - Sans trop-plein - Bonde Art. 10034 conseillée

Wandbefestigungen inklusive - Ohne überlauf - Abfluss Art. 10034 empfohlen

Fijación pared incluida - Sin rebosadero - Recomendado desagüe Art. 10034

Настенные крепления входят в комплект - Без пробки перелива - Рекомендуется донный клапан арт. 10034

PALLET QUANTITY - 100x120x200h: 20

PALLET QUANTITY - 80x120x200h: 13

BIOKER + 115,00

Art. 8039/R

- MODELLO REGISTRATO -
- REGISTERED MODEL -



TSUNAMI 70R - 70 x 45,5 Cm - 16 Kg - 3 L.

Lavabo da appoggio o sospeso

Lay-on or wall-mounted washbasin

Lavabo à poser ou suspendu

Aufsatz-oder Hängewaschbecken

Lavabo de apoyo o suspendido

Раковина умывальника накладная или подвесная

WHITE

620,00

#

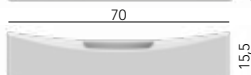

Fissaggi a muro compresi - Senza troppo pieno - Consigliata piletta Art. 10034

Wall attachments included - Without overflow - Waste Art. 10034 recommended

Fixations murales incluses - Sans trop-plein - Bonde Art. 10034 conseillée

Wandbefestigungen inklusive - Ohne überlauf - Abfluss Art. 10034 empfohlen

Fijación pared incluida - Sin rebosadero - Recomendado desagüe Art. 10034

Настенные крепления входят в комплект - Без пробки перелива - Рекомендуется донный клапан арт. 10034

PALLET QUANTITY - 100x120x200h: 30

PALLET QUANTITY - 80x120x200h: 28

BIOKER + 115,00

Art. 8038/R

- MODELLO REGISTRATO -
- REGISTERED MODEL -

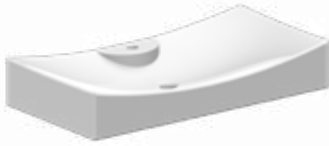

TSUNAMI 90R - 90 x 45,5 Cm - 22 Kg - 3,5 L.

Lavabo da appoggio o sospeso

Lay-on or wall-mounted washbasin

Lavabo à poser ou suspendu

Aufsatz-oder Hängewaschbecken

Lavabo de apoyo o suspendido

Раковина умывальника накладная или подвесная

WHITE

785,00

#

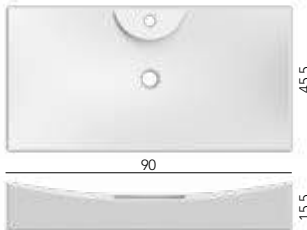

Fissaggi a muro compresi - Senza troppo pieno - Consigliata piletta Art. 10034

Wall attachments included - Without overflow - Waste Art. 10034 recommended

Fixations murales incluses - Sans trop-plein - Bonde Art. 10034 conseillée

Wandbefestigungen inklusive - Ohne überlauf - Abfluss Art. 10034 empfohlen

Fijación pared incluida - Sin rebosadero - Recomendado desagüe Art. 10034

Настенные крепления входят в комплект - Без пробки перелива - Рекомендуется донный клапан арт. 10034

PALLET QUANTITY - 100x120x200h: 20

PALLET QUANTITY - 80x120x200h: 13

BIOKER + 115,00

Art. 10034



Piletta lavabo da 1"1/4

con troppo pieno integrato

1"1/4 washbasin waste with overflow

Bonde lavabo de 1"1/4 avec trop-plein intégré

Waschbeckenabfluss 1"1/4 mit integriertem Überlaufschutz

Desagüe lavabo de 1"1/4 con rebosadero integrado

Донный клапан для умывальника 1"1/4 с интегрированным переливом

CR

200,00

NROP

220,00

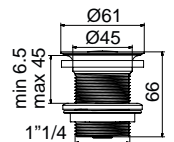

Art. 10010/C



Scarico automatico 1"1/4 click-clack, tappo grande

Automatic pop-waste 1" 1/4 click-clack, big plug

Bonde clic-clac, grand debit

Automatischer ablauf click-clack, crosser stöpsel

Valvula automática 1" 1/4 click-clack, tapón grande

Слив автоматический: клапан 1"1/4, большая пробка

CR / NROP + WHITE 105,00

ORS + WHITE

145,00

WC BIDET ABBINABILI

MATCHING WCS AND BIDETS - WC ET BIDET COMBINABLES
 KOMBINIERBARE WCS UND BIDETS - WC BIDÉ COMBINABLES
 УНИТАЗЫ БИДЕ КОМБИНИРУЕМЫЕ



SQUARE 50B
Art. 8025/B



SQUARE 60B
Art. 8007/B



SQUARE 50D
Art. 8025/D



SQUARE 60D
Art. 8007/D



SQUARE 50A
Art. 8025/A



SQUARE 60A
Art. 8007/A



SQUARE E
Art. 8007/E



P_8

Art. 5520/CL - 50,5 x 36 - CLEAN FLUSH
 Art. 5521 - 50,5 x 36



P_11

Art. 5524/CL - 45 x 35 - CLEAN FLUSH
 Art. 5525 - 45 x 35



P_9

Art. 5522 - 54,5 x 36
 Art. 5522/CL - 54,5 x 36 - CLEAN FLUSH
 Art. 5523 - 54,5 x 36



P_10

Art. 5526/CL - 66 x 36 - CLEAN FLUSH
 Art. 5527 - 36 x 15 - CISTERN

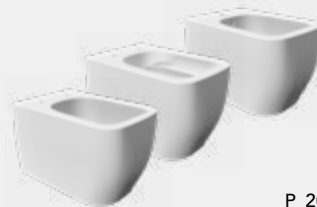

P_20

Art. 5126/TW - 52 x 36 - TWIST
 Art. 5126/CL - 52 x 36 - CLEAN FLUSH
 Art. 5127 - 52 x 36



P_21

Art. 5138/CL - 55 x 36 - CLEAN FLUSH
 Art. 5139 - 55 x 36



P_22

Art. 5140/CL - 66 x 36 - CLEAN FLUSH
 Art. 5141 - 35 x 15 - CISTERN



P_48

Art. 5201/TW - 50,5 x 36 - TWIST
 Art. 5202 - 50,5 x 36



P_126

Art. 8701 - 50 x 35
 Art. 8702 - 50 x 35



P_58

Art. 8812 - 53,5 x 36
 Art. 8812/CL - 53,5 x 36 - CLEAN FLUSH
 Art. 8813 - 53,5 x 36
 Art. 8815 - 40 x 29 - KIDS WC

Art. 8025/B

SQUARE 50B - 51 x 46 - 17 Kg - 3 L.



Lavabo da appoggio o sospeso

Lay-on or wall-mounted washbasin

Lavabo à poser ou suspendu

Aufsatz-oder Hängewaschbecken

Lavabo de apoyo o suspendido

Раковина умывальника накладная или подвесная

WHITE

370,00

#



Fissaggi a muro compresi - Borchia troppo pieno compresa

Wall attachments included - Overflow cap included

Fixations murales incluses - Anneau trop-plein inclus

Wandbefestigungen inklusive - Beschlag für Überlaufschutz inklusive

Fijación pared incluida - Tachón rebosadero incluido

Настенные крепления входят в комплект - Перелив входит в комплект

PALLET QUANTITY - 100x120x200h: 50

PALLET QUANTITY - 80x120x200h: 28

BIOKER + 115,00

Art. 8025/D

SQUARE 50D - 51 x 46 Cm - 17 Kg - 3 L.



Lavabo da semincasso

Semi built-in washbasin

Lavabo semi encastré

Vorbauwaschbecken

Lavabo de semiencaje

Раковина умывальника полувстраиваемая

WHITE

370,00

#

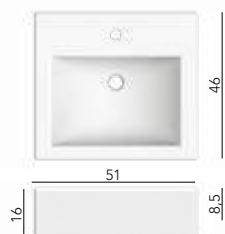

Borchia troppo pieno compresa

Overflow cap included

Anneau trop-plein inclus

Beschlag für Überlaufschutz inklusive

Tachón rebosadero incluido

Перелив входит в комплект

PALLET QUANTITY - 100x120x200h: 50

PALLET QUANTITY - 80x120x200h: 28

BIOKER + 115,00

Art. 8025/A

SQUARE 50A - 51 x 46 Cm - 17 Kg - 3 L.



Lavabo da incasso

Built-in washbasin

Lavabo encastré

Einbauwaschbecken

Lavabo de encaje

Раковина умывальника встраиваемая

WHITE

370,00

#

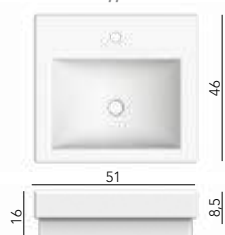

Borchia troppo pieno compresa

Overflow cap included

Anneau trop-plein inclus

Beschlag für Überlaufschutz inklusive

Tachón rebosadero incluido

Перелив входит в комплект

PALLET QUANTITY - 100x120x200h: 50

PALLET QUANTITY - 80x120x200h: 28

BIOKER + 115,00

Art. 8007/B

SQUARE 60B - 60 x 51 - 20 Kg - 4 L.



Lavabo da appoggio o sospeso

Lay-on or wall-mounted washbasin

Lavabo à poser ou suspendu

Aufsatz-oder Hängewaschbecken

Lavabo de apoyo o suspendido

Раковина умывальника накладная или подвесная

WHITE

370,00

#

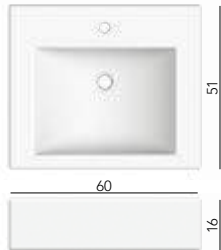

Fissaggi a muro compresi - Borchia troppo pieno compresa

Wall attachments included - Overflow cap included

Fixations murales incluses - Anneau trop-plein inclus

Wandbefestigungen inklusive - Beschlag für Überlaufschutz inklusive

Fijación pared incluida - Tachón rebosadero incluido

Настенные крепления входят в комплект - Перелив входит в комплект

PALLET QUANTITY - 100x120x200h: 34

PALLET QUANTITY - 80x120x200h: 26

BIOKER + 115,00

Art. 8007/D

SQUARE 60D - 60 x 51 - 20 Kg - 4 L.



Lavabo da semincasso

Semi built-in washbasin

Lavabo semi encastré

Vorbauwaschbecken

Lavabo de semiencaje

Раковина умывальника полувстраиваемая

WHITE

370,00

#

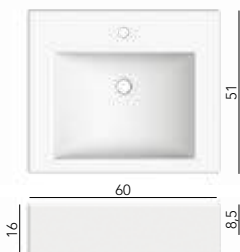

Borchia troppo pieno compresa

Overflow cap included

Anneau trop-plein inclus

Beschlag für Überlaufschutz inklusive

Tachón rebosadero incluido

Перелив входит в комплект

PALLET QUANTITY - 100x120x200h: 34

PALLET QUANTITY - 80x120x200h: 26

BIOKER + 115,00

Art. 8007/A

SQUARE 60A - 60 x 51 Cm - 20 Kg - 4 L.



Lavabo da incasso

Built-in washbasin

Lavabo encastré

Einbauwaschbecken

Lavabo de encaje

Раковина умывальника встраиваемая

WHITE

370,00

#

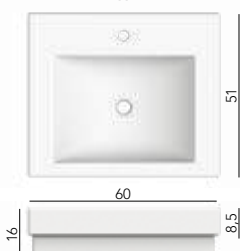

Borchia troppo pieno compresa

Overflow cap included

Anneau trop-plein inclus

Beschlag für Überlaufschutz inklusive

Tachón rebosadero incluido

Перелив входит в комплект

PALLET QUANTITY - 100x120x200h: 34

PALLET QUANTITY - 80x120x200h: 26

BIOKER + 115,00

Art. 8007/E

SQUARE E - 47,5 x 47,5 Cm - 14 Kg - 2,5 L.



Lavabo da appoggio o sospeso

Lay-on or wall-mounted washbasin

Lavabo à poser ou suspendu

Aufsatz-oder Hängewaschbecken

Lavabo de apoyo o suspendido

Раковина умывальника накладная или подвесная

WHITE

370,00

#

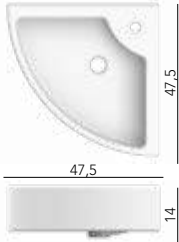

Fissaggi a muro compresi - Borchia troppo pieno compresa

Wall attachments included - Overflow cap included

Fixations murales incluses - Anneau trop-plein inclus

Wandbefestigungen inklusive - Beschlag für Überlaufschutz inklusive

Fijación pared incluida - Tachón rebosadero incluido

Настенные крепления входят в комплект - Перелив входит в комплект

PALLET QUANTITY - 100x120x200h: 50

PALLET QUANTITY - 80x120x200h: 28

BIOKER + 115,00

Art. 10034



Piletta lavabo da 1"1/4

con troppo pieno integrato

1"1/4 washbasin waste with overflow

Bonde lavabo de 1"1/4 avec trop-plein intégré

Waschbeckenabfluss 1"1/4 mit integriertem Überlaufschutz

Desagüe lavabo de 1"1/4 con rebosadero integrado

Донный клапан для умывальника 1"1/4 с интегрированным переливом

CR

200,00

NROP

220,00

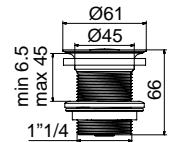

Art. 10010/C



Scarico automatico 1"1/4 click-clack, tappo grande

Automatic pop-waste 1" 1/4 click-clack, big plug

Bonde clic-clac, grand debit

Automatischer ablauf click-clack, crosser stöpsel

Valvula automática 1" 1/4 click-clack, tapón grande

Слив автоматический: клапан 1"1/4, большая пробка

CR / NROP + WHITE **105,00**

ORS + WHITE

145,00

MATCHING WCS AND BIDETS - WC ET BIDET COMBINABLES
 KOMBINIERBARE WCS UND BIDETS - WC BIDÉ COMBINABLES
 УНИТАЗЫ БИДЕ КОМБИНИРУЕМЫЕ



ARCO 60
 Art. 1001



ARCO 80
 Art. 1002



P_8

Art. 5520/CL - 50,5 x 36 - CLEAN FLUSH
 Art. 5521 - 50,5 x 36



P_11

Art. 5524/CL - 45 x 35 - CLEAN FLUSH
 Art. 5525 - 45 x 35



P_9

Art. 5522 - 54,5 x 36
 Art. 5522/CL - 54,5 x 36 - CLEAN FLUSH
 Art. 5523 - 54,5 x 36



P_10

Art. 5526/CL - 66 x 36 - CLEAN FLUSH
 Art. 5527 - 36 x 15 - CISTERN

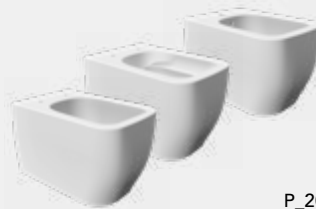

P_20

Art. 5126/TW - 52 x 36 - TWIST
 Art. 5126/CL - 52 x 36 - CLEAN FLUSH
 Art. 5127 - 52 x 36



P_21

Art. 5138/CL - 55 x 36 - CLEAN FLUSH
 Art. 5139 - 55 x 36



P_22

Art. 5140/CL - 66 x 36 - CLEAN FLUSH
 Art. 5141 - 35 x 15 - CISTERN



P_48

Art. 5201/TW - 50,5 x 36 - TWIST
 Art. 5202 - 50,5 x 36



P_126

Art. 8701 - 50 x 35
 Art. 8702 - 50 x 35



P_58

Art. 8812 - 53,5 x 36
 Art. 8812/CL - 53,5 x 36 - CLEAN FLUSH
 Art. 8813 - 53,5 x 36
 Art. 8815 - 40 x 29 - KIDS WC

Art. 1001

ARCO 60 - 60 x 46,5 Cm - 18 Kg - 17 L.



Lavabo da incasso
Built-in washbasin
Lavabo encastré
Einbauwaschbecken
Lavabo de encaje
Раковина умывальника встраиваемая

WHITE

575,00



Borchia troppo pieno compresa
Overflow cap included
Anneau trop-plein inclus
Beschlag für Überlaufschutz inklusive
Tachón rebosadero incluido
Перелив входит в комплект

PALLET QUANTITY - 100x120x200h: 24
PALLET QUANTITY - 80x120x200h: 11

BIOKER + 115,00

Art. 1002

ARCO 80 - 80 x 46,5 Cm - 20 Kg - 23 L.



Lavabo da incasso
Built-in washbasin
Lavabo encastré
Einbauwaschbecken
Lavabo de encaje
Раковина умывальника встраиваемая

WHITE

650,00



Borchia troppo pieno compresa
Overflow cap included
Anneau trop-plein inclus
Beschlag für Überlaufschutz inklusive
Tachón rebosadero incluido
Перелив входит в комплект

PALLET QUANTITY - 100x120x200h: 12
PALLET QUANTITY - 80x120x200h: 10

BIOKER + 115,00

Art. 10034



Piletta lavabo da 1"1/4
con troppo pieno integrato
1"1/4 washbasin waste with overflow
Bonde lavabo de 1"1/4 avec trop-plein intégré
Waschbeckenabfluss 1"1/4 mit integriertem Überlaufschutz
Desagüe lavabo de 1"1/4 con rebosadero integrado
Донный клапан для умывальника 1"1/4 с интегрированным переливом

CR ●

200,00

NROP ●

220,00

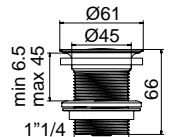

Art. 10010/C



Scarico automatico 1"1/4 click-clack, tappo grande
Automatic pop-waste 1" 1/4 click-clack, big plug
Bonde clic-clac, grand debit
Automatischer ablauf click-clack, crosser stöpsel
Valvula automática 1" 1/4 click-clack, tapón grande
Слив автоматический: клапан 1"1/4, большая пробка

CR ● / **NROP** ● + **WHITE** **105,00**

ORS ● + **WHITE**

145,00



ETRA 61x47
Art. 5210



ETRA 82x47
Art. 5211



ETRA 82x47
Art. 5212



CONSOLE

MATCHING WCS AND BIDETS - WC ET BIDET COMBINABILI
KOMBINIERBARE WCS UND BIDETS - WC BIDÉ COMBINABLES
УНИТАЗЫ БИДЕ КОМБИНИРУЕМЫЕ



P_8

Art. 5520/CL - 50,5 x 36 - CLEAN FLUSH
Art. 5521 - 50,5 x 36



P_11

Art. 5524/CL - 45 x 35 - CLEAN FLUSH
Art. 5525 - 45 x 35



P_9

Art. 5522 - 54,5 x 36
Art. 5522/CL - 54,5 x 36 - CLEAN FLUSH
Art. 5523 - 54,5 x 36



P_10

Art. 5526/CL - 66 x 36 - CLEAN FLUSH
Art. 5527 - 36 x 15 - CISTERN

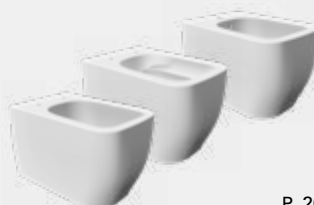

P_20

Art. 5126/TW - 52 x 36 - TWIST
Art. 5126/CL - 52 x 36 - CLEAN FLUSH
Art. 5127 - 52 x 36



P_21

Art. 5138/CL - 55 x 36 - CLEAN FLUSH
Art. 5139 - 55 x 36



P_22

Art. 5140/CL - 66 x 36 - CLEAN FLUSH
Art. 5141 - 35 x 15 - CISTERN



P_48

Art. 5201/TW - 50,5 x 36 - TWIST
Art. 5202 - 50,5 x 36



P_126

Art. 8701 - 50 x 35
Art. 8702 - 50 x 35



P_58

Art. 8812 - 53,5 x 36
Art. 8812/CL - 53,5 x 36 - CLEAN FLUSH
Art. 8813 - 53,5 x 36
Art. 8815 - 40 x 29 - KIDS WC



Art. 5210

ETRA 61 x 47 - 61,5 x 47 Cm - 13,6 Kg - 2,5 L.



#



61,5

47



13,5

Lavabo sospeso

Wall-mounted washbasin

Lavabo suspendu

Hängewaschbecken

Lavabo suspendido

Раковина умывальника подвесна

WHITE

390,00

Fissaggi a muro compresi - Borchia troppo pieno compresa

Wall attachments included - Overflow cap included

Fixations murales incluses - Anneau trop-plein inclus

Wandbefestigungen inklusive - Beschlag für Überlaufschutz inklusive

Fijación pared incluida - Tachón rebosadero incluido

Настенные крепления входят в комплект - Перелив входит в комплект

PALLET QUANTITY - 100x120x200h: 40

PALLET QUANTITY - 80x120x200h: 28

BIOKER + 115,00

Art. 5211

ETRA 82 x 47 SHELF DX - 82,5 x 47 Cm - 18,6 Kg - 3,5 L.



#



82,5

47



13,5

Lavabo sospeso

Wall-mounted washbasin

Lavabo suspendu

Hängewaschbecken

Lavabo suspendido

Раковина умывальника подвесна

WHITE

590,00

Fissaggi a muro compresi - Borchia troppo pieno compresa

Wall attachments included - Overflow cap included

Fixations murales incluses - Anneau trop-plein inclus

Wandbefestigungen inklusive - Beschlag für Überlaufschutz inklusive

Fijación pared incluida - Tachón rebosadero incluido

Настенные крепления входят в комплект - Перелив входит в комплект

PALLET QUANTITY - 100x120x200h: 28

PALLET QUANTITY - 80x120x200h: 25

BIOKER + 115,00

Art. 5212

ETRA 82 x 47 SHELF SX - 82,5 x 47 Cm - 18,6 Kg - 3,5 L.



#



82,5

47



13,5

Lavabo sospeso

Wall-mounted washbasin

Lavabo suspendu

Hängewaschbecken

Lavabo suspendido

Раковина умывальника подвесна

WHITE

590,00

Fissaggi a muro compresi - Borchia troppo pieno compresa

Wall attachments included - Overflow cap included

Fixations murales incluses - Anneau trop-plein inclus

Wandbefestigungen inklusive - Beschlag für Überlaufschutz inklusive

Fijación pared incluida - Tachón rebosadero incluido

Настенные крепления входят в комплект - Перелив входит в комплект

PALLET QUANTITY - 100x120x200h: 28

PALLET QUANTITY - 80x120x200h: 25

BIOKER + 115,00

CONSOLE FOR WASHBASIN



Console per lavabo

Console for washbasin

Console pour lavabo

Konsole für waschbecken

Consolle para lavabo

Подставка под раковину умывальника

Art. 10066

Per - For - Pour - Für - Para - Для: Art.: 5210

CR

650,00

Art. 10067

Per - For - Pour - Für - Para - Для: Art.: 5211 / 5212

CR

650,00

WC BIDET ABBINABILI

MATCHING WCS AND BIDETS - WC ET BIDET COMBINABLES
 KOMBINIERBARE WCS UND BIDETS - WC BIDÉ COMBINABLES
 УНИТАЗЫ БИДЕ КОМБИНИРУЕМЫЕ



SEVENTY 41
 Art. 8093



SEVENTY 41B
 Art. 8093/B



SEVENTY 56
 Art. 8094



P_8
 Art. 5520/CL - 50,5 x 36 - CLEAN FLUSH
 Art. 5521 - 50,5 x 36



P_11
 Art. 5524/CL - 45 x 35 - CLEAN FLUSH
 Art. 5525 - 45 x 35



P_9
 Art. 5522 - 54,5 x 36
 Art. 5522/CL - 54,5 x 36 - CLEAN FLUSH
 Art. 5523 - 54,5 x 36



P_10
 Art. 5526/CL - 66 x 36 - CLEAN FLUSH
 Art. 5527 - 36 x 15 - CISTERN

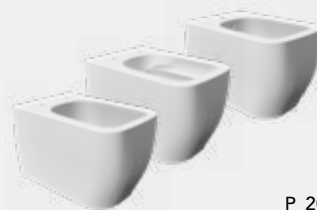

P_20
 Art. 5126/TW - 52 x 36 - TWIST
 Art. 5126/CL - 52 x 36 - CLEAN FLUSH
 Art. 5127 - 52 x 36



P_21
 Art. 5138/CL - 55 x 36 - CLEAN FLUSH
 Art. 5139 - 55 x 36



P_22
 Art. 5140/CL - 66 x 36 - CLEAN FLUSH
 Art. 5141 - 35 x 15 - CISTERN



P_48
 Art. 5201/TW - 50,5 x 36 - TWIST
 Art. 5202 - 50,5 x 36



P_126
 Art. 8701 - 50 x 35
 Art. 8702 - 50 x 35



P_58
 Art. 8812 - 53,5 x 36
 Art. 8812/CL - 53,5 x 36 - CLEAN FLUSH
 Art. 8813 - 53,5 x 36
 Art. 8815 - 40 x 29 - KIDS WC

Art. 8093

SEVENTY 41 - 41 x 22 Cm - 7 Kg - 1,5 L.



Lavabo da appoggio
Lay-on washbasin
Lavabo à poser
Aufsatzwaschbecken
Lavabo de apoyo
Раковина умывальника накладная

WHITE

320,00

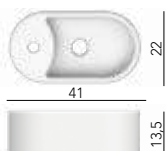

Borchia troppo pieno compresa
Overflow cap included
Anneau trop-plein inclus
Beschlag für Überlaufschutz inklusive
Tachón rebosadero incluido
Перелив входит в комплект

PALLET QUANTITY - 100x120x200h: 98

PALLET QUANTITY - 80x120x200h: 66

BIOKER + 115,00

Art. 8094

SEVENTY 56 - 55 x 30 Cm - 12 Kg - 3 L.



Lavabo da appoggio
Lay-on washbasin
Lavabo à poser
Aufsatzwaschbecken
Lavabo de apoyo
Раковина умывальника накладная

WHITE

390,00

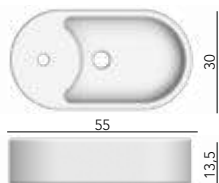

Borchia troppo pieno compresa
Overflow cap included
Anneau trop-plein inclus
Beschlag für Überlaufschutz inklusive
Tachón rebosadero incluido
Перелив входит в комплект

PALLET QUANTITY - 100x120x200h: 60

PALLET QUANTITY - 80x120x200h: 50

BIOKER + 115,00

Art. 8093/B

SEVENTY 41B - 41 x 22 Cm - 7 Kg - 1,5 L.



Lavabo sospeso
Wall-mounted washbasin
Lavabo suspendu
Hängewaschbecken
Lavabo suspendido
Раковина умывальника подвесная

WHITE

320,00

#

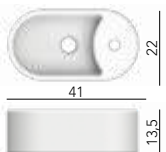

Fissaggi a muro compresi - Borchia troppo pieno compresa
Wall attachments included - Overflow cap included
Fixations murales incluses - Anneau trop-plein inclus
Wandbefestigungen inklusive - Beschlag für Überlaufschutz inklusive
Fijación pared incluida - Tachón rebosadero incluido
Настенные крепления входят в комплект - Перелив входит в комплект

PALLET QUANTITY - 100x120x200h: 98

PALLET QUANTITY - 80x120x200h: 66

BIOKER + 115,00



NEXT 40A
Art. 8047/A



NEXT 40
Art. 8306



NEXT 60
Art. 8307



NEXT 40B
Art. 8047/B



NEXT 40D
Art. 8047/D



NEXT 60B
Art. 8308



NEXT 80D
Art. 8047/D-80

MATCHING WCS AND BIDETS - WC ET BIDET COMBINABLES
KOMBINIERBARE WCS UND BIDETS - WC BIDÉ COMBINABLES
УНИТАЗЫ БИДЕ КОМБИНИРУЕМЫЕ



P_8
Art. 5520/CL - 50,5 x 36 - CLEAN FLUSH
Art. 5521 - 50,5 x 36



P_11
Art. 5524/CL - 45 x 35 - CLEAN FLUSH
Art. 5525 - 45 x 35



P_9
Art. 5522 - 54,5 x 36
Art. 5522/CL - 54,5 x 36 - CLEAN FLUSH
Art. 5523 - 54,5 x 36



P_10
Art. 5526/CL - 66 x 36 - CLEAN FLUSH
Art. 5527 - 36 x 15 - CISTERN

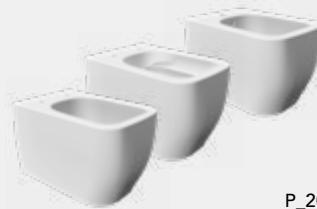

P_20
Art. 5126/TW - 52 x 36 - TWIST
Art. 5126/CL - 52 x 36 - CLEAN FLUSH
Art. 5127 - 52 x 36



P_21
Art. 5138/CL - 55 x 36 - CLEAN FLUSH
Art. 5139 - 55 x 36



P_22
Art. 5140/CL - 66 x 36 - CLEAN FLUSH
Art. 5141 - 35 x 15 - CISTERN



P_48
Art. 5201/TW - 50,5 x 36 - TWIST
Art. 5202 - 50,5 x 36



P_126
Art. 8701 - 50 x 35
Art. 8702 - 50 x 35



P_58
Art. 8812 - 53,5 x 36
Art. 8812/CL - 53,5 x 36 - CLEAN FLUSH
Art. 8813 - 53,5 x 36
Art. 8815 - 40 x 29 - KIDS WC

Art. 8047/A

NEXT 40A - 41 x 41 Cm - 12 Kg - 6 L.

WHITE

330,00



Lavabo da incasso
Built-in washbasin
Lavabo encastré
Einbauwaschbecken
Lavabo de encaje
Раковина умывальника встраиваемая

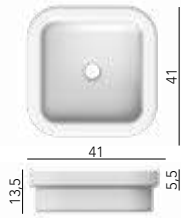

Senza troppo pieno - Consigliata piletta Art. 10034
Without overflow - Waste Art. 10034 recommended
Sans trop-plein - Bonde Art. 10034 conseillée
Ohne überlauf - Abfluss Art. 10034 empfohlen
Sin rebosadero - Recomendado desagüe Art. 10034
Без пробки перелива - Рекомендуется донный клапан арт. 10034

PALLET QUANTITY - 100x120x200h: 50

PALLET QUANTITY - 80x120x200h: 36

BIOKER + 115,00

Art. 8306

NEXT 40 - 41 x 41 Cm - 12 Kg - 6 L.

WHITE

330,00



Lavabo da appoggio
Lay-on washbasin
Lavabo à poser
Aufsatzwaschbecken
Lavabo de apoio
Раковина умывальника накладная

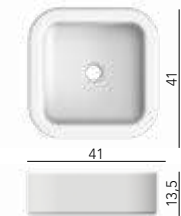

Senza troppo pieno - Consigliata piletta Art. 10034
Without overflow - Waste Art. 10034 recommended
Sans trop-plein - Bonde Art. 10034 conseillée
Ohne überlauf - Abfluss Art. 10034 empfohlen
Sin rebosadero - Recomendado desagüe Art. 10034
Без пробки перелива - Рекомендуется донный клапан арт. 10034

PALLET QUANTITY - 100x120x200h: 50

PALLET QUANTITY - 80x120x200h: 36

BIOKER + 115,00

Art. 8307

NEXT 60 - 60 x 41 Cm - 16 Kg - 8 L.

WHITE

430,00



Lavabo da appoggio
Lay-on washbasin
Lavabo à poser
Aufsatzwaschbecken
Lavabo de apoio
Раковина умывальника накладная

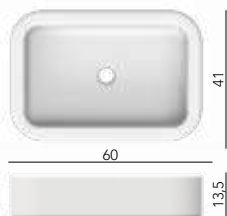

Senza troppo pieno - Consigliata piletta Art. 10034
Without overflow - Waste Art. 10034 recommended
Sans trop-plein - Bonde Art. 10034 conseillée
Ohne überlauf - Abfluss Art. 10034 empfohlen
Sin rebosadero - Recomendado desagüe Art. 10034
Без пробки перелива - Рекомендуется донный клапан арт. 10034

PALLET QUANTITY - 100x120x200h: 40

PALLET QUANTITY - 80x120x200h: 28

BIOKER + 115,00

Art. 8047/B

NEXT 40B - 41 x 50 Cm - 14 Kg - 6 L.



Lavabo da appoggio o sospeso

Lay-on or wall-mounted washbasin

Lavabo à poser ou suspendu

Aufsatz-oder Hängewaschbecken

Lavabo de apoyo o suspendido

Раковина умывальника накладная или подвесная

WHITE

345,00

#



Fissaggi a muro compresi - Senza troppo pieno - Consigliata piletta Art. 10034

Wall attachments included - Without overflow - Waste Art. 10034 recommended

Fixations murales incluses - Sans trop-plein - Bonde Art. 10034 conseillée

Wandbefestigungen inklusive - Ohne überlauf - Abfluss Art. 10034 empfohlen

Fijación pared incluida - Sin rebosadero - Recomendado desagüe Art. 10034

Настенные крепления входят в комплект - Без пробки перелива - Рекомендуется донный клапан арт. 10034

PALLET QUANTITY - 100x120x200h: 50

PALLET QUANTITY - 80x120x200h: 28

BIOKER + 115,00

Art. 8308

NEXT 60B - 60 x 46 Cm - 16 Kg - 7 L.



Lavabo da appoggio o sospeso

Lay-on or wall-mounted washbasin

Lavabo à poser ou suspendu

Aufsatz-oder Hängewaschbecken

Lavabo de apoyo o suspendido

Раковина умывальника накладная или подвесная

WHITE

460,00

#

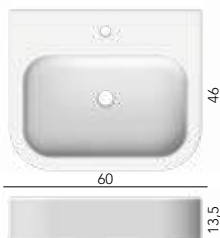

Fissaggi a muro compresi - Borchia troppo pieno compresa

Wall attachments included - Overflow cap included

Fixations murales incluses - Anneau trop-plein inclus

Wandbefestigungen inklusive - Beschlag für Überlaufschutz inklusive

Fijación pared incluida - Tachón rebosadero incluido

Настенные крепления входят в комплект - Перелив входит в комплект

PALLET QUANTITY - 100x120x200h: 34

PALLET QUANTITY - 80x120x200h: 26

BIOKER + 115,00

Art. 8047/D

NEXT 40D - 41 x 50 Cm - 14 Kg - 6 L.



Lavabo da semincasso

Semi built-in washbasin

Lavabo semi encastré

Vorbauwaschbecken

Lavabo de semiencaje

Раковина умывальника полувстраиваемая

WHITE

470,00



Senza troppo pieno - Consigliata piletta Art. 10034

Without overflow - Waste Art. 10034 recommended

Sans trop-plein - Bonde Art. 10034 conseillée

Ohne überlauf - Abfluss Art. 10034 empfohlen

Sin rebosadero - Recomendado desagüe Art. 10034

Без пробки перелива - Рекомендуется донный клапан арт. 10034

PALLET QUANTITY - 100x120x200h: 50

PALLET QUANTITY - 80x120x200h: 28

BIOKER + 115,00

Art. 8047/D-80

NEXT 80D - 81,5 x 51 Cm - 20 Kg - 8 L.



Lavabo da semincasso
Semi built-in washbasin
Lavabo semi encastré
Vorbauwaschbecken
Lavabo de semiencaje
Раковина умывальника полувстраиваемая

WHITE

515,00



PALLET QUANTITY - 100x120x200h: 24
PALLET QUANTITY - 80x120x200h: 12

BIOKER + 115,00

Art. 10034



Piletta lavabo da 1"1/4
con troppo pieno integrato
1"1/4 washbasin waste with overflow
Bonde lavabo de 1"1/4 avec trop-plein intégré
Waschbeckenabfluss 1"1/4 mit integriertem Überlaufschutz
Desagüe lavabo de 1"1/4 con rebosadero integrado
Донный клапан для умывальника 1"1/4 с интегрированным переливом

CR ●

200,00

NROP ●

220,00

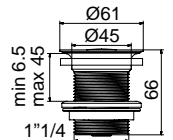

Art. 10010/C



Scarico automatico 1"1/4 click-clack, tappo grande
Automatic pop-waste 1" 1/4 click-clack, big plug
Bonde clic-clac, grand debit
Automatischer ablauf click-clack, crosser stöpsel
Valvula automática 1" 1/4 click-clack, tapón grande
Слив автоматический: клапан 1"1/4, большая пробка

CR ● / **NROP** ● + **WHITE** **105,00**

ORS ● + **WHITE**

145,00

MATCHING WCS AND BIDETS - WC ET BIDET COMBINABLES
 KOMBINIERBARE WCS UND BIDETS - WC BIDÉ COMBINABLES
 УНИТАЗЫ БИДЕ КОМБИНИРУЕМЫЕ



SHAPE 70x39
 Art. 8097



SHAPE 45
 Art. 8098



P_8

Art. 5520/CL - 50,5 x 36 - CLEAN FLUSH
 Art. 5521 - 50,5 x 36



P_11

Art. 5524/CL - 45 x 35 - CLEAN FLUSH
 Art. 5525 - 45 x 35



P_9

Art. 5522 - 54,5 x 36
 Art. 5522/CL - 54,5 x 36 - CLEAN FLUSH
 Art. 5523 - 54,5 x 36



P_10

Art. 5526/CL - 66 x 36 - CLEAN FLUSH
 Art. 5527 - 36 x 15 - CISTERN



P_76

Art. 8604 - 55 x 41
 Art. 8605 - 55 x 41



P_76/77

Art. 8606 - 55 x 41
 Art. 8607 - 55 x 41



P_68

Art. 8105 - 50 x 45
 Art. 8105/CL - 50 x 45 - CLEAN FLUSH
 Art. 8106 - 50 x 45



P_69

Art. 8401 - 50 x 45
 Art. 8403 - 50 x 45



P_69

Art. 8404 - 38 x 14,5 x h95,5

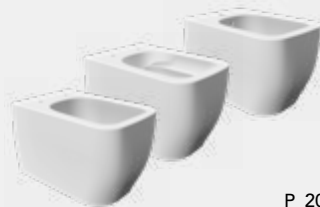

P_20

Art. 5126/TW - 52 x 36 - TWIST
 Art. 5126/CL - 52 x 36 - CLEAN FLUSH
 Art. 5127 - 52 x 36



P_21

Art. 5138/CL - 55 x 36 - CLEAN FLUSH
 Art. 5139 - 55 x 36



P_22

Art. 5140/CL - 66 x 36 - CLEAN FLUSH
 Art. 5141 - 35 x 15 - CISTERN



P_48

Art. 5201/TW - 50,5 x 36 - TWIST
 Art. 5202 - 50,5 x 36



P_126

Art. 8701 - 50 x 35
 Art. 8702 - 50 x 35



P_58

Art. 8812 - 53,5 x 36
 Art. 8812/CL - 53,5 x 36 - CLEAN FLUSH
 Art. 8813 - 53,5 x 36
 Art. 8815 - 40 x 29 - KIDS WC

Art. 8097

SHAPE 70 x 39 - 70 x 39 Cm - 10 Kg - 2,5 L.



Lavabo da appoggio
Lay-on washbasin
Lavabo à poser
Aufsatzwaschbecken
Lavabo de apoyo
Раковина умывальника накладная

WHITE

395,00



Borchia troppo pieno compresa
Overflow cap included
Anneau trop-plein inclus
Beschlag für Überlaufschutz inklusive
Tachón rebosadero incluido
Перелив входит в комплект

PALLET QUANTITY - 100x120x200h: 36
PALLET QUANTITY - 80x120x200h: 34

BIOKER + 115,00

Art. 8098

SHAPE 45 - Ø45 Cm - 9 Kg - 1 L.



Lavabo da appoggio
Lay-on washbasin
Lavabo à poser
Aufsatzwaschbecken
Lavabo de apoyo
Раковина умывальника накладная

WHITE

350,00

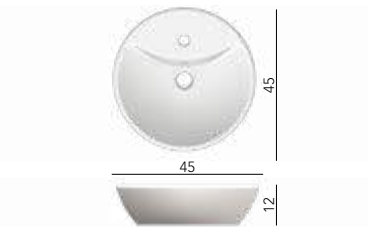

Borchia troppo pieno compresa
Overflow cap included
Anneau trop-plein inclus
Beschlag für Überlaufschutz inklusive
Tachón rebosadero incluido
Перелив входит в комплект

PALLET QUANTITY - 100x120x200h: 68
PALLET QUANTITY - 80x120x200h: 40

BIOKER + 115,00

Art. 10034



Piletta lavabo da 1"1/4
con troppo pieno integrato
1"1/4 washbasin waste with overflow
Bonde lavabo de 1"1/4 avec trop-plein intégré
Waschbeckenabfluss 1"1/4 mit integriertem Überlaufschutz
Desagüe lavabo de 1"1/4 con rebosadero integrado
Донный клапан для умывальника 1"1/4 с интегрированным переливом

CR ●

200,00

NROP ●

220,00

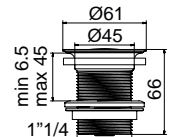

Art. 10010/C



Scarico automatico 1"1/4 click-clack, tappo grande
Automatic pop-waste 1" 1/4 click-clack, big plug
Bonde clic-clac, grand debit
Automatischer ablauf click-clack, crosser stöpsel
Valvula automática 1" 1/4 click-clack, tapón grande
Слив автоматический: клапан 1"1/4, большая пробка

CR ● / **NROP** ● + **WHITE** **105,00**

ORS ● + **WHITE**

145,00



IN-OUT 30
Art. 8020



IN-OUT 40
Art. 8021



GIOVE
Art. 8034



LUNA
Art. 8003



RONDO'
Art. 8008



ZEFIRO 50
Art. 8207



ZEFIRO 70
Art. 8206



WISH SHELF DX
Art. 2011



WISH SHELF SX
Art. 2012



WISH URINAL
Art. 2014

WC BIDET ABBINABILI

MATCHING WCS AND BIDETS - WC ET BIDET COMBINABLES
KOMBINIERBARE WCS UND BIDETS - WC BIDÉ COMBINABLES
УНИТАЗЫ БИДЕ КОМБИНИРУЕМЫЕ



P_8

Art. 5520/CL - 50,5 x 36 - CLEAN FLUSH
Art. 5521 - 50,5 x 36



P_11

Art. 5524/CL - 45 x 35 - CLEAN FLUSH
Art. 5525 - 45 x 35



P_9

Art. 5522 - 54,5 x 36
Art. 5522/CL - 54,5 x 36 - CLEAN FLUSH
Art. 5523 - 54,5 x 36



P_10

Art. 5526/CL - 66 x 36 - CLEAN FLUSH
Art. 5527 - 36 x 15 - CISTERN

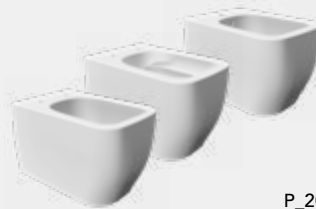

P_20

Art. 5126/TW - 52 x 36 - TWIST
Art. 5126/CL - 52 x 36 - CLEAN FLUSH
Art. 5127 - 52 x 36



P_21

Art. 5138/CL - 55 x 36 - CLEAN FLUSH
Art. 5139 - 55 x 36



P_22

Art. 5140/CL - 66 x 36 - CLEAN FLUSH
Art. 5141 - 35 x 15 - CISTERN



P_48

Art. 5201/TW - 50,5 x 36 - TWIST
Art. 5202 - 50,5 x 36



P_126

Art. 8701 - 50 x 35
Art. 8702 - 50 x 35



P_58

Art. 8812 - 53,5 x 36
Art. 8812/CL - 53,5 x 36 - CLEAN FLUSH
Art. 8813 - 53,5 x 36
Art. 8815 - 40 x 29 - KIDS WC

Art. 8020

IN-OUT 30 - Ø29,5 H16 Cm - 5 Kg - 2 L.



Lavabo da incasso
Built-in washbasin
Lavabo encastré par dessus
Einbauwaschbecken
Lavabo de encaje
Раковина умывальника встраиваемая

WHITE

175,00



Senza troppo pieno - Consigliata piletta Art. 10034
Without overflow - Waste Art. 10034 recommended
Sans trop-plein - Bonde Art. 10034 conseillée
Ohne überlauf - Abfluss Art. 10034 empfohlen
Sin rebosadero - Recomendado desagüe Art. 10034
Без пробки перелива - Рекомендуется донный клапан арт. 10034

PALLET QUANTITY - 100x120x200h: 96
PALLET QUANTITY - 80x120x200h: 55

BIOKER + 115,00

Art. 8021

IN-OUT 40 - Ø39,5 H18 Cm - 7 Kg - 3,5 L.



Lavabo da incasso
Built-in washbasin
Lavabo encastré par dessus
Einbauwaschbecken
Lavabo de encaje
Раковина умывальника встраиваемая

WHITE

225,00



Borchia troppo pieno compresa
Overflow cap included
Anneau trop-plein inclus
Beschlag für Überlaufschutz inklusive
Tachón rebosadero incluido
Перелив входит в комплект

PALLET QUANTITY - 100x120x200h: 50
PALLET QUANTITY - 80x120x200h: 36

BIOKER + 115,00

Art. 8034

GIOVE - Ø37 Cm - 8 Kg - 4 L.



Lavabo da appoggio
Lay-on washbasin
Lavabo à poser
Aufsatzwaschbecken
Lavabo de apoyo
Раковина умывальника накладная

WHITE

275,00

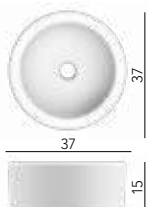

Senza troppo pieno - Consigliata piletta Art. 10034
Without overflow - Waste Art. 10034 recommended
Sans trop-plein - Bonde Art. 10034 conseillée
Ohne überlauf - Abfluss Art. 10034 empfohlen
Sin rebosadero - Recomendado desagüe Art. 10034
Без пробки перелива - Рекомендуется донный клапан арт. 10034

PALLET QUANTITY - 100x120x200h: 50
PALLET QUANTITY - 80x120x200h: 36

BIOKER + 115,00

Art. 8003

LUNA - Ø40 Cm - 8 Kg - 4 L.



Lavabo da appoggio
Lay-on washbasin
Lavabo à poser
Aufsatzwaschbecken
Lavabo de apojo
Раковина умывальника накладная

WHITE

245,00



Borchia troppo pieno compresa
Overflow cap included
Anneau trop-plein inclus
Beschlag für Überlaufschutz inklusive
Tachón rebosadero incluido
Перелив входит в комплект

PALLET QUANTITY - 100x120x200h: 50
PALLET QUANTITY - 80x120x200h: 36

BIOKER + 115,00

Art. 8008

RONDO' - Ø48 Cm - 12 Kg - 3 L.



Lavabo da incasso
Built-in washbasin
Lavabo encastré
Einbauwaschbecken
Lavabo de encaje
Раковина умывальника встраиваемая

WHITE

360,00

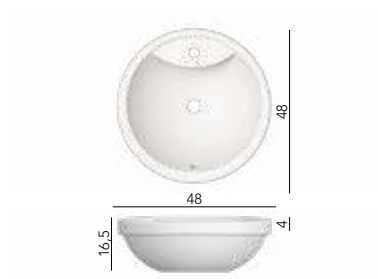

Borchia troppo pieno compresa
Overflow cap included
Anneau trop-plein inclus
Beschlag für Überlaufschutz inklusive
Tachón rebosadero incluido
Перелив входит в комплект

PALLET QUANTITY - 100x120x200h: 50
PALLET QUANTITY - 80x120x200h: 28

BIOKER + 115,00

Art. 8207

ZEFIRO 50 - 49 x 36 Cm - 6 Kg - 3,5 L.



Lavabo da appoggio
Lay-on washbasin
Lavabo à poser
Aufsatzwaschbecken
Lavabo de apojo
Раковина умывальника накладная

WHITE

350,00

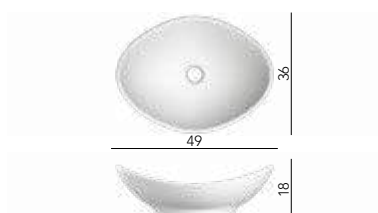

Senza troppo pieno - Consigliata piletta Art. 10034
Without overflow - Waste Art. 10034 recommended
Sans trop-plein - Bonde Art. 10034 conseillée
Ohne überlauf - Abfluss Art. 10034 empfohlen
Sin rebosadero - Recomendado desagüe Art. 10034
Без пробки перелива - Рекомендуется донный клапан арт. 10034

PALLET QUANTITY - 100x120x200h: 40
PALLET QUANTITY - 80x120x200h: 28

BIOKER + 115,00

Art. 8206

ZEFIRO 70 - 68 x 36 Cm - 8 Kg - 4,5 L.



Lavabo da appoggio
Lay-on washbasin
Lavabo à poser
Aufsatzwaschbecken
Lavabo de apoyo
Раковина умывальника накладная

WHITE

390,00



Senza troppo pieno - Consigliata piletta Art. 10034
Without overflow - Waste Art. 10034 recommended
Sans trop-plein - Bonde Art. 10034 conseillée
Ohne überlauf - Abfluss Art. 10034 empfohlen
Sin rebosadero - Recomendado desagüe Art. 10034
Без пробки перелива - Рекомендуется донный клапан арт. 10034

PALLET QUANTITY - 100x120x200h: 31
PALLET QUANTITY - 80x120x200h: 24

BIOKER + 115,00

Art. 2011

WISH SHELF DX - 87 x 52 Cm - 20 Kg - 2 L.



Lavabo da appoggio o sospeso
Lay-on or wall-mounted washbasin
Lavabo à poser ou suspendu
Aufsatz-oder Hängewaschbecken
Lavabo de apoyo o suspendido
Раковина умывальника накладная или подвесная

WHITE

650,00



Fissaggi a muro compresi - Borchia troppo pieno compresa
Wall attachments included - Overflow cap included
Fixations murales incluses - Anneau trop-plein inclus
Wandbefestigungen inklusive - Beschlag für Überlaufschutz inklusive
Fijación pared incluida - Tachón rebosadero incluido
Настенные крепления входят в комплект - Перелив входит в комплект

PALLET QUANTITY - 100x120x200h: 20
PALLET QUANTITY - 80x120x200h: 16

BIOKER + 115,00

Art. 2012

WISH SHELF SX - 87 x 52 Cm - 20 Kg - 2 L.



Lavabo da appoggio o sospeso
Lay-on or wall-mounted washbasin
Lavabo à poser ou suspendu
Aufsatz-oder Hängewaschbecken
Lavabo de apoyo o suspendido
Раковина умывальника накладная или подвесная

WHITE

650,00



Fissaggi a muro compresi - Borchia troppo pieno compresa
Wall attachments included - Overflow cap included
Fixations murales incluses - Anneau trop-plein inclus
Wandbefestigungen inklusive - Beschlag für Überlaufschutz inklusive
Fijación pared incluida - Tachón rebosadero incluido
Настенные крепления входят в комплект - Перелив входит в комплект

PALLET QUANTITY - 100x120x200h: 20
PALLET QUANTITY - 80x120x200h: 16

BIOKER + 115,00

Art. 2014

WISH URINAL - 28 x 30 x 69,5 Cm - 15 Kg

WHITE

470,00

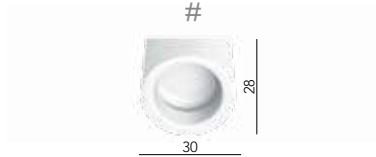

Urinatoio da parete
Wall-mounted urinal
Urinoir mural
Wand-Urinal
Urinario de pared
Писсуар напольный

PALLET QUANTITY - 100x120x200h: 40
PALLET QUANTITY - 80x120x200h: 32

BIOKER + 115,00

Art. 10034



Piletta lavabo da 1"1/4
con troppo pieno integrato

1"1/4 washbasin waste with overflow

Bonde lavabo de 1"1/4 avec trop-plein intégré

Waschbeckenabfluss 1"1/4 mit integriertem Überlaufschutz

Desagüe lavabo de 1"1/4 con rebosadero integrado

Донный клапан для умывальника 1"1/4 с интегрированным переливом

CR ●

200,00

NROP ●

220,00

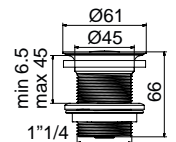

Art. 10010/C



Scarico automatico 1"1/4 click-clack, tappo grande

Automatic pop-waste 1" 1/4 click-clack, big plug

Bonde clic-clac, grand debit

Automatischer ablauf click-clack, crosser stöpsel

Valvula automática 1" 1/4 click-clack, tapón grande

Слив автоматический: клапан 1"1/4, большая пробка

CR ● / NROP ●

+ WHITE 105,00

ORS ●

+ WHITE 145,00



UP SHELF DX
Art. 1890



UP SHELF SX
Art. 1891



Art. 1890

UP SHELF DX - 86 x 50 x h7 cm



Lavello da cucina
Kitchen sink
Évier de cuisine
Spülbecken
Fregadero
Кухонная мойка

WHITE 1.000,00

COLORS 1.750,00

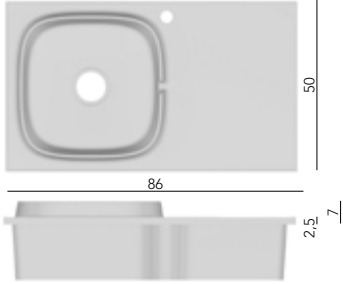
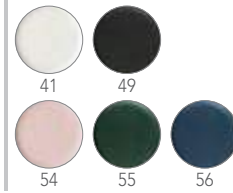

Borchia troppo pieno compresa
Overflow cap included
Anneau trop-plein inclus
Beschlag für Überlaufschutz inklusive
Tachón rebosadero incluido
Перелив входит в комплект

PALLET QUANTITY - 100x120x200h: 12

PALLET QUANTITY - 80x120x200h: 8

BIOKER + 115,00

Art. 1891

UP SHELF SX - 86 x 50 x h7 cm



Lavello da cucina
Kitchen sink
Évier de cuisine
Spülbecken
Fregadero
Кухонная мойка

WHITE 1.000,00

COLORS 1.750,00

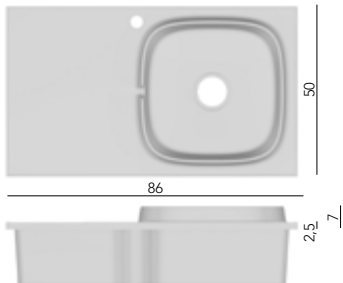
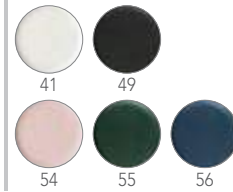

Borchia troppo pieno compresa
Overflow cap included
Anneau trop-plein inclus
Beschlag für Überlaufschutz inklusive
Tachón rebosadero incluido
Перелив входит в комплект

PALLET QUANTITY - 100x120x200h: 12

PALLET QUANTITY - 80x120x200h: 8

BIOKER + 115,00



CASTELLANA WC
Art. 5306



CASTELLANA BIDET
Art. 5307



CASTELLANA HIGH LEVEL CISTERN
Art. 5364



CASTELLANA LOW LEVEL CISTERN
Art. 5365



CASTELLANA MONOBLOCK
Art. 5308



CASTELLANA CISTERN
Art. 5309 - 5309/B



CASTELLANA 70
Art. 5301



CASTELLANA 90
Art. 5302



CASTELLANA 120
Art. 5303



CASTELLANA PEDESTAL
Art. 5305



CASTELLANA CERAMIC LEGS
Art. 5304



CASTELLANA METAL LEGS
Art. 5355



CASTELLANA BATHTUB
Art. 5359



CASTELLANA ACCESORIES

Art. 5306

CASTELLANA WC - 54 x 39 Cm - 28 Kg



Wc a terra
Floor-mounted wc
Cuvette au sol
Bodenstehendes wc
Inodoro a tierra
Унитаз напольный



WHITE

480,00



PALLET QUANTITY - 100x120x200h: 15+CW
PALLET QUANTITY - 80x120x200h: 14+CW

BIOKER + 115,00

Art. 5349

FLUSH PLATE



Placca di comando per cassetta Geberit
Push button flush plate for Geberit
Plaque de commande à bouton-poussoir pour Geberit
Wandspül Platte für Spülkasten Geberit
Placa de accionamiento con pulsador para Geberit
Кнопки для смывного механизма Geberit

CHROME

980,00



GOLD / BRONZE

1.190,00



Art. 5307

CASTELLANA BIDET - 54 x 39 Cm - 26 Kg



Bidet a terra
Floor-mounted bidet
Bidet au sol
Bodenstehendes Bidet
Bidet a tierra
Биде напольное

WHITE

480,00

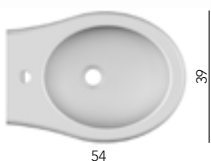

PALLET QUANTITY - 100x120x200h: 20
PALLET QUANTITY - 80x120x200h: 16

BIOKER + 115,00

Art. 5308

CASTELLANA MONOBLOCK - 73 x 40 Cm - 40 Kg



Wc monoblocco
Monoblock WC
Cuvette monobloc
WC-Kombination
Inodoro monobloque
Wc monoblocco



WHITE

600,00

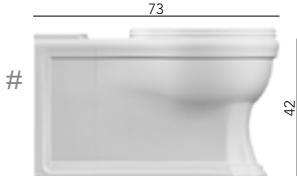

PALLET QUANTITY - 100x120x200h: 9+CW+CASS
PALLET QUANTITY - 80x120x200h: 6+CW+CASS

BIOKER + 115,00

Art. 5309

CASTELLANA CISTERN - 46 x 19 Cm - 19 Kg



Cassetta a muro, comprensiva di batteria a doppio flusso 6/4,5 lt

Wall cistern, inclusive of flushing system dual-flush 6/4,5 l

Réservoir de chasse mural avec mecanisme de chasse à double flux 6/4,5 L

Wandspülkasten, einschließlich Batterie mit Doppelspülung 6/4,5 lt

Cisterna de pared, incluido mecanismo doble flujo 6/4,5 lt

Бачок сливной внутривысменный с сифоном двухрежимного слива, 6/4,5л

WHITE

290,00

+ METAL PARTS

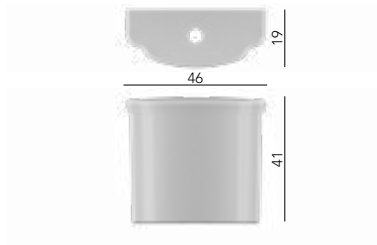

PER - FOR - POUR - FÜR - PARA - ДЛЯ: ART. 5308

Entrata acqua da 1/2"

1/2" inch inlet
Entrée eau 1/2 pouce
Wassereinfluss mit 1/2 zoll
Entrada de agua de 1/2"
Вход воды, 1/2"

BIOKER + 115,00

Art. 5309/B

CASTELLANA CISTERN - 46 x 19 Cm - 19 Kg



Cassetta a muro, comprensiva di batteria, flusso 6 lt

Wall cistern, inclusive of flushing system, flush 6 l

Réservoir de chasse mural avec mecanisme de chasse, flux 6 L

Wandspülkasten, einschließlich Batterie, spülung 6 lt

Cisterna de pared, incluido mecanismo, flujo 6 lt

Бачок сливной внутривысменный с сифоном слива, 6 л

WHITE

470,00

+ METAL PARTS

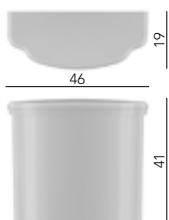
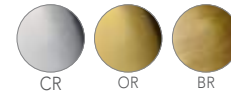

PER - FOR - POUR - FÜR - PARA - ДЛЯ: ART. 5308

Entrata acqua da 1/2"

1/2" inch inlet
Entrée eau 1/2 pouce
Wassereinfluss mit 1/2 zoll
Entrada de agua de 1/2"
Вход воды, 1/2"

BIOKER + 115,00

Art. 5364

CASTELLANA HIGH CISTERN - 46 x 19 Cm - 19 Kg



Cassetta a muro, comprensiva di batteria, flusso 6 lt
 Wall cistern, inclusive of flushing system, flush 6 l
 Réservoir de chasse mural avec mecanisme de chasse, flux 6 L
 Wandspülkasten, einschließlich Batterie, spülung 6 lt
 Cisterna de pared, incluido mecanismo, flujo 6 lt
 Бачок сливной внутрискстенный с сифоном слива, 6 л

WHITE

950,00

+ METAL PARTS

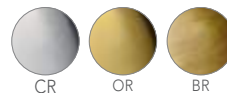

PER - FOR - POUR - FÜR - PARA - ДЛЯ: ART. 5308

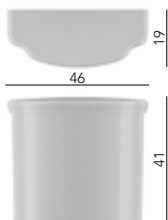

Entrata acqua da 1/2"
 1/2" inch inlet
 Entrée eau 1/2 pouce
 Wassereinlauf mit 1/2 zoll
 Entrada de agua de 1/2"
 Вход воды, 1/2"

BIOKER + 115,00

Art. 5365

CASTELLANA LOW CISTERN - 46 x 19 Cm - 19 Kg



Cassetta a muro, comprensiva di batteria, flusso 6 lt
 Wall cistern, inclusive of flushing system, flush 6 l
 Réservoir de chasse mural avec mecanisme de chasse, flux 6 L
 Wandspülkasten, einschließlich Batterie, spülung 6 lt
 Cisterna de pared, incluido mecanismo, flujo 6 lt
 Бачок сливной внутрискстенный с сифоном слива, 6 л

WHITE

560,00

+ METAL PARTS



PER - FOR - POUR - FÜR - PARA - ДЛЯ: ART. 5308

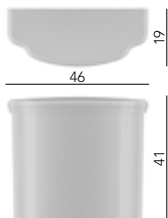

Entrata acqua da 1/2"
 1/2" inch inlet
 Entrée eau 1/2 pouce
 Wassereinlauf mit 1/2 zoll
 Entrada de agua de 1/2"
 Вход воды, 1/2"

BIOKER + 115,00

Art. 5310/A

CASTELLANA WOOD SEAT COVER



Sedile per Wc in legno
 Wooden seat cover Wc
 Abattant wc en bois
 WC-deckel aus Holz
 Asiento para inodoro en madera
 Сиденье унитаза дерево

WOOD CHROME 210,00



WOOD GOLD / BRONZE 275,00



Art. 5310/B

CASTELLANA WOOD SEAT COVER

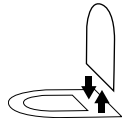

Sedile per Wc in legno
 Wooden seat cover Wc
 Abattant wc en bois
 WC-deckel aus Holz
 Asiento para inodoro en madera
 Сиденье унитаза дерево
 Con cerniere cromate - Sgancio rapido
 With chromed Kit - Rapid lift system
 Charnières chromées - Décrochage rapide
 Mit scharniere chrom - Schnellbefestigung
 Bisagras cromadas - Desenganche rápido
 С хромированными шарнирами - Быстрое отсоединение

WOOD CHROME 275,00



WOOD GOLD / BRONZE 290,00



Art. 5553/A

CASTELLANA WHITE SEAT COVER



Sedile per Wc in Poliestere
 Polyester seat cover Wc
 Abattant wc en polyester
 WC-deckel in Polyester
 Asiento para inodoro en poliéster
 Сиденье унитаза в полиэфире

WHITE CHROME 150,00



WHITE GOLD / BRONZE 210,00



Art. 5553/B

CASTELLANA WHITE SEAT COVER

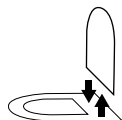

Sedile per Wc in Poliestere
 Polyester seat cover Wc
 Abattant wc en polyester
 WC-deckel in Polyester
 Asiento para inodoro en poliéster
 Сиденье унитаза в полиэфире
 Con cerniere cromate - Sgancio rapido
 With chromed Kit - Rapid lift system
 Charnières chromées - Décrochage rapide
 Mit scharniere chrom - Schnellbefestigung
 Bisagras cromadas - Desenganche rápido
 С хромированными шарнирами - Быстрое отсоединение

WHITE CHROME 200,00



WHITE GOLD / BRONZE 275,00



Art. 5301

CASTELLANA 70 - 70,5 x 53 Cm - 21,5 Kg - 5 L.

Lavabo da appoggio o sospeso

Lay-on or wall-mounted washbasin

Lavabo à poser ou suspendu

Aufsatz-oder Hängewaschbecken

Lavabo de apoyo o suspendido

Раковина умывальника накладная или подвесная

WHITE

560,00

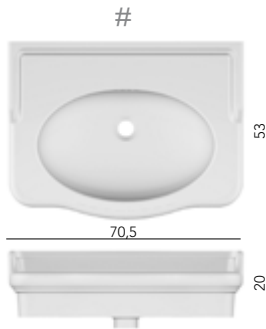

Fissaggi a muro compresi

Wall attachments included

Fixations murales incluses

Wandbefestigungen inklusive

Fijación pared incluida

Настенные крепления входят в комплект

PALLET QUANTITY - 100x120x200h: 20

PALLET QUANTITY - 80x120x200h: 12

BIOKER + 115,00

Art. 5302

CASTELLANA 90 - 91 x 53,5 Cm - 28,5 Kg - 6 L.

Lavabo da appoggio o sospeso

Lay-on or wall-mounted washbasin

Lavabo à poser ou suspendu

Aufsatz-oder Hängewaschbecken

Lavabo de apoyo o suspendido

Раковина умывальника накладная или подвесная

WHITE

770,00

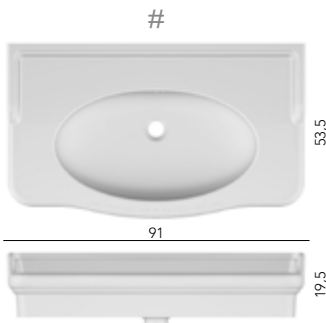

Fissaggi a muro compresi

Wall attachments included

Fixations murales incluses

Wandbefestigungen inklusive

Fijación pared incluida

Настенные крепления входят в комплект

PALLET QUANTITY - 100x120x200h: 17

PALLET QUANTITY - 80x120x200h: 9

BIOKER + 115,00

Art. 5303

CASTELLANA 120 - 126 x 52,5 Cm - 39,5 Kg - 6 L.

Lavabo da appoggio o sospeso

Lay-on or wall-mounted washbasin

Lavabo à poser ou suspendu

Aufsatz-oder Hängewaschbecken

Lavabo de apoyo o suspendido

Раковина умывальника накладная или подвесная

WHITE

1.000,00

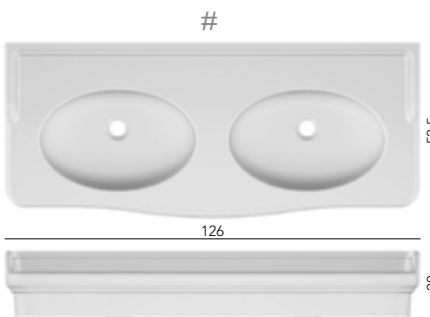

Fissaggi a muro compresi

Wall attachments included

Fixations murales incluses

Wandbefestigungen inklusive

Fijación pared incluida

Настенные крепления входят в комплект

PALLET QUANTITY - 100x120x200h: 14

PALLET QUANTITY - 80x120x200h: 9

BIOKER + 115,00

Art. 5305

CASTELLANA PEDESTAL - h 73 x 32,5 x 32 Cm

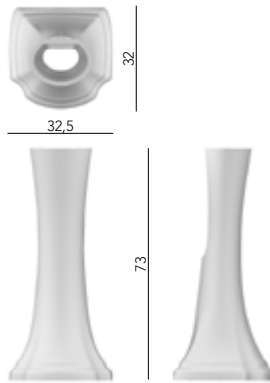

Colonna aperta posteriormente
 Column with open rear
 Colonne ouverte à l'arrière
 Hinten offene Säule
 Columna abierta posteriormente
 Ножка с открытой тыльной стороной

WHITE 430,00

PER - FOR - POUR - FÜR - PARA - ДЛЯ:

ART. 5301 - 5302 - 5303

PALLET QUANTITY - 100x120x200h: 24

PALLET QUANTITY - 80x120x200h: 15

BIOKER + 115,00

Art. 5304

CASTELLANA CERAMIC LEGS - h 73 Cm

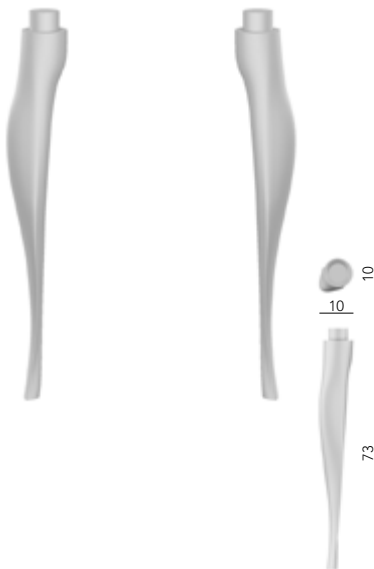

Coppia di gambe
 Couple of legs
 Paire de pieds
 Paar beine
 Ножка с открытой тыльной стороной

WHITE 430,00

PER - FOR - POUR - FÜR - PARA - ДЛЯ:

ART. 5301 - 5302 - 5303

PALLET QUANTITY - 100x120x200h: 100

PALLET QUANTITY - 80x120x200h: 75

BIOKER + 115,00

Art. 5355

CASTELLANA METAL LEGS - h 82 Cm

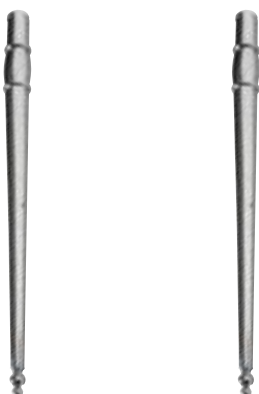

Coppia di gambe
 Couple of legs
 Paire de pieds
 Paar beine
 Ножка с открытой тыльной стороной

CHROME 1.300,00



GOLD / BRONZE 1.500,00



PER - FOR - POUR - FÜR - PARA - ДЛЯ:

ART. 5301 - 5302 - 5303

Art. 5356/A

FRAME WITH SHELF 90 - L 90 - P 36,5 Cm



Telaio con mensola di vetro
 Frame with shelf
 Cadre avec étagère en verre
 Rahmen mit ablage
 Marco con repisa
 Рама с полкой

PER - FOR - POUR - FÜR - PARA - ДЛЯ:
 ART. 5355 + 5302

CHROME 310,00



CR

GOLD / BRONZE 395,00



OR

BR

Art. 5356/B

FRAME WITH SHELF 70 - L 70 - P 36,5 Cm



Telaio con mensola di vetro
 Frame with shelf
 Cadre avec étagère en verre
 Rahmen mit ablage
 Marco con repisa
 Рама с полкой

PER - FOR - POUR - FÜR - PARA - ДЛЯ:
 ART. 5355 + 5301

CHROME 285,00



CR

GOLD / BRONZE 365,00



OR

BR

Art. 5357/A

BRASS GRILLE 90 - L 90 - P 36,5 Cm



Griglia in ottone
 Brass grille
 Grille en laiton
 Gitter aus messing
 Rejilla de latón
 Решетка латунная

PER - FOR - POUR - FÜR - PARA - ДЛЯ:
 ART. 5355 + 5302

CHROME 550,00



CR

GOLD / BRONZE 670,00



OR

BR

Art. 5357/B

BRASS GRILLE 70 - L 70 - P 36,5 Cm



Griglia in ottone
 Brass grille
 Grille en laiton
 Gitter aus messing
 Rejilla de latón
 Решетка латунная

PER - FOR - POUR - FÜR - PARA - ДЛЯ:
 ART. 5355 + 5301

CHROME 525,00



CR

GOLD / BRONZE 650,00

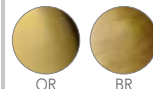

OR

BR

Art. 5352

SIDE TOWEL RAIL - P 38 Cm



Porta asciugamani laterale per lavabo DX o SX
 Side towel rail for RH or LH washbasin
 Porte-serviettes latéral pour lavabo DTE ou GCH
 Handtuchhalter für waschbeckenseite RECHTS oder LINKS
 Toallero lateral para lavabo DCH o IZQ
 Держатель полотенец для раковины умывальника, боковой, левый или правый

PER - FOR - POUR - FÜR - PARA - ДЛЯ:
 ART. 5301 - 5302 - 5303

CHROME 220,00



CR

GOLD / BRONZE 265,00

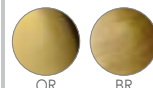

OR

BR

Art. 5359

CASTELLANA BATHTUB - 170 x 80 x h 72 Cm - 60 Kg

Vasca con colonna di scarico e set piedi inclusi
 Bathtub with waste and feet included
 Baignoire avec tuyau d'évacuation et set pieds inclus
 Wanne inklusive Abflussrohr und Füßen
 Bañera con desagüe y 4 pies incluidos
 Ванна с колонной слива и ножками

WHITE WHITE 3.100,00

WHITE CHROME 3.100,00



WHITE GOLD / BRONZE 3.350,00



Art. 5360

SPARE FEET AND BRACKETS

Staffe e piedini di ricambio
 Spare feet and brackets
 Supports et pieds de rechange
 Ersatzbügel und -füsse
 Soportes y pies de recambio
 Кронштейны и опоры запасные



WHITE 750,00

CHROME 750,00



GOLD / BRONZE 990,00



Art. 5320
WALL MOUNTED SOAP DISH

Porta sapone da muro
Wall mounted soap dish
Porte-savon mural
Seifenschale für Wandmontage
Porta jabón de pared
Мыльница настенная

WHITE CHROME 125,00

WHITE GOLD / BRONZE 140,00

Art. 5321
WALL MOUNTED TUMBLER

Porta spazzolino da muro
Wall mounted tumbler
Porte-brosses à dent mural
Zahnbürstenbecher für Wandmontage
Porta cepillo de pared
Стакан для зубных щеток настенный

WHITE CHROME 125,00

WHITE GOLD / BRONZE 140,00

Art. 5322
WALL-MOUNTED DISPENSER

Dispenser da muro
Wall-mounted dispenser
Distributeur mural
Seifenspender zur wandmontage
Dispenser de pared
Диспенсер настенный

WHITE CHROME 180,00

WHITE GOLD / BRONZE 220,00

Art. 5323
LAID-ON SOAP DISH

Porta sapone da appoggio
Laid-on soap dish
Porte-savon à poser
Seifenschale zum aufstellen
Jabonera en apojo
Мыльница настольная

WHITE CHROME 160,00

WHITE GOLD / BRONZE 195,00

Art. 5324
LAID-ON TUMBLER HOLDER

Porta bicchiere da appoggio
Laid-on tumbler holder
Porte-gobelet à poser
Glashalter zum aufstellen
Portavaso en apojo
Держатель стакана настольный

WHITE CHROME 155,00

WHITE GOLD / BRONZE 190,00

Art. 5325
LAID-ON DISPENSER

Dispenser da appoggio
Laid-on dispenser
Distributeur pour lavabo
Seifenspender zum aufstellen
Dispenser en apojo
Диспенсер настольный

WHITE CHROME 210,00

WHITE GOLD / BRONZE 250,00

Art. 5316

TOWEL BAR - L 60 Cm



Porta asciugamani
Towel bar
Porte-Serviettes
Handtuchhalter
Toallero
Держатель полотенец

CHROME 215,00



GOLD / BRONZE 255,00



Art. 5317

TOWEL BAR - L 45 Cm



Porta asciugamani
Towel bar
Porte-Serviettes
Handtuchhalter
Toallero
Держатель полотенец

CHROME 205,00



GOLD / BRONZE 250,00



Art. 5318

TOWEL BAR - L 30 Cm



Porta asciugamani
Towel bar
Porte-Serviettes
Handtuchhalter
Toallero
Держатель полотенец

CHROME 185,00



GOLD / BRONZE 225,00

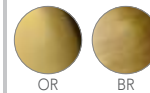

Art. 5315

WALL MOUNTED GLASS SHELF - L 60 Cm



Mensola in vetro
Wall mounted glass shelf
Étagère en verre
Glasablage für wandmontage
Estante con cristal
Стеклопанельная полка

CHROME 225,00



GOLD / BRONZE 250,00



Art. 5350

DOUBLE GLASS SHELF - L45 P15 h38 Cm



Mensola doppia in vetro
Double glass shelf
Double étagère en verre
Doppelte ablage aus glas
Repisa doble de vidrio
Полка двойная стеклянная

CHROME 585,00



GOLD / BRONZE 700,00



Art. 5319

WALL MOUNTED TOWEL RING



Porta salviette anello
Wall mounted towel ring
Anneau porte-serviette
Ringförmiger Handtuchhalter
Toallero mural redondo
Полотенцедержатель кольцо

CHROME 160,00



GOLD / BRONZE 195,00

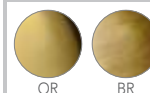

Art. 5331
WALL MOUNTED ROBE HOOK

Appendiabiti singolo
 Wall mounted robe hook
 Porte-manteau individuel
 Kleiderhaken einzeln
 Colgador
 Крючок

CHROME 100,00

GOLD / BRONZE 115,00

Art. 5330
WALL MOUNTED DOUBLE HOOK

Appendiabiti doppio
 Wall mounted double hook
 Porte-manteau double
 Kleiderhaken doppelt
 Colgador
 Крючок двойной

CHROME 140,00

GOLD / BRONZE 165,00

Art. 5326
WALL MOUNTED TOILET ROLL HOLDER

Porta rotolo da muro
 Wall mounted toilet roll holder
 Porte-rouleau WC mural
 Toilettenpapierhalter für Wandmontage
 Porta papel mural
 Держатель для туалетной бумаги

CHROME 155,00

GOLD / BRONZE 190,00

Art. 5327
WALL MOUNTED TOILET ROLL HOLDER

Porta rotolo da muro con cover
 Wall mounted toilet roll holder
 Porte-rouleau WC mural
 Toilettenpapierhalter für Wandmontage
 Porta papel mural
 Держатель для туалетной бумаги

CHROME 195,00

GOLD / BRONZE 230,00

Art. 5328
WALL MOUNTED TOILET BRUSH

Portascopino da muro
 Wall mounted toilet brush
 Porte-balayette mural
 WC-Bürstenständer für Wandmontage
 Pareja de patas
 Навесной ёршик

WHITE CHROME 205,00

WHITE GOLD / BRONZE 250,00

Art. 5329
FREESTANDING TOILET BRUSH

Portascopino da terra
 Freestanding toilet brush
 Porte-balayette au sol
 Toilettenbürstenhalter für Boden
 Escobillero
 Напольный ёршик

CHROME 210,00

GOLD / BRONZE 255,00

Art. 5332

TOWEL HOLDER STAND - h 90 Cm



Piantana porta salviette tre bracci
Towel holder stand
Porte-serviette sur pied trois bras
Dreiarmliger Handtuch-Ständer
Pedestal con toallero
Стойка с тремя полотенцедержателями

CHROME 610,00



GOLD / BRONZE 740,00



Art. 5333

TOILET BRUSH AND TOILET ROLL HOLDER STAND - h 65 Cm



Piantana carta-scopino
Toilet brush and toilet roll holder stand
Porte-papier et balayette sur pied
Toilettenpapier/WC-Bürsten-Stände
Pedestal con porta papel y escobillero
Стойка с ёршиком и держателем для бумаги

CHROME 535,00



GOLD / BRONZE 610,00



Art. 5334

ROLL-SOAP-TOWEL-BRUSH- HOLDER - h 65 Cm



Piantana carta-sapone-salvietta-scopino
Roll-soap-towel-brush- holder
Porte papier-savon-serviette-balayette sur pied
Ständer für Handtuch/Toilettenpapier/Seife/WC-Bürsten
Pedestal con jabonera-porta papel-toallero escobillero
Стойка с ёршиком, мыльницей, полотенцедержателем и ёршиком

CHROME 655,00



GOLD / BRONZE 780,00

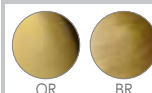

Art. 5348

DUST BEAN - Ø 19 x h 25 Cm



Pattumiera
Dust bean
Poubelle
Mülleimer
Cubo de basura
Ведро

CHROME 545,00



GOLD / BRONZE 655,00



Art. 5351

3-TIER CORNER SHOWER TIDY



Angolare per doccia 3 piani
3-tier corner shower tidy
Coin pour douche 3 plateaux
Eckelement mit 3 ablagen für dusche
Angular para ducha 3 estantes
Уголок душевой с 3 полками

CHROME 305,00



GOLD / BRONZE 700,00



Art. 5347

3-LEGGED STOOL - Ø 32 x h 45 Cm



Sgabello 3 gambe
3-legged stool
Tabouret 3 pieds
Hocker mit 3 beinen
Taburete 3 patas
Табурет на 3 ножках

CHROME 655,00



GOLD / BRONZE 790,00

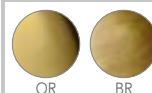

Art. 5340
WALL-MOUNTED MAGNIFYING MIRROR

Specchio ingranditore a parete
 Wall-mounted magnifying mirror
 Miroir agrandisseur mural
 Vergrößerungsspiegel zur wandmontage
 Espejo ampliador de pared
 Зеркало настенное увеличивающее

CHROME 450,00

GOLD / BRONZE 545,00

Art. 5341
WALL-MOUNTED JOINTED MAGNIFYING MIRROR

Specchio ingranditore a parete con CROSS
 Wall-mounted jointed magnifying mirror
 Miroir agrandisseur mural articulé
 Vergrößerungsspiegel zur wandmontage, mit gelenk
 Espejo ampliador de pared con articulación
 Зеркало настенное увеличивающее с шарниром

CHROME 360,00

GOLD / BRONZE 435,00

Art. 5342
LAID-ON MAGNIFYING MIRROR

Specchio ingranditore da appoggio
 Laid-on magnifying mirror
 Miroir agrandisseur à poser
 Vergrößerungsspiegel zum aufstellen
 Espejo ampliador en apoyo
 Зеркало увеличивающее настольное

CHROME 340,00

GOLD / BRONZE 405,00

Art. 5335
IMPERO MIRROR - 70 x 90 Cm

Specchio Impero
 Impero mirror
 Miroir Impero
 Spiegel Impero
 Espejo Impero
 Зеркало Impero

SILVER 655,00

GOLD 780,00

Art. 5336
IMPERO MIRROR - 70 x 120 Cm

Specchio Impero
 Impero mirror
 Miroir Impero
 Spiegel Impero
 Espejo Impero
 Зеркало Impero

SILVER 935,00

GOLD 1.120,00

Art. 5337
TILTING ROUND BEVELLED MIRROR - Ø 50 Cm

Specchio molato basculante tondo
 Tilting round bevelled mirror
 Miroir basculant rond
 Runder Schwenkspiegel
 Espejo basculante redondo
 Круглое откидное зеркало

CHROME 680,00

GOLD / BRONZE 815,00

Art. 5338

ROUND BEVELLED MIRROR - Ø70 Cm



Specchio molato tondo
Round bevelled mirror
Miroir rond
Runder spiegel
Espejo redondo
Зеркало круглое

655,00

Art. 5339

RECTANGULAR REVERSIBLE BEVELLED MIRROR - 65 x 90 Cm



Specchio rettangolare molato reversibile
Rectangular reversible bevelled mirror
Miroir rectangulaire brossé réversible
Rechteckiger geschliffener spiegel, drehbar
Espejo rectangular amolado reversible
Зеркало прямоугольное поворотное с обработанными краями

655,00

Art. 5343

WALL LIGHT WITH BLACK SHADE



Applique con paralume in nastro nero
Wall light with black shade
Applique avec abat-jour en ruban noir
Wandleuchter mit schwarzem Lampenschirm
Lampara con sombra negro
Бра с абажуром из чёрной ткани

CHROME

240,00



GOLD / BRONZE

290,00



Art. 5344

WALL LIGHT WITH WHITE SHADE



Applique con paralume in nastro bianco
Wall light with white shade
Applique avec abat-jour en ruban blanc
Wandleuchter mit weißem Lampenschirm
Lampara con sombra blanco
Бра с абажуром из белой ткани

CHROME

240,00



GOLD / BRONZE

290,00

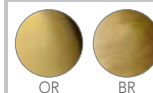

Art. 5345

WALL LIGHT



Applique con ventola
Wall light
Applique
Wandleuchter
Lampara
Бра

CHROME

240,00



GOLD / BRONZE

290,00

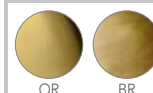

Art. 5346

ADJUSTABLE LED LAMP



Lampada orientabile LED
Adjustable LED lamp
Lampe orientable LED
Schwenkbare LED-leuchte
Lámpara orientable LED
Светильник направленный светодиодный

CHROME

320,00



GOLD / BRONZE

385,00

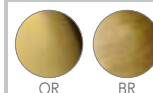



BUTTERFLY HUNG WC
Art. 4006



BUTTERFLY HUNG BIDET
Art. 4007



BUTTERFLY WC
Art. 4008



BUTTERFLY BIDET
Art. 4009



BUTTERFLY 40x40
Art. 4001

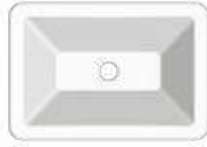

BUTTERFLY 60x40
Art. 4002



BUTTERFLY 50
Art. 4003



BUTTERFLY 70
Art. 4004



BUTTERFLY 90
Art. 4005



BUTTERFLY ACCESORIES

Art. 4006

BUTTERFLY HUNG WC - 52,5 x 36,5 Cm - 20 Kg



Wc Sospeso
Wall-mounted WC
Cuvette suspendue
Hänge-WC
Inodoro suspendido
Унитаз подвесной



WHITE

360,00



52,5

36,5



#

42

Senza staffe - Aggiungere fissaggio rapido
Without fixing set - Add quick fixing kit
Sans équerres - Ajouter fixation rapide
Ohne Befestigungselemente und Bügel - Schnellverbindung hinzufügen
Sin soportes - Añadir fijación rápida
Без скоб - Дополнительное набор быстрого монтажа

PALLET QUANTITY - 100x120x200h: 20+CW

PALLET QUANTITY - 80x120x200h: 14+CW

BIOKER + 115,00

Art. 4007

BUTTERFLY HUNG BIDET - 52,5 x 36,5 Cm - 20 Kg



Bidet sospeso
Wall-mounted bidet
Bidet suspendu
Hänge-Bidet
Bidet suspendido
Биде подвесное

WHITE

360,00



52,5

36,5



#

42

Senza staffe - Aggiungere fissaggio rapido
Borchia troppo pieno compresa
Without fixing set - Add quick fixing kit
Overflow cap included
Sans équerres - Ajouter fixation rapide
Anneau trop-plein inclus
Ohne Befestigungselemente und Bügel - Schnellverbindung hinzufügen
Beschlag für Überlaufschutz inklusive
Sin soportes - Añadir fijación rápida
Tachón rebosadero incluido
Без скоб - Дополнительное набор быстрого монтажа
Перелив входит в комплект

PALLET QUANTITY - 100x120x200h: 25

PALLET QUANTITY - 80x120x200h: 16

BIOKER + 115,00

+ Art. 10050/A - STANDARD

20,00

+ Art. 10050/B - WB9 2.0 CLICK SYSTEM

25,00



Fissaggio Rapido per Sanitari
Quick fixing kit for sanitary fittings
Fixation rapide pour sanitaires
Schnellverbindung für Sanitäreanlagen
Fijación rápida para sanitarios
Набор быстрого монтажа для сантехники



Fissaggio Rapido per Sanitari
Quick fixing kit for sanitary fittings
Fixation rapide pour sanitaires
Schnellverbindung für Sanitäreanlagen
Fijación rápida para sanitarios
Набор быстрого монтажа для сантехники

Art. 4008

BUTTERFLY WC - 52,5 x 36,5 Cm - 22 Kg



Wc a terra
Floor-mounted wc
Cuvette au sol
Bodenstehendes wc
Inodoro a tierra
Унитаз напольный



WHITE

360,00



Borchia troppo pieno compresa
Overflow cap included
Anneau trop-plein inclus
Beschlag für Überlaufschutz inklusive
Tachón rebosadero incluido
Перелив входит в комплект



PALLET QUANTITY - 100x120x200h: 15+CW
PALLET QUANTITY - 80x120x200h: 14+CW

BIOKER + 115,00

Art. 4009

BUTTERFLY BIDET - 52,5 x 36,5 Cm - 22 Kg



Bidet a terra
Floor-mounted bidet
Bidet au sol
Bodenstehendes Bidet
Bidet a tierra
Биде напольное

WHITE

360,00



Borchia troppo pieno compresa
Overflow cap included
Anneau trop-plein inclus
Beschlag für Überlaufschutz inklusive
Tachón rebosadero incluido
Перелив входит в комплект



PALLET QUANTITY - 100x120x200h: 20
PALLET QUANTITY - 80x120x200h: 16

BIOKER + 115,00

Art. 4010/A

BUTTERFLY SEAT COVER

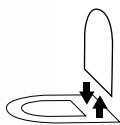

Sedile per Wc in termoindurente
Seat cover Wc in thermosetting resin
Abattant wc en matière thermodurcissable
WC-deckel Duroplax
Asiento para inodoro en material termoenduracido
Сиденье унитаза из термореактивного полимера

WHITE

140,00

Con cerniere cromate - Sgancio rapido
With chromed Kit - Rapid lift system
Charnières chromées - Décrochage rapide
Mit scharniere chrom - Schnellbefestigung
Bisagras cromadas - Desenganche rápido
С хромированными шарнирами - Быстрое отсоединение

Art. 4010/B

BUTTERFLY SEAT COVER

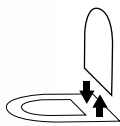

Sedile per Wc in termoindurente
Seat cover Wc in thermosetting resin
Abattant wc en matière thermodurcissable
WC-deckel Duroplax
Asiento para inodoro en material termoenduracido
Сиденье унитаза из термореактивного полимера

WHITE

185,00

Con cerniere cromate - Sgancio rapido
With chromed Kit - Rapid lift system
Charnières chromées - Décrochage rapide
Mit scharniere chrom - Schnellbefestigung
Bisagras cromadas - Desenganche rápido
С хромированными шарнирами - Быстрое отсоединение

Art. 10005

FIXING SET



Staffe di montaggio Wc e bidet
Fixing attachments for Wc and bidet
Supports de montage pour cuvette et bidets suspendus
Montagebügel Für Hänge-wc und bidet
Soportes de montaje inodoro y bidé
Монтажные кронштейны для унитаза и биде

--

70,00

Art. 4001

BUTTERFLY 40 x 40 - 40 x 40 Cm - 10 Kg - 5,5 L.



Lavabo da appoggio
Lay-on washbasin
Lavabo à poser
Aufsatzwaschbecken
Lavabo de apoyo
Раковина умывальника накладная

WHITE

310,00



Senza troppo pieno - Consigliata piletta Art. 10034
Without overflow - Waste Art. 10034 recommended
Sans trop-plein - Bonde Art. 10034 conseillée
Ohne überlauf - Abfluss Art. 10034 empfohlen
Sin rebosadero - Recomendado desagüe Art. 10034
Без пробки перелива - Рекомендуется донный клапан арт. 10034

PALLET QUANTITY - 100x120x200h: 64

PALLET QUANTITY - 80x120x200h: 28

BIOKER + 115,00

Art. 4002

BUTTERFLY 60 x 40 - 60 x 42 Cm - 14 Kg - 10 L.



Lavabo da appoggio
Lay-on washbasin
Lavabo à poser
Aufsatzwaschbecken
Lavabo de apoyo
Раковина умывальника накладная

WHITE

340,00

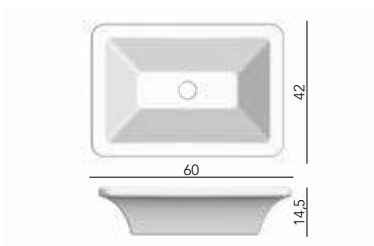

Senza troppo pieno - Consigliata piletta Art. 10034
Without overflow - Waste Art. 10034 recommended
Sans trop-plein - Bonde Art. 10034 conseillée
Ohne überlauf - Abfluss Art. 10034 empfohlen
Sin rebosadero - Recomendado desagüe Art. 10034
Без пробки перелива - Рекомендуется донный клапан арт. 10034

PALLET QUANTITY - 100x120x200h: 40

PALLET QUANTITY - 80x120x200h: 28

BIOKER + 115,00

Art. 4003

BUTTERFLY 50 - 50,5 x 47 Cm - 14 Kg - 2 L.



Lavabo da appoggio o sospeso
Lay-on or wall-mounted washbasin
Lavabo à poser ou suspendu
Aufsatz-oder Hängewaschbecken
Lavabo de apoyo o suspendido
Раковина умывальника накладная или подвесная

WHITE

350,00



Fissaggi a muro compresi - Borchia troppo pieno compresa
Wall attachments included - Overflow cap included
Fixations murales incluses - Anneau trop-plein inclus
Wandbefestigungen inklusive - Beschlag für Überlaufschutz inklusive
Fijación pared incluida - Tachón rebosadero incluido
Настенные крепления входят в комплект - Перелив входит в комплект

PALLET QUANTITY - 100x120x200h: 50

PALLET QUANTITY - 80x120x200h: 28

BIOKER + 115,00

Art. 4004

BUTTERFLY 70 - 70,5 x 46,5 Cm - 17 Kg - 3 L.



Lavabo da appoggio o sospeso

Lay-on or wall-mounted washbasin

Lavabo à poser ou suspendu

Aufsatz-oder Hängewaschbecken

Lavabo de apoyo o suspendido

Раковина умывальника накладная или подвесная

WHITE

420,00



Fissaggi a muro compresi - Borchia troppo pieno compresa

Wall attachments included - Overflow cap included

Fixations murales incluses - Anneau trop-plein inclus

Wandbefestigungen inklusive - Beschlag für Überlaufschutz inklusive

Fijación pared incluida - Tachón rebosadero incluido

Настенные крепления входят в комплект - Перелив входит в комплект

PALLET QUANTITY - 100x120x200h: 30

PALLET QUANTITY - 80x120x200h: 28

BIOKER + 115,00

Art. 4005

BUTTERFLY 90 - 91 x 46,5 Cm - 19 Kg - 3,5 L.



Lavabo da appoggio o sospeso

Lay-on or wall-mounted washbasin

Lavabo à poser ou suspendu

Aufsatz-oder Hängewaschbecken

Lavabo de apoyo o suspendido

Раковина умывальника накладная или подвесная

WHITE

490,00



Fissaggi a muro compresi - Borchia troppo pieno compresa

Wall attachments included - Overflow cap included

Fixations murales incluses - Anneau trop-plein inclus

Wandbefestigungen inklusive - Beschlag für Überlaufschutz inklusive

Fijación pared incluida - Tachón rebosadero incluido

Настенные крепления входят в комплект - Перелив входит в комплект

PALLET QUANTITY - 100x120x200h: 20

PALLET QUANTITY - 80x120x200h: 13

BIOKER + 115,00

Art. 10034



Piletta lavabo da 1"1/4

con troppo pieno integrato

1"1/4 washbasin waste with overflow

Bonde lavabo de 1"1/4 avec trop-plein intégré

Waschbeckenabfluss 1"1/4 mit integriertem Überlaufschutz

Desagüe lavabo de 1"1/4 con rebosadero integrado

Донный клапан для умывальника 1"1/4 с интегрированным переливом

CR

200,00

NROP

220,00

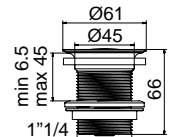

Art. 10010/C



Scarico automatico 1"1/4 click-clack, tappo grande

Automatic pop-waste 1" 1/4 click-clack, big plug

Bonde clic-clac, grand debit

Automatischer ablauf click-clack, crosser stöpsel

Valvula automática 1" 1/4 click-clack, tapón grande

Слив автоматический: клапан 1"1/4, большая пробка

CR / NROP + WHITE **105,00**

ORS + WHITE

145,00

Art. 4012
WALL MOUNTED SOAP DISH - H70 Cm

Porta sapone da muro
 Wall mounted soap dish
 Porte-savon mural
 Seifenschale für Wandmontage
 Porta jabón de pared
 Мыльница настенная

WHITE CHROME
210,00

Art. 4013
WALL MOUNTED TUMBLER - L22 P9 H4,5 Cm

Porta spazzolino da muro
 Wall mounted tumbler
 Porte-brosses à dent mural
 Zahnbürstenbecher für Wandmontage
 Porta cepillo de pared
 Стакан для зубных щеток настенный

WHITE CHROME
210,00

Art. 4015
FREESTANDING TOILET BRUSH - L4,5 P43 H19 Cm

Portascopino da terra
 Freestanding toilet brush
 Porte-balayette au sol
 Freistehender WC-Bürstenständer
 Porta escobilla de suelo
 Туалетный ерш напольный

WHITE CHROME
210,00

Art. 4014
WALL MOUNTED TOILET ROLL HOLDER - L22 P9 H4,5 Cm

Porta rotolo da muro
 Wall mounted toilet roll holder
 Porte-rouleau WC mural
 Toilettenpapierhalter für Wandmontage
 Porta rollo de pared
 Держатель рулона туалетной бумаги настенный

CHROME
175,00

Art. 4016
FLAG-SHAPED TOWEL HOLDER - L4,5 P43 H19 Cm

Porta asciugamani a bandiera
 Flag-shaped towel holder
 Porte-serviettes à deux bras
 2-arm-handtuchhalter
 Toallero giratorio
 Держатель полотенец, спицы

CHROME
395,00

Art. 4017
TOWEL BAR - L40 P9 H4,5 Cm

Porta asciugamani
 Towel bar
 Porte-Serviettes
 Handtuchhalter
 Toallero
 Держатель полотенец

CHROME
265,00

Art. 4018**TOWEL BAR** - L60 P9 H4,5 Cm

Porta asciugamani
Towel bar
Porte-Serviettes
Handtuchhalter
Toallero
Держатель полотенец

CHROME**280,00****Art. 4019****ROBE HOOK** - L8 P9 H4,5 Cm

Appendiabiti
Robe hook
Porte manteau
Kleiderhaken
Perchero
Вешалка для одежды

CHROME**180,00**

Art. 2310

P50 H37 Cm

245,00

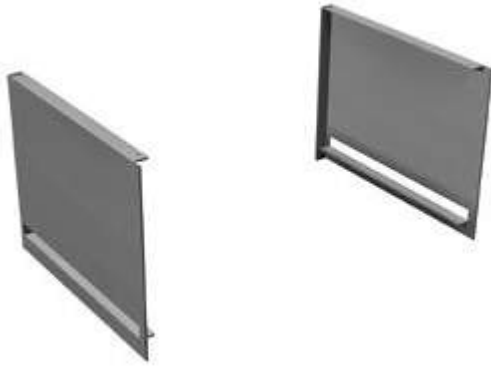

Coppia fianchi
 Pair of sides
 Côté (2 pc)
 Paar Seitenwände
 Par de laterales
 Пара боковых панелей

Art. 2311

P50 H37 Cm

125,00



Fianco singolo per rompitratta
 Single supporting side
 Côté simple pour boîte de jonction
 Einzelne Seitenwand für Stützelement
 Lateral simple de sostén
 Одна боковая панель для опорной поперечины

Art. 2312

L60 P50 H2 Cm

235,00

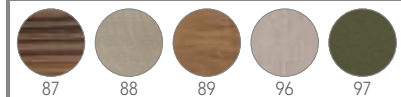

Coppia piano 60 cm
 Pair of 60 cm tops
 Plan 60 cm (2 pc)
 Paar Tops, 60 cm
 Par encimera 60 cm
 Пара столешниц 60 см

- Se non viene specificato il lavabo il top viene inviato senza foro - Se si desidera un foro per un lavabo non in lista il costo extra netto è di Euro 50 - I soli lavabi abbinabili sono quelli nel catalogo Scarabeo 2020, salvo diverse disposizioni
 - If the washbasin is not indicated, the top is shipped without hole - The additional net cost for a hole in a washbasin that is not in the list is Euro 50 - Only the washbasins contained in the Scarabeo 2020 catalogue can be matched, except where otherwise stated
 - Si le type de lavabo n'est pas précisé, le plan est envoyé sans percement - Si vous souhaitez un percement pour un lavabo hors catalogue, 50 euros seront facturés en supplément - Les seuls lavabos combinables sont repris dans le catalogue Scarabeo 2020, sauf mention contraire
 - Bei fehlender Angabe des Modells wird das Waschbecken ohne Bohrung geliefert - Für Bohrungen an Waschbecken, die nicht in der Liste enthalten sind, wird ein Zuschlag von 50 Euro berechnet - Nur die Waschbecken aus dem Katalog Scarabeo 2020 sind kombinierbar, sofern nicht anders angegeben
 - Si no está especificado el lavabo, la encimera se envía sin orificio - Si se desea un orificio para un lavabo que no figura en la lista, el coste extra neto es de 50 euros - Los únicos lavabos instalables son aquellos del catálogo Scarabeo 2020, salvo en caso de disposiciones diferentes
 - Если умывальник не будет указан, столешница будет отправлена без отверстия - Если необходимо выполнить отверстие для умывальника, который не входит в перечень, наценка-нетто составит 50 евро - Сочетаются только умывальники из каталога Scarabeo 2020, за исключением других типов размещения

Art. 2313

L90 P50 H2 Cm



280,00



Coppia piano 90 cm
 Pair of 90 cm tops
 Plan 90 cm (2 pc)
 Paar Tops, 90 cm
 Par encimera 90 cm
 Пара столешниц 90 см

Art. 2314

L120 P50 H2 Cm



335,00



Coppia piano 120 cm
 Pair of 120 cm tops
 Plan 120 cm (2 pc)
 Paar Tops, 120 cm
 Par encimera 120 cm
 Пара столешниц 120 см

Art. 2317/A

L60 P50 H2 Cm



120,00

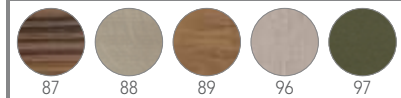

Mensola superiore 60 cm
 Upper shelf 60 cm
 Étagère supérieure 60 cm
 Obere Ablage, 60 cm
 Repisa superior 60 cm
 Верхняя полка 60 см

Art. 2317/B

L60 P45 H2 Cm



120,00

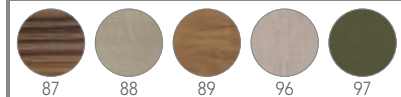

Mensola inferiore 60 cm
 Lower shelf 60 cm
 Étagère inférieure 60 cm
 Untere Ablage, 60 cm
 Repisa inferior 60 cm
 Нижняя полка 60 см

- Se non viene specificato il lavabo il top viene inviato senza foro - Se si desidera un foro per un lavabo non in lista il costo extra netto è di Euro 50 - I soli lavabi abbinabili sono quelli nel catalogo Scarabeo 2020, salvo diverse disposizioni
 - If the washbasin is not indicated, the top is shipped without hole - The additional net cost for a hole in a washbasin that is not in the list is Euro 50 - Only the washbasins contained in the Scarabeo 2020 catalogue can be matched, except where otherwise stated
 - Si le type de lavabo n'est pas précisé, le plan est envoyé sans perçement - Si vous souhaitez un perçement pour un lavabo hors catalogue, 50 euros seront facturés en supplément - Les seuls lavabos combinables sont repris dans le catalogue Scarabeo 2020, sauf mention contraire
 - Bei fehlender Angabe des Modells wird das Waschbecken ohne Bohrung geliefert - Für Bohrungen an Waschbecken, die nicht in der Liste enthalten sind, wird ein Zuschlag von 50 Euro berechnet - Nur die Waschbecken aus dem Katalog Scarabeo 2020 sind kombinierbar, sofern nicht anders angegeben
 - Si no está especificado el lavabo, la encimera se envía sin orificio - Si se desea un orificio para un lavabo que no figura en la lista, el coste extra neto es de 50 euros - Los únicos lavabos instalables son aquellos del catálogo Scarabeo 2020, salvo en caso de disposiciones diferentes
 - Если умывальник не будет указан, столешница будет отправлена без отверстия - Если необходимо выполнить отверстие для умывальника, который не входит в перечень, наценка-нетто составит 50 евро - Сочетаются только умывальники из каталога Scarabeo 2020, за исключением других типов размещения

Art. 2318/A

L90 P50 H2 Cm



140,00

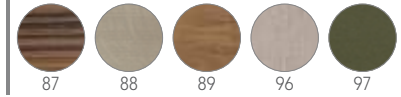

Mensola superiore 90 cm
 Upper shelf 90 cm
 Étagère supérieure 90 cm
 Obere Ablage, 90 cm
 Repisa superior 90 cm
 Верхняя полка 90 см

Art. 2318/B

L90 P45 H2 Cm



140,00

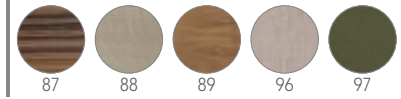

Mensola inferiore 90 cm
 Lower shelf 90 cm
 Étagère inférieure 90 cm
 Untere Ablage, 90 cm
 Repisa inferior 90 cm
 Нижняя полка 90 см

Art. 2319/A

L120 P50 H2 Cm



170,00



Mensola superiore 120 cm
 Upper shelf 120 cm
 Étagère supérieure 120 cm
 Obere Ablage, 120 cm
 Repisa superior 120 cm
 Верхняя полка 120 см

Art. 2319/B

L120 P45 H2 Cm



170,00

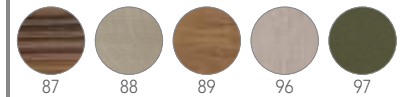

Mensola inferiore 120 cm
 Lower shelf 120 cm
 Étagère inférieure 120 cm
 Untere Ablage, 120 cm
 Repisa inferior 120 cm
 Нижняя полка 120 см

- Se non viene specificato il lavabo il top viene inviato senza foro - Se si desidera un foro per un lavabo non in lista il costo extra netto è di Euro 50 - I soli lavabi abbinabili sono quelli nel catalogo Scarabeo 2020, salvo diverse disposizioni
 - If the washbasin is not indicated, the top is shipped without hole - The additional net cost for a hole in a washbasin that is not in the list is Euro 50 - Only the washbasins contained in the Scarabeo 2020 catalogue can be matched, except where otherwise stated
 - Si le type de lavabo n'est pas précisé, le plan est envoyé sans percement - Si vous souhaitez un percement pour un lavabo hors catalogue, 50 euros seront facturés en supplément - Les seuls lavabos combinables sont repris dans le catalogue Scarabeo 2020, sauf mention contraire
 - Bei fehlender Angabe des Modells wird das Waschbecken ohne Bohrung geliefert - Für Bohrungen an Waschbecken, die nicht in der Liste enthalten sind, wird ein Zuschlag von 50 Euro berechnet - Nur die Waschbecken aus dem Katalog Scarabeo 2020 sind kombinierbar, sofern nicht anders angegeben
 - Si no está especificado el lavabo, la encimera se envía sin orificio - Si se desea un orificio para un lavabo que no figura en la lista, el coste extra neto es de 50 euros - Los únicos lavabos instalables son aquellos del catálogo Scarabeo 2020, salvo en caso de disposiciones diferentes
 - Если умывальник не будет указан, столешница будет отправлена без отверстия - Если необходимо выполнить отверстие для умывальника, который не входит в перечень, наценка-нетто составит 50 евро - Сочетаются только умывальники из каталога Scarabeo 2020, за исключением других типов размещения

Art. 2315

P50 H2 Cm



2,00

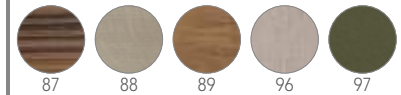

Mensola superiore a cm su misura
Upper shelf to measure (by cm)
Étagère supérieure au cm sur mesure
Obere Ablage, Abmessungen nach Maß
Repisa superior por cm a medida
Верхняя полка за см под заказ

Art. 2316

P45 H2 Cm



2,00

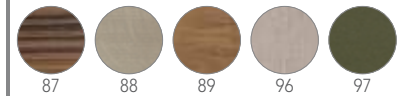

Mensola inferiore a cm su misura
Lower shelf to measure (by cm)
Étagère inférieure au cm sur mesure
Untere Ablage, Abmessungen nach Maß
Repisa inferior por cm a medida
Нижняя полка за см под заказ

Art. 10032

COMPACT TRAP



Sifone compatto in ottone
Brass compact trap
Siphon compact en laiton
Kompakter Siphon aus Messing
Sifón compacto de latón
Компактный сифон из латуни

CR 290,00
NROP 290,00

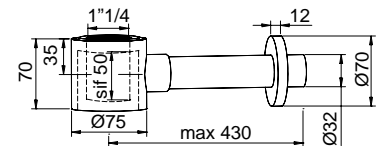

Art. 10009



Sifone tondo in ottone ribassato 1" 1/4 cromato
Cr Brass round trap, shorted 1" 1/4 chromed
Syphon petit culot laiton chromé
Siphon aus verchromtem messing, abgeflacht
Sifón redondo de latón rebajado 1" 1/4 cromado
Сифон круглого сечения 1" 1/4 укороченный, из хромированной латуни

CR 115,00
NROP 170,00
ORS 290,00

- Se non viene specificato il lavabo il top viene inviato senza foro - Se si desidera un foro per un lavabo non in lista il costo extra netto è di Euro 50 - I soli lavabi abbinabili sono quelli nel catalogo Scarabeo 2020, salvo diverse disposizioni
- If the washbasin is not indicated, the top is shipped without hole - The additional net cost for a hole in a washbasin that is not in the list is Euro 50 - Only the washbasins contained in the Scarabeo 2020 catalogue can be matched, except where otherwise stated
- Si le type de lavabo n'est pas précisé, le plan est envoyé sans perçement - Si vous souhaitez un perçement pour un lavabo hors catalogue, 50 euros seront facturés en supplément - Les seuls lavabos combinables sont repris dans le catalogue Scarabeo 2020, sauf mention contraire
- Bei fehlender Angabe des Modells wird das Waschbecken ohne Bohrung geliefert - Für Bohrungen an Waschbecken, die nicht in der Liste enthalten sind, wird ein Zuschlag von 50 Euro berechnet - Nur die Waschbecken aus dem Katalog Scarabeo 2020 sind kombinierbar, sofern nicht anders angegeben
- Si no está especificado el lavabo, la encimera se envía sin orificio - Si se desea un orificio para un lavabo que no figura en la lista, el coste extra neto es de 50 euros - Los únicos lavabos instalables son aquellos del catálogo Scarabeo 2020, salvo en caso de disposiciones diferentes
- Если умывальник не будет указан, столешница будет отправлена без отверстия - Если необходимо выполнить отверстие для умывальника, который не входит в перечень, наценка-нетто составит 50 евро - Сочетаются только умывальники из каталога Scarabeo 2020, за исключением других типов размещения

Art. SLD1



SLIDE COMPOSITION 120_88

910,00

- Art. 2310 _NROP - P50 H37 Cm
- Art. 2314 _88 - L120 P50 H2 Cm
- Art. 2202 - Ø70 Cm

Lavabo escluso
 Washbasin excluded
 Lavabo non compris
 Waschbecken nicht enthalten
 Lavabo excluido
 Раковина умывальника не входит в комплект

GLAM 56 - Art. 1804_52
 56 x 39 Cm - WHITE 365,00 - COLORS 560,00 - DECORLAB 610,00

Art. SLD2



SLIDE COMPOSITION 120_89

910,00

- Art. 2310 _NROP - P50 H37 Cm
- Art. 2314 _89 - L120 P50 H2 Cm
- Art. 2202 - Ø70 Cm

Lavabo escluso
 Washbasin excluded
 Lavabo non compris
 Waschbecken nicht enthalten
 Lavabo excluido
 Раковина умывальника не входит в комплект

GLAM 56 - Art. 1804_55
 56 x 39 Cm - WHITE 365,00 - COLORS 560,00 - DECORLAB 610,00

Art. SLD3



SLIDE COMPOSITION 120B_89

1.105,00

- Art. 2310 _NROP - P50 H37 Cm
- Art. 2311 _NROP - P50 H37 Cm
- Art. 2314 _89 - L120 P50 H2 Cm
- Art. 2205 - 100 x 60 Cm

Lavabo escluso
 Washbasin excluded
 Lavabo non compris
 Waschbecken nicht enthalten
 Lavabo excluido
 Раковина умывальника не входит в комплект

GLAM 56 - Art. 1804_RRM
 56 x 39 Cm - WHITE 365,00 - COLORS 560,00 - DECORLAB 610,00

Art. SLD4

SLIDE COMPOSITION 90_88

775,00



- Art. 2310 _TRT - P50 H37 Cm

- Art. 2313 _88 - L90 P50 H2 Cm

- Art. 2201 - Ø50 Cm

Lavabo escluso
 Washbasin excluded
 Lavabo non compris
 Waschbecken nicht enthalten
 Lavabo excluido
 Раковина умывальника не входит в комплект

GLAM Ø39 - Art. 1807_49
 Ø39 Cm - WHITE 230,00 - COLORS 415,00 - DECORLAB 450,00

FORI PER LAVABI - HOLES FOR WASHBASINS - ORIFICIOS PARA LAVABOS - ОТВЕРСТИЯ ПОД РАКОВИНЫ УМЫВАЛЬНИКА

ART. 2314 = 1200 X 500 mm

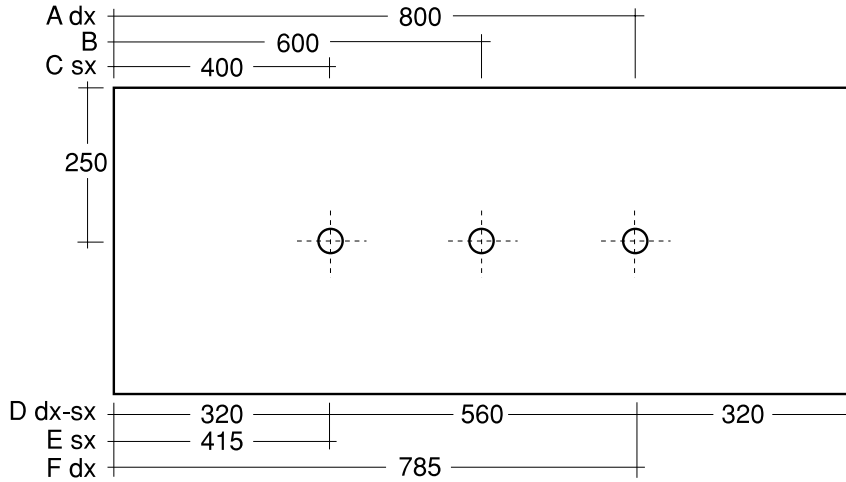

Name	Art.	A dx	B	C sx	D dx-sx
MOON	5501 - 5502 - 5503 - 5504 - 5505 - 5507 - 5508 - 5511 - 5512		■	■	■
MOON	5506 - 5509		■		
BUCKET	8807 - 8808 - 8809 - 8810 - 8811	■	■	■	■
BUTTERFLY	4001 - 4003	■	■	■	■
BUTTERFLY	4002 - 4004 - 4005	■	■	■	
PLANET	8109 - 8111	■	■	■	
PLANET	8110 - 8112	■	■	■	■
MOAI	8601 - 8602 - 8610	■	■	■	
NEXT	8047/A - 8047/B - 8306 - 8307 - 8308	■	■	■	■
TEOREMA 2.0	5101 - 5104 - 5105 - 5110 - 5111 - 5112 - 5114 - 5115 - 5117 - 5118 - 5123	■	■	■	■
TEOREMA 2.0	5108 - 5109		■	■	■
TEOREMA 2.0	5102 - 5106/R-100/A-B - 5119 - 5120 - 5124		■		
TEOREMA	8031 - 8031/R - 8031/R-40 - 8031/R-60 - 8031-40 - 5001 - 5002	■	■	■	■
TEOREMA	8031-60 - 8031/R-80 - 5003	■	■	■	
TEOREMA	8031-80 - 8031/R-100/A-B		■		
GLAM	1806 - 1807 - 1808	■	■	■	■
GLAM	1802 - 1801 - 1803 - 1804 - 1805 - 1810 - 1812	■	■	■	
GLAM	1803		■		
MIZU	9002 - 9004 - 9005 - 9006	■	■	■	■
MIZU	9001 - 9003 - 9007 - 9008	■	■	■	
FUJI	6001 - 6003 - 6013	■	■	■	■
FUJI	6002 - 6004 - 6014 - 6015	■	■	■	
ZEFIRO	8201 - 8204 - 8205 - 8206 - 8207	■	■	■	
THIN-LINE	8046 - 8046/R - 8045	■	■	■	
THIN-LINE	8044 - 8009 - 8009/R - 8010 - 8010/R	■	■	■	■
THIN-LINE	8011 - 8029 - 8029/R - 8030 - 8030/R	■	■	■	■
KONG	8051 - 8051/R	■	■	■	■
KONG	8052 - 8052/R	■	■	■	
KONG	8053 - 8053/R - 8054 - 8054/R		■		
TSUNAMI	8038 - 8038/R		■		
TSUNAMI	8039 - 8039/R	■	■	■	
SHAPE	8098	■	■	■	■
SQUARE	8025/A - 8025/B	■	■	■	
SQUARE	8025/A - 8025/B	■	■	■	■
LAVABI D'ARREDO	8003 - 8034	■	■	■	■

- Se non viene specificato il lavabo il top viene inviato senza foro - Se si desidera un foro per un lavabo non in lista il costo extra netto è di Euro 50 - I soli lavabi abbinabili sono quelli nel catalogo Scarabeo 2020, salvo diverse disposizioni
 - If the washbasin is not indicated, the top is shipped without hole - The additional net cost for a hole in a washbasin that is not in the list is Euro 50 - Only the washbasins contained in the Scarabeo 2020 catalogue can be matched, except where otherwise stated
 - Si le type de lavabo n'est pas précisé, le plan est envoyé sans perçement - Si vous souhaitez un perçement pour un lavabo hors catalogue, 50 euros seront facturés en supplément - Les seuls lavabos combinables sont repris dans le catalogue Scarabeo 2020, sauf mention contraire
 - Bei fehlender Angabe des Modells wird das Waschbecken ohne Bohrung geliefert - Für Bohrungen an Waschbecken, die nicht in der Liste enthalten sind, wird ein Zuschlag von 50 Euro berechnet - Nur die Waschbecken aus dem Katalog Scarabeo 2020 sind kombinierbar, sofern nicht anders angegeben
 - Si no está especificado el lavabo, la encimera se envía sin orificio - Si se desea un orificio para un lavabo que no figura en la lista, el coste extra neto es de 50 euros - Los únicos lavabos instalables son aquellos del catálogo Scarabeo 2020, salvo en caso de disposiciones diferentes
 - Если умывальник не будет указан, столешница будет отправлена без отверстия - Если необходимо выполнить отверстие для умывальника, который не входит в перечень, наценка-нетто составит 50 евро - Сочетаются только умывальники из каталога Scarabeo 2020, за исключением других типов размещения

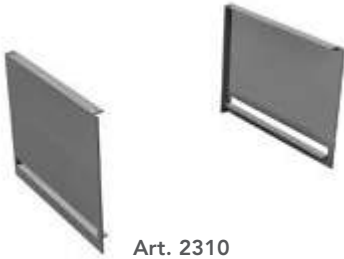

Art. 2310



Art. 2311

SIDES

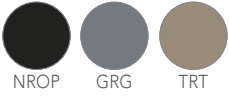

NROP GRG TRT



Art. 2312 - 60 cm ↑ ↓
 Art. 2317/A - 60 cm ↑
 Art. 2317/B - 60 cm ↓



Art. 2313 - 90 cm ↑ ↓
 Art. 2318/A - 90 cm ↑
 Art. 2318/B - 90 cm ↓



Art. 2314 - 120 cm ↑ ↓
 Art. 2319/A - 120 cm ↑
 Art. 2319/B - 120 cm ↓

SHELF



87 88 89 96 97



SHELF 60 cm
 Art. 2310
 Art. 2312



SHELF 90 cm
 Art. 2310
 Art. 2313



SHELF 90 cm
 Art. 2310
 Art. 2313



SHELF 90 cm
 Art. 2310
 Art. 2313



SHELF 120 + 90 cm
 Art. 2310
 Art. 2319/A + 2318/B



SHELF 120 cm
 Art. 2310
 Art. 2314



SHELF 120 cm
 Art. 2310
 Art. 2314



SHELF 120 cm
 Art. 2310 + 2311
 Art. 2314



SHELF 90 cm
Art. 2310
Art. 2313



SHELF 90 cm
Art. 2310
Art. 2313



SHELF 90 cm
Art. 2310
Art. 2313



SHELF 90 + 120 cm
Art. 2310
Art. 2318/A + 2319/B



SHELF 90 + 120 cm
Art. 2310
Art. 2318/A + 2319/B



SHELF 120 + 90 cm
Art. 2310
Art. 2319/A + 2318/B



SHELF 120 cm
Art. 2310
Art. 2314



SHELF 120 cm
Art. 2310
Art. 2314



SHELF 120 cm
Art. 2310
Art. 2314



SHELF 120 cm
Art. 2310 + 2311
Art. 2314



SHELF 120 cm
Art. 2310 + 2311
Art. 2314



SHELF 120 cm
Art. 2310 + 2311
Art. 2314

Art. 2401

L80 P50 H74 Cm



1.185,00

STRUCTURE



WOOD

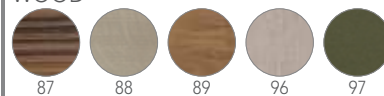

Consolle porta lavabo 80 cm
80 cm washbasin table
Console porte-lavabo 80 cm
Waschtisch 80 cm
Consola para lavabo 80 cm
Консоль для умывальника 80 см

Art. 2402

L100 P50 H74 Cm



1.280,00

STRUCTURE

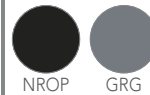

WOOD



Consolle porta lavabo 100 cm
100 cm washbasin table
Console porte-lavabo 100 cm
Waschtisch 100 cm
Consola para lavabo 100 cm
Консоль для умывальника 100 см

Art. 2404

90 x 50 Cm



680,00



Specchio con mensole, Orizzontale / Verticale
Mirror with shelves, Horizontal / Vertical
Miroir avec étagères, horizontale/verticale
Spiegel mit Ablagen, horizontal/vertikal
Espejo con repisas, horizontal/vertical
Зеркало с полками, горизонтальное или вертикальное

- Se non viene specificato il lavabo il top viene inviato senza foro - Se si desidera un foro per un lavabo non in lista il costo extra netto è di Euro 50 - I soli lavabi abbinabili sono quelli nel catalogo Scarabeo 2020, salvo diverse disposizioni
- If the washbasin is not indicated, the top is shipped without hole - The additional net cost for a hole in a washbasin that is not in the list is Euro 50 - Only the washbasins contained in the Scarabeo 2020 catalogue can be matched, except where otherwise stated
- Si le type de lavabo n'est pas précisé, le plan est envoyé sans percement - Si vous souhaitez un percement pour un lavabo hors catalogue, 50 euros seront facturés en supplément - Les seuls lavabos combinables sont repris dans le catalogue Scarabeo 2020, sauf mention contraire
- Bei fehlender Angabe des Modells wird das Waschbecken ohne Bohrung geliefert - Für Bohrungen an Waschbecken, die nicht in der Liste enthalten sind, wird ein Zuschlag von 50 Euro berechnet - Nur die Waschbecken aus dem Katalog Scarabeo 2020 sind kombinierbar, sofern nicht anders angegeben
- Si no está especificado el lavabo, la encimera se envía sin orificio - Si se desea un orificio para un lavabo que no figura en la lista, el coste extra neto es de 50 euros - Los únicos lavabos instalables son aquellos del catálogo Scarabeo 2020, salvo en caso de disposiciones diferentes
- Если умывальник не будет указан, столешница будет отправлена без отверстия - Если необходимо выполнить отверстие для умывальника, который не входит в перечень, наценка-нетто составит 50 евро - Сочетаются только умывальники из каталога Scarabeo 2020, за исключением других типов размещения

Art. 2403

90 x 50 Cm



Specchio senza mensole, Orizzontale / Verticale
 Mirror without shelves, Horizontal / Vertical
 Miroir sans étagères, horizontale/verticale
 Spiegel ohne Ablagen, horizontal/vertikal
 Espejo sin repisas, horizontal/vertical
 Зеркало без полок, горизонтальное или вертикальное

570,00



Art. 2713

L30 Cm



Porta asciugamani con mensola in ceramica 30 cm
 Towel rail with ceramic shelf 30 cm
 Porte-serviettes avec étagère en céramique 30 cm
 Handtuchhalter mit Ablage aus Keramik 30 cm
 Toallero con repisa de cerámica 30 cm
 Держатель полотенец с керамической полкой 30 см

METAL ACCS / NROP / ORS +

WHITE 220,00

250,00

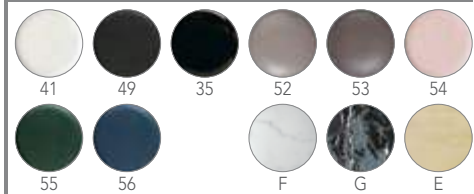

Art. 2714

L45 Cm

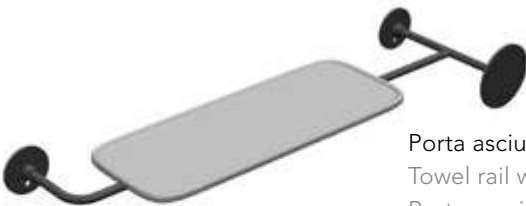

Porta asciugamani con mensola in ceramica 45 cm
 Towel rail with ceramic shelf 45 cm
 Porte-serviettes avec étagère en céramique 45 cm
 Handtuchhalter mit Ablage aus Keramik 45 cm
 Toallero con repisa de cerámica 45 cm
 Держатель полотенец с керамической полкой 45 см

METAL ACCS / NROP / ORS +

WHITE 240,00

280,00

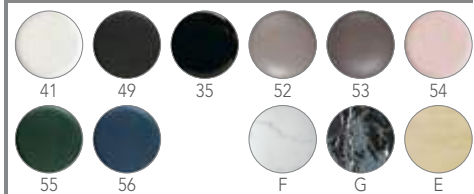

Art. 10032

COMPACT TRAP



Sifone compatto in ottone
 Brass compact trap
 Siphon compact en laiton
 Kompakter Siphon aus Messing
 Sifón compacto de latón
 Компактный сифон из латуни

CR 290,00

NROP 290,00

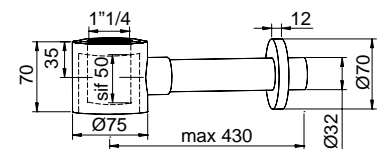

Art. 10009



Sifone tondo in ottone ribassato 1" 1/4 cromato
 Cp Brass round trap, shorted 1" 1/4 chromed
 Syphon petit culot laiton chromé
 Siphon aus verchromtem messing, abgeflacht
 Sifón redondo de latón rebajado 1" 1/4 cromado
 Сифон круглого сечения 1" 1/4 укороченный, из хромированной латуни

CR 115,00

NROP 170,00

ORS 290,00

Art. AB1



ABLE COMPOSITION 100G_88

2.210,00

- Art. 2402 _GRG _88 - L100 P50 H74 Cm
- Art. 2404 _NROP - 90 x 50 Cm
- Art. 2713 _NROP _49 - L30 Cm

Lavabo escluso
Washbasin excluded
Lavabo non compris
Waschbecken nicht enthalten
Lavabo excluido
Раковина умывальника не входит в комплект

GLAM 56 - Art. 1804_RRM
56 x 39 Cm - WHITE 365,00 - COLORS 560,00 - DECORLAB / DECORART 610,00

Art. AB2

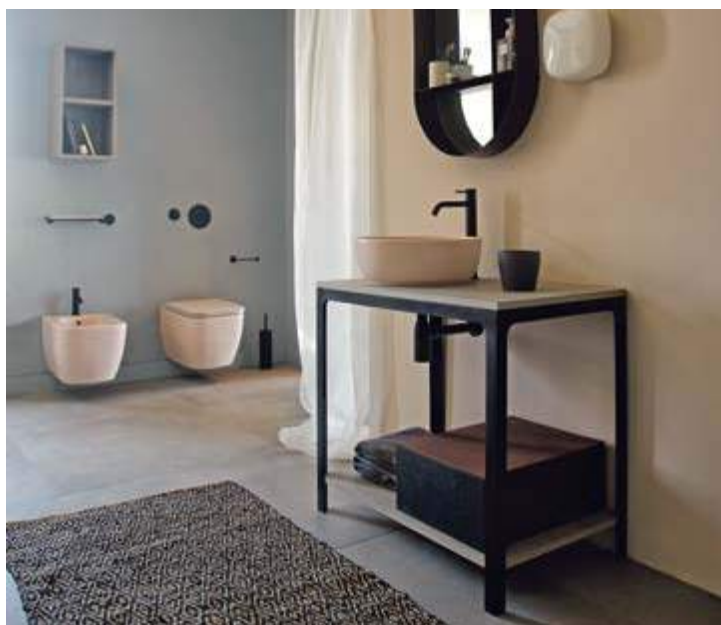

ABLE COMPOSITION 80N_88

1.865,00

- Art. 2401 _NROP _88 - L80 P50 H74 Cm
- Art. 2404 _NROP - 90 x 50 Cm

Lavabo escluso
Washbasin excluded
Lavabo non compris
Waschbecken nicht enthalten
Lavabo excluido
Раковина умывальника не входит в комплект

GLAM Ø39 - Art. 1807_54
Ø39 Cm - WHITE 230,00 - COLORS 415,00 - DECORLAB / DECORART 450,00

Art. AB3



ABLE COMPOSITION 80N_88

1.865,00

- Art. 2401 _NROP _88 - L80 P50 H74 Cm
- Art. 2404 _NROP - 90 x 50 Cm

Lavabo escluso
Washbasin excluded
Lavabo non compris
Waschbecken nicht enthalten
Lavabo excluido
Раковина умывальника не входит в комплект

GLAM 56 - Art. 1804_55
56 x 39 Cm - WHITE 365,00 - COLORS 560,00 - DECORLAB / DECORART 610,00

ART. 2402 = 1000 X 500 mm

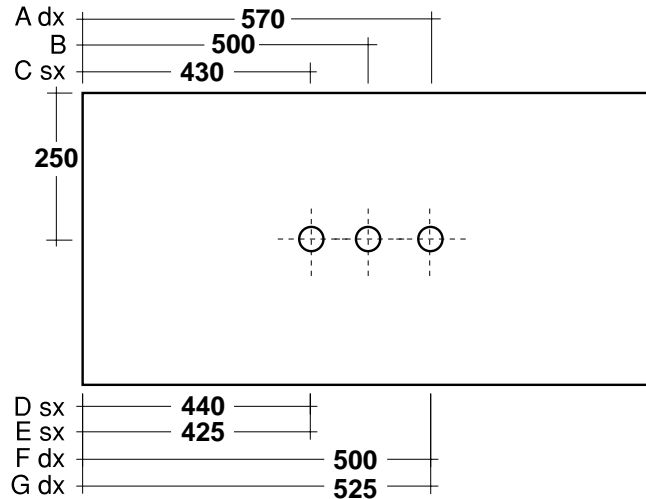

Name	Art.	A dx	B	C sx	D sx	E sx	F dx	G dx
MOON	5501 - 5503 - 5504 - 5507 - 5511	■	■	■				
MOON	5502 - 5505 - 5506 - 5508 - 5509 - 5512		■					
BUCKET	8807 - 8808 - 8809 - 8810 - 8811	■	■	■				
BUTTERFLY	4001 - 4002 - 4003 - 4004	■	■	■				
PLANET	8109 - 8110 - 8111 - 8112	■	■	■				
MOAI	8601 - 8602 - 8610	■	■	■				
NEXT	8047/A - 8047/B - 8306 - 8307 - 8308	■	■	■				
TEOREMA 2.0	5101 - 5108 - 5109 - 5104 - 5105 - 5111 - 5112 - 5114 - 5117	■	■	■				
TEOREMA 2.0	5102 - 5110 - 5115 - 5118 - 5123		■					
TEOREMA	8031 - 8031/R - 8031/R-60 - 8031-40 - 5001 - 5002	■	■	■				
TEOREMA	8031-60 - 8031/R80 - 8031-80 - 5003		■					
GLAM	1802 - 1804 - 1805 - 1810 - 1811	■	■	■				
GLAM	1806 - 1807 - 1808	■	■	■				
GLAM	1801 - 1803 - 1812 - 1813		■		■		■	
MIZU	9001 - 9002 - 9003 - 9004 - 9005 - 9006 - 9007 - 9008	■	■	■				
FUJI	6001 - 6002 - 6003 - 6004 - 6013 - 6014 - 6015	■	■	■				
ZEFIRO	8201 - 8204 - 8205 - 8206 - 8207	■	■	■				
THIN-LINE	8046 - 8046/R - 8045 - 8044 - 8009 - 8009/R	■	■	■				
THIN-LINE	8010 - 8010/R - 8011 - 8029 - 8029/R - 8030 - 8030/R	■	■	■				
KONG	8051 - 8051/R - 8052 - 8052/R	■	■	■				
KONG	8053 - 8053/R		■					
TSUNAMI	8039 - 8039/R	■	■	■				
TSUNAMI	8038 - 8038/R		■					
SHAPE	8098	■	■	■				
SQUARE	8025/A		■			■		■
SQUARE	8025/B	■	■	■				
LAVABI D'ARREDO	8003 - 8034	■	■	■				

- Se non viene specificato il lavabo il top viene inviato senza foro - Se si desidera un foro per un lavabo non in lista il costo extra netto è di Euro 50 - I soli lavabi abbinabili sono quelli nel catalogo Scarabeo 2020, salvo diverse disposizioni
 - If the washbasin is not indicated, the top is shipped without hole - The additional net cost for a hole in a washbasin that is not in the list is Euro 50 - Only the washbasins contained in the Scarabeo 2020 catalogue can be matched, except where otherwise stated
 - Si le type de lavabo n'est pas précisé, le plan est envoyé sans perçement - Si vous souhaitez un perçement pour un lavabo hors catalogue, 50 euros seront facturés en supplément - Les seuls lavabos combinables sont repris dans le catalogue Scarabeo 2020, sauf mention contraire
 - Bei fehlender Angabe des Modells wird das Waschbecken ohne Bohrung geliefert - Für Bohrungen an Waschbecken, die nicht in der Liste enthalten sind, wird ein Zuschlag von 50 Euro berechnet - Nur die Waschbecken aus dem Katalog Scarabeo 2020 sind kombinierbar, sofern nicht anders angegeben
 - Si no está especificado el lavabo, la encimera se envía sin orificio - Si se desea un orificio para un lavabo que no figura en la lista, el coste extra neto es de 50 euros - Los únicos lavabos instalables son aquellos del catálogo Scarabeo 2020, salvo en caso de disposiciones diferentes
 - Если умывальник не будет указан, столешница будет отправлена без отверстия - Если необходимо выполнить отверстие для умывальника, который не входит в перечень, наценка-нетто составит 50 евро - Сочетаются только умывальники из каталога Scarabeo 2020, за исключением других типов размещения

Art. 2901

L109 P45,5 H77 Cm

695,00



Consolle a terra per lavabo 100 cm
 Floor-standing table for washbasin 100 cm
 Console à poser pour lavabo 100 cm
 Waschtisch, 100 cm
 Consola de suelo para lavabo 100 cm
 Напольная консоль для умывальника 100 см

Art. 2902

L89 P43,5 H77 Cm

665,00



Consolle a terra per lavabo 80 cm
 Floor-standing table for washbasin 80 cm
 Console à poser pour lavabo 80 cm
 Waschtisch, 80 cm
 Consola de suelo para lavabo 80 cm
 Напольная консоль для умывальника 80 см

Art. 2903

L69 P43,5 H77 Cm

580,00



Consolle a terra per lavabo 60 cm
 Floor-standing table for washbasin 60 cm
 Console à poser pour lavabo 60 cm
 Waschtisch, 60 cm
 Consola de suelo para lavabo 60 cm
 Напольная консоль для умывальника 60 см

Art. 2912

L99 P45,5 H2 Cm



165,00



Mensola inferiore per consolle Art. 2901
 Lower shelf for table Art. 2901
 Étagère inférieure pour console Art. 2901
 Untere Ablage für Waschtisch Artikel 2901
 Repisa inferior para consola Art. 2901
 Нижняя полка для консоли арт. 2901

Art. 2913

L79 P43,5 H2 Cm



110,00

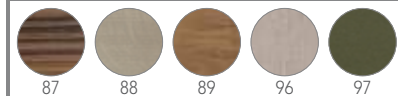

Mensola inferiore per consolle Art. 2902
 Lower shelf for table Art. 2902
 Étagère inférieure pour console Art. 2902
 Untere Ablage für Waschtisch Artikel 2902
 Repisa inferior para consola Art. 2902
 Нижняя полка для консоли арт. 2902

Art. 2910

L100 P45,5 H2 Cm



165,00



Mensola superiore per consolle Art. 2901
 Upper shelf for table Art. 2901
 Étagère supérieure pour console Art. 2901
 Obere Ablage für Waschtisch Artikel 2901
 Repisa superior para consola Art. 2901
 Верхняя полка для консоли арт. 2901

Art. 2911

L80 P43,5 H2 Cm



110,00

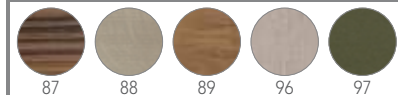

Mensola superiore per consolle Art. 2902
 Upper shelf for table Art. 2902
 Étagère supérieure pour console Art. 2902
 Obere Ablage für Waschtisch Artikel 2902
 Repisa superior para consola Art. 2902
 Верхняя полка для консоли арт. 2902

- Se non viene specificato il lavabo il top viene inviato senza foro - Se si desidera un foro per un lavabo non in lista il costo extra netto è di Euro 50 - I soli lavabi abbinabili sono quelli nel catalogo Scarabeo 2020, salvo diverse disposizioni
 - If the washbasin is not indicated, the top is shipped without hole - The additional net cost for a hole in a washbasin that is not in the list is Euro 50 - Only the washbasins contained in the Scarabeo 2020 catalogue can be matched, except where otherwise stated
 - Si le type de lavabo n'est pas précisé, le plan est envoyé sans percement - Si vous souhaitez un percement pour un lavabo hors catalogue, 50 euros seront facturés en supplément - Les seuls lavabos combinables sont repris dans le catalogue Scarabeo 2020, sauf mention contraire
 - Bei fehlender Angabe des Modells wird das Waschbecken ohne Bohrung geliefert - Für Bohrungen an Waschbecken, die nicht in der Liste enthalten sind, wird ein Zuschlag von 50 Euro berechnet - Nur die Waschbecken aus dem Katalog Scarabeo 2020 sind kombinierbar, sofern nicht anders angegeben
 - Si no está especificado el lavabo, la encimera se envía sin orificio - Si se desea un orificio para un lavabo que no figura en la lista, el coste extra neto es de 50 euros - Los únicos lavabos instalables son aquellos del catálogo Scarabeo 2020, salvo en caso de disposiciones diferentes
 - Если умывальник не будет указан, столешница будет отправлена без отверстия - Если необходимо выполнить отверстие для умывальника, который не входит в перечень, наценка-нетто составит 50 евро - Сочетаются только умывальники из каталога Scarabeo 2020, за исключением других типов размещения

Art. 2905

44 x 20 P45,5 Cm

415,00



- x1 Contenitore metallico profondità 45,5 cm per Art. 2901
- x1 Metal container 45.5 cm depth for Art. 2901
- x1 Caisson métallique profondeur 45,5 cm pour Art. 2901
- x1 Metallbehälter, Tiefe 45,5 cm für Artikel 2901
- x1 Contenedor metálico profundidad 45,5 cm para Art. 2901
- x1 Металлический контейнер глубиной 45,5 см для арт. 2901

Art. 2914

44 x 20 P43,5 Cm

415,00



- x1 Contenitore metallico profondità 43,5 cm per Art. 2902 - Art. 2903
- x1 Metal container 43.5 cm depth for Art. 2902 - Art. 2903
- x1 Caisson métallique profondeur 43,5 cm pour Art. 2902 - Art. 2903
- x1 Metallbehälter, Tiefe 43,5 cm für Artikel 2902 - Art. 2903
- x1 Contenedor metálico profundidad 43,5 cm para Art. 2902 - Art. 2903
- x1 Металлический контейнер глубиной 43,5 см для арт. 2902 - Art. 2903

Art. 2906

L99 P45,5 H20 Cm

670,00

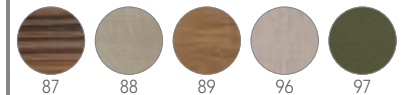

- Cassetto 99 x h20 cm per consolle Art. 2901
- Drawer 99 x h20 cm for table Art. 2901
- Tiroir 99 x h20 cm pour consoles Art. 2901
- Schubfach 99 x h20 cm für Waschtisch Artikel 2901
- Cajón 99 x h20 cm para consola Art. 2901
- Ящик 99 x B20 см для консоли арт. 2901

Art. 2907

L79 P43,5 H20 Cm

625,00

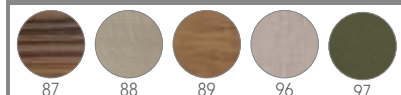

- Cassetto 79 x h20 cm per consolle Art. 2902
- Drawer 79 x h20 cm for table Art. 2902
- Tiroir 79 x h20 cm pour consoles Art. 2902
- Schubfach 79 x h20 cm für Waschtisch Artikel 2902
- Cajón 79 x h20 cm para consola Art. 2902
- Ящик 79 x B20 см для консоли арт. 2902

Art. 2908

L99 P45,5 H30 Cm



Cassetto 99 x h30 cm per consolle Art. 2901
 Drawer 99 x h30 cm for table Art. 2901
 Tiroir 99 x h30 cm pour consoles Art. 2901
 Schubfach 99 x h30 cm für Waschtisch Artikel 2901
 Cajón 99 x h30 cm para consola Art. 2901
 Ящик 99 x В30 см для консоли арт. 2901

725,00



COLORS

975,00

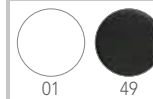

Art. 2909

L79 P43,5 H30 Cm



Cassetto 79 x h30 cm per consolle Art. 2902
 Drawer 79 x h30 cm for table Art. 2902
 Tiroir 79 x h30 cm pour consoles Art. 2902
 Schubfach 79 x h30 cm für Waschtisch Artikel 2902
 Cajón 79 x h30 cm para consola Art. 2902
 Ящик 79 x В30 см для консоли арт. 2902

670,00

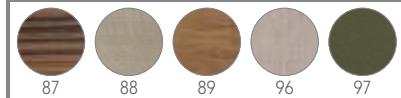

COLORS

850,00



Art. 2916

L59 P43,5 H30 Cm



Cassetto 59 x h30 cm per consolle Art. 2903
 Drawer 59 x h30 cm for table Art. 2903
 Tiroir 59 x h30 cm pour consoles Art. 2903
 Schubfach 59 x h30 cm für Waschtisch Artikel 2903
 Cajón 59 x h30 cm para consola Art. 2903
 Ящик 59 x В30 см для консоли арт. 2903

600,00

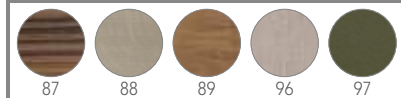

COLORS

790,00



Art. 10032

COMPACT TRAP



Sifone compatto in ottone
 Brass compact trap
 Siphon compact en laiton
 Kompakter Siphon aus Messing
 Sifón compacto de latón
 Компактный сифон из латуни

CR 290,00

NROP 290,00

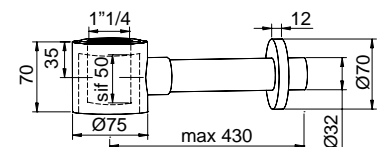

Art. 10009



Sifone tondo in ottone ribassato 1" 1/4 cromato
 Cp Brass round trap, shorted 1" 1/4 chromed
 Syphon petit culot laiton chromé
 Siphon aus verchromtem messing, abgeflacht
 Sifón redondo de latón rebajado 1" 1/4 cromado
 Сифон круглого сечения 1"1/4 укороченный, из хромированной латуни

CR 115,00

NROP 170,00

ORS 290,00

Art. SOL1



SOLID COMPOSITION 89 _89

2.035,00

- Art. 2902 _NROP - L89 P43,5 H77 Cm
- Art. 2907 _89 - L79 P43,5 H20 Cm
- Art. 2914 _NROP - 44 x 20 P43,5 Cm
- Art. 2202 - Ø70 Cm

Lavabo escluso
Washbasin excluded
Lavabo non compris
Waschbecken nicht enthalten
Lavabo excludido
Раковина умывальника не входит в комплект

TEOREMA 2.0 80 SHELF DX® - Art. 5115_54
81 x 44 Cm - WHITE 515,00 - COLORS 715,00 - DECORLAB / DECORART 750,00

Art. SOL2



SOLID COMPOSITION 89 _89

1.955,00

- Art. 2902 _NROP - L89 P43,5 H77 Cm
- Art. 2907 _89 - L79 P43,5 H20 Cm
- Art. 2914 _NROP - 44 x 20 P43,5 Cm
- Art. 2201 - Ø50 Cm

Lavabo escluso
Washbasin excluded
Lavabo non compris
Waschbecken nicht enthalten
Lavabo excludido
Раковина умывальника не входит в комплект

TEOREMA 2.0 80 SHELF DX® - Art. 5115_55
81 x 44 Cm - WHITE 515,00 - COLORS 715,00 - DECORLAB / DECORART 750,00

Art. SOL3



SOLID COMPOSITION 109 _86

2.140,00

- Art. 2901 _NROP - L109 P45,5 H77 Cm
- Art. 2906 _87 - L99 P45,5 H20 Cm
- Art. 2905 _NROP - 44 x 20 P45,5 Cm
- Art. 2204 - 80 x 60 Cm

Lavabo escluso
Washbasin excluded
Lavabo non compris
Waschbecken nicht enthalten
Lavabo excludido
Раковина умывальника не входит в комплект

TEOREMA 2.0 100 SHELF DX® - Art. 5119_41
101 x 46 Cm - WHITE 630,00 - COLORS 830,00 - DECORART 850,00

Art. SOL4



SOLID COMPOSITION 109

2.185,00

- Art. 2901 _NROP - L109 P45,5 H77 Cm
- Art. 2912 + 2910 _88 - L99 P45,5 H2 Cm
- Art. 2905 _NROP - 44 x 20 P45,5 Cm - x2
- Art. 2202 - Ø70 Cm

Lavabo escluso
Washbasin excluded
Lavabo non compris
Waschbecken nicht enthalten
Lavabo excludido
Раковина умывальника не входит в комплект

GLAM 76 - Art. 1803_49
76 x 39 Cm - WHITE 410,00 - COLORS 625,00 - DECORART 700,00

Art. SOL5



SOLID COMPOSITION 109 _88

2.400,00

- Art. 2901 _NROP - L109 P45,5 H77 Cm
- Art. 2910 _88 - L100 P45,5 H2 Cm
- Art. 2908 _88 - L99 P45,5 H30 Cm
- Art. 2905 _NROP - 44 x 20 P45,5 Cm
- Art. 2205 - 100 x 60 Cm

Lavabo escluso
Washbasin excluded
Lavabo non compris
Waschbecken nicht enthalten
Lavabo excludido
Раковина умывальника не входит в комплект

GLAM 56 - Art. 1804_52
56 x 39 Cm - WHITE 365,00 - COLORS 560,00 - DECORLAB / DECORART 610,00

Art. SOL6



SOLID COMPOSITION 100 _89

1.830,00

- Art. 2906 _89 - L99 P45,5 H20 Cm
- Art. 2905 _NROP - 44 x 20 P45,5 Cm - x2
- Art. 2202 - Ø70 Cm

Lavabo escluso
Washbasin excluded
Lavabo non compris
Waschbecken nicht enthalten
Lavabo excludido
Раковина умывальника не входит в комплект

TEOREMA 2.0 60 SHELF DX® - Art. 5114_52
60 x 44 Cm - WHITE 470,00 - COLORS 670,00 - DECORLAB / DECORART 700,00

Art. SOL21

SOLID COMPOSITION 690 _01



1.680,00

- Art. 2903 _ORS - L69 P43,5 H77 Cm
- Art. 2916 _01 - L59 P43,5 H30 Cm
- Art. 2203 - 60 x 60 Cm

Lavabo escluso
 Washbasin excluded
 Lavabo non compris
 Waschbecken nicht enthalten
 Lavabo excluido
 Раковина умывальника не входит в комплект

TEOREMA 2.0 60R - Art. 5105 _41
 60 x 46 Cm - WHITE 470,00 - COLORS 670,00 - DECORLAB / DECORART 700,00

Art. SOL22

SOLID COMPOSITION 69N _49



1.700,00

- Art. 2903 _NROP - L69 P43,5 H77 Cm
- Art. 2916 _49 - L59 P43,5 H30 Cm
- Art. 2202 - Ø70 Cm

Lavabo escluso
 Washbasin excluded
 Lavabo non compris
 Waschbecken nicht enthalten
 Lavabo excluido
 Раковина умывальника не входит в комплект

TEOREMA 2.0 60R - Art. 5105 _49
 60 x 46 Cm - WHITE 470,00 - COLORS 670,00 - DECORLAB / DECORART 700,00

Art. SOL23

SOLID COMPOSITION 69N _01



1.620,00

- Art. 2903 _NROP - L69 P43,5 H77 Cm
- Art. 2916 _01 - L59 P43,5 H30 Cm
- Art. 2201 - Ø50 Cm

Lavabo escluso
 Washbasin excluded
 Lavabo non compris
 Waschbecken nicht enthalten
 Lavabo excluido
 Раковина умывальника не входит в комплект

TEOREMA 2.0 60 SHELF DX® - Art. 5114 _41
 60 x 44 Cm - WHITE 470,00 - COLORS 670,00 - DECORLAB / DECORART 700,00

Art. SOL24

SOLID COMPOSITION 69N_01b



1.680,00

- Art. 2903 _NROP - L69 P43,5 H77 Cm
- Art. 2916 _01 - L59 P43,5 H30 Cm
- Art. 2203 - 60 x 60 Cm

Lavabo escluso
Washbasin excluded
Lavabo non compris
Waschbecken nicht enthalten
Lavabo excluido
Раковина умывальника не входит в комплект

TEOREMA 2.0 60R - Art. 5105 _35
60 x 46 Cm - WHITE 470,00 - COLORS 670,00 - DECORLAB / DECORART 700,00

Art. SOL25

SOLID COMPOSITION 69N _F



1.680,00

- Art. 2903 _NROP - L69 P43,5 H77 Cm
- Art. 2916 _01 - L59 P43,5 H30 Cm
- Art. 2203 - 60 x 60 Cm

Lavabo escluso
Washbasin excluded
Lavabo non compris
Waschbecken nicht enthalten
Lavabo excluido
Раковина умывальника не входит в комплект

TEOREMA 2.0 60 SHELF DX® - Art. 5114 _F
60 x 44 Cm - WHITE 470,00 - COLORS 670,00 - DECORLAB / DECORART 700,00

Art. SOL26

SOLID COMPOSITION 69N _E



1.680,00

- Art. 2903 _NROP - L69 P43,5 H77 Cm
- Art. 2916 _49 - L59 P43,5 H30 Cm
- Art. 2203 - 60 x 60 Cm

Lavabo escluso
Washbasin excluded
Lavabo non compris
Waschbecken nicht enthalten
Lavabo excluido
Раковина умывальника не входит в комплект

TEOREMA 2.0 60 SHELF DX® - Art. 5114 _F
60 x 44 Cm - WHITE 470,00 - COLORS 670,00 - DECORLAB / DECORART 700,00

FORI PER LAVABI - HOLES FOR WASHBASINS - ORIFICIOS PARA LAVABOS - ОТВЕРСТИЯ ПОД РАКОВИНЫ УМЫВАЛЬНИКА

ART. 2901 = 1000 X 455 mm

Name	Art.
TEOREMA 2.0	5106/A - 5106/B - 5119 - 5120 - 5124

FORI PER LAVABI - HOLES FOR WASHBASINS - ORIFICIOS PARA LAVABOS - ОТВЕРСТИЯ ПОД РАКОВИНЫ УМЫВАЛЬНИКА

ART. 2901 + 2910 = 1000 X 455 mm

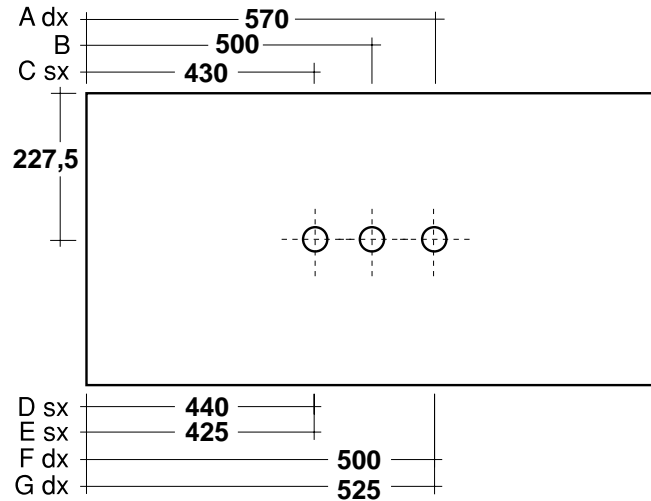

Name	Art.	A dx	B	C sx	D sx	E sx	F dx	G dx
MOON	5501 - 5503 - 5504 - 5507 - 5511	■	■	■				
MOON	5502 - 5505 - 5506 - 5508 - 5509 - 5512		■					
BUCKET	8807 - 8808 - 8809 - 8810 - 8811	■	■	■				
BUTTERFLY	4001 - 4002 - 4003 - 4004	■	■	■				
PLANET	8109 - 8110 - 8111 - 8112	■	■	■				
MOAI	8601 - 8602 - 8610	■	■	■				
NEXT	8047/A - 8047/B - 8306 - 8307 - 8308	■	■	■				
TEOREMA 2.0	5101 - 5108 - 5109 - 5104 - 5105 - 5111 - 5112 - 5114 - 5117	■	■	■				
TEOREMA 2.0	5102 - 5110 - 5115 - 5118 - 5123		■					
TEOREMA	8031 - 8031/R - 8031/R-60 - 8031-40 - 5001 - 5002	■	■	■				
TEOREMA	8031-60 - 8031/R80 - 8031-80 - 5003		■					
GLAM	1802 - 1804 - 1805 - 1810 - 1811	■	■	■				
GLAM	1806 - 1807 - 1808	■	■	■				
GLAM	1801 - 1803 - 1812 - 1813		■		■		■	
MIZU	9001 - 9002 - 9003 - 9004 - 9005 - 9006 - 9007 - 9008	■	■	■				
FUJI	6001 - 6002 - 6003 - 6004 - 6013 - 6014 - 6015	■	■	■				
ZEFIRO	8201 - 8204 - 8205 - 8206 - 8207	■	■	■				
THIN-LINE	8046 - 8046/R - 8045 - 8044 - 8009 - 8009/R	■	■	■				
THIN-LINE	8010 - 8010/R - 8011 - 8029 - 8029/R - 8030 - 8030/R	■	■	■				
KONG	8051 - 8051/R - 8052 - 8052/R	■	■	■				
KONG	8053 - 8053/R		■					
TSUNAMI	8039 - 8039/R	■	■	■				
TSUNAMI	8038 - 8038/R		■					
SHAPE	8098	■	■	■				
SQUARE	8025/A		■			■		■
SQUARE	8025/B	■	■	■				
LAVABI D'ARREDO	8003 - 8034	■	■	■				

- Se non viene specificato il lavabo il top viene inviato senza foro - Se si desidera un foro per un lavabo non in lista il costo extra netto è di Euro 50 - I soli lavabi abbinabili sono quelli nel catalogo Scarabeo 2020, salvo diverse disposizioni
 - If the washbasin is not indicated, the top is shipped without hole - The additional net cost for a hole in a washbasin that is not in the list is Euro 50 - Only the washbasins contained in the Scarabeo 2020 catalogue can be matched, except where otherwise stated
 - Si le type de lavabo n'est pas précisé, le plan est envoyé sans perçement - Si vous souhaitez un perçement pour un lavabo hors catalogue, 50 euros seront facturés en supplément - Les seuls lavabos combinables sont repris dans le catalogue Scarabeo 2020, sauf mention contraire
 - Bei fehlender Angabe des Modells wird das Waschbecken ohne Bohrung geliefert - Für Bohrungen an Waschbecken, die nicht in der Liste enthalten sind, wird ein Zuschlag von 50 Euro berechnet - Nur die Waschbecken aus dem Katalog Scarabeo 2020 sind kombinierbar, sofern nicht anders angegeben
 - Si no está especificado el lavabo, la encimera se envía sin orificio - Si se desea un orificio para un lavabo que no figura en la lista, el coste extra neto es de 50 euros - Los únicos lavabos instalables son aquellos del catálogo Scarabeo 2020, salvo en caso de disposiciones diferentes
 - Если умывальник не будет указан, столешница будет отправлена без отверстия - Если необходимо выполнить отверстие для умывальника, который не входит в перечень, наценка-нетто составит 50 евро - Сочетаются только умывальники из каталога Scarabeo 2020, за исключением других типов размещения

SOLID con lavabo Teorema 2.0
 SOLID with Teorema 2.0 washbasin
 SOLID avec lavabo Teorema 2.0
 SOLID mit Waschbecken Teorema 2.0
 SOLID con lavabo Teorema 2.0
 SOLID с умывальником Теорема 2.0

60 cm = Art: 5105 - 5114 - 5117
 80 cm = Art: 5110 - 5115 - 5118 - 5123
 100 cm = Art: 5106/R-100/A - 5106/R-100/B - 5119 - 5120 - 5124



SOLID con mensola superiore e lavabo generico*
 SOLID with upper shelf and generic washbasin*
 SOLID avec tablette supérieure et lavabo générique*
 SOLID mit Ablage oben und Standardwaschbecken*
 SOLID con repisa superior y lavabo genérico*
 SOLID с верхней полкой и стандартным умывальником*



Art. 2901 - 100 cm



Art. 2902 - 80 cm



Art. 2903 - 60 cm



Art. 2905 - p 45,5 cm



Art. 2914 - p 43,5 cm

CONSOLE / METAL CONTAINER



NROP GRG TRT ORS



Art. 2906 - 99 x h20



Art. 2908 - 99 x h30



Art. 2907 - 79 x h20



Art. 2909 - 79 x h30



Art. 2916 - 59 x h30



Art. 2912 - 99 cm ↓



Art. 2910 - 100 cm ↑



Art. 2913 - 79 cm ↓



Art. 2911 - 80 cm ↑

WOODEN DRAWER / SHELF

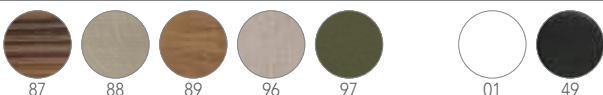

87 88 89 96 97 01 49

* vedi list pag. 224/225 - see list on page 224/225 - voir catalogue p. 224/225 - siehe Preisliste Seite 224/225 - ver lista pág. 224/225 - см. список стр. 224/225



Art. 2901
Art. 2912
Art. 2905



Art. 2901
Art. 2906



Art. 2901 + Art. 2910
Art. 2912
Art. 2905



Art. 2901 + Art. 2910
Art. 2906



Art. 2901
Art. 2906
Art. 2905



Art. 2901
Art. 2906
2x Art. 2905



Art. 2901 + Art. 2910
Art. 2906
Art. 2905



Art. 2901 + Art. 2910
Art. 2906
2x Art. 2905



Art. 2901
Art. 2908



Art. 2901
Art. 2908
Art. 2905



Art. 2901 + Art. 2910
Art. 2908



Art. 2901 + Art. 2910
Art. 2908
Art. 2905

Art. 2501

Ø52 H76 Cm

1.050,00



WOOD



98

CERAMIC



41



49



35



52



53



54



55



56

Consolle completa (gambe legno, snodo e piano in ceramica) tinta legno chiaro

Complete table (wooden legs, joint and ceramic top) light-coloured wooden finish

Console complète (pieds bois, articulation et plan en céramique) teintée bois clair

Komplett-Waschtisch (Beine aus Holz, Gelenk und Top aus Keramik), helle Holzfarbe

Consola completa (patas de madera, articulación y encimera de cerámica) color madera claro

Консоль полностью (деревянные ножки, крестовина и столешница из керамики) в цвете светлого дерева

Art. 2502

Ø52 H76 Cm

1.150,00



WOOD



99

CERAMIC



41



49



35



52



53



54



55



56

Consolle completa (gambe legno, snodo e piano in ceramica) tinta legno scuro

Complete table (wooden legs, joint and ceramic top) dark-coloured wooden finish

Console complète (pieds bois, articulation et plan en céramique) teinte bois foncé

Komplett-Waschtisch (Beine aus Holz, Gelenk und Top aus Keramik), dunkel Holzfarbe

Consola completa (patas de madera, articulación y encimera de cerámica) color madera oscuro

Консоль полностью (деревянные ножки, крестовина и столешница из керамики) окраска под темное дерево

Art. 2504

L52 P40 H47 Cm



Tavolo completo (gambe e piano in legno, snodo in ceramica)

Complete table (legs and wooden top, ceramic joint)

Table complète (pieds et plan en bois, articulation en céramique)

Komplett-Tisch (Beine und Platte aus Holz, Gelenk aus Keramik),

Mesa completa (patas y encimera de madera, articulación de cerámica)

Стол полностью (ножки и столешница из дерева, крестовина из керамики)

840,00

WOOD



CERAMIC

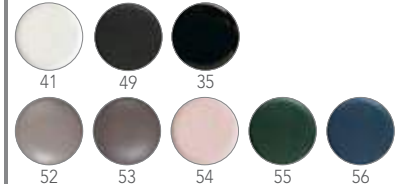

Art. 2713

L30 Cm



Porta asciugamani con mensola in ceramica 30 cm

Towel rail with ceramic shelf 30 cm

Porte-serviettes avec étagère en céramique 30 cm

Handtuchhalter mit Ablage aus Keramik 30 cm

Toallero con repisa de cerámica 30 cm

Держатель полотенец с керамической полкой 30 см

METAL ACCS / NROP / ORS +

WHITE

220,00

250,00

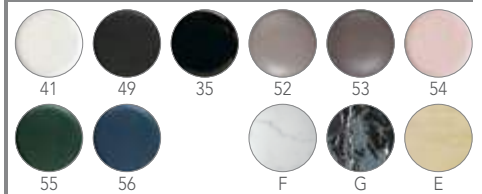

Art. 2714

L45 Cm



Porta asciugamani con mensola in ceramica 45 cm

Towel rail with ceramic shelf 45 cm

Porte-serviettes avec étagère en céramique 45 cm

Handtuchhalter mit Ablage aus Keramik 45 cm

Toallero con repisa de cerámica 45 cm

Держатель полотенец с керамической полкой 45 см

METAL ACCS / NROP / ORS +

WHITE

240,00

280,00

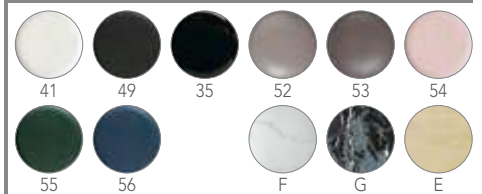

Art. 10032

COMPACT TRAP



Sifone compatto in ottone

Brass compact trap

Siphon compact en laiton

Kompakter Siphon aus Messing

Sifón compacto de latón

Компактный сифон из латуни

CR

290,00

NROP

290,00

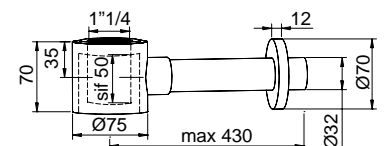

Art. 10009

Sifone tondo in ottone ribassato 1" 1/4 cromato

Cr Brass round trap, shorted 1" 1/4 chromed

Syphon petit culot laiton chromé

Siphon aus verchromtem messing, abgeflacht

Sifón redondo de latón rebajado 1" 1/4 cromado

Сифон круглого сечения 1" 1/4 укороченный, из хромированной латуни

CR

115,00

NROP

170,00

ORS

290,00



ART. 2501- 2502

Specificare colore inserti in ceramica - Indicate the ceramic inserts colour - Préciser la couleur des inserts en céramique
 Farbe der Keramikeinsätze angeben - Especificar color aplicaciones de cerámica - Уточнить цвет керамических вставок

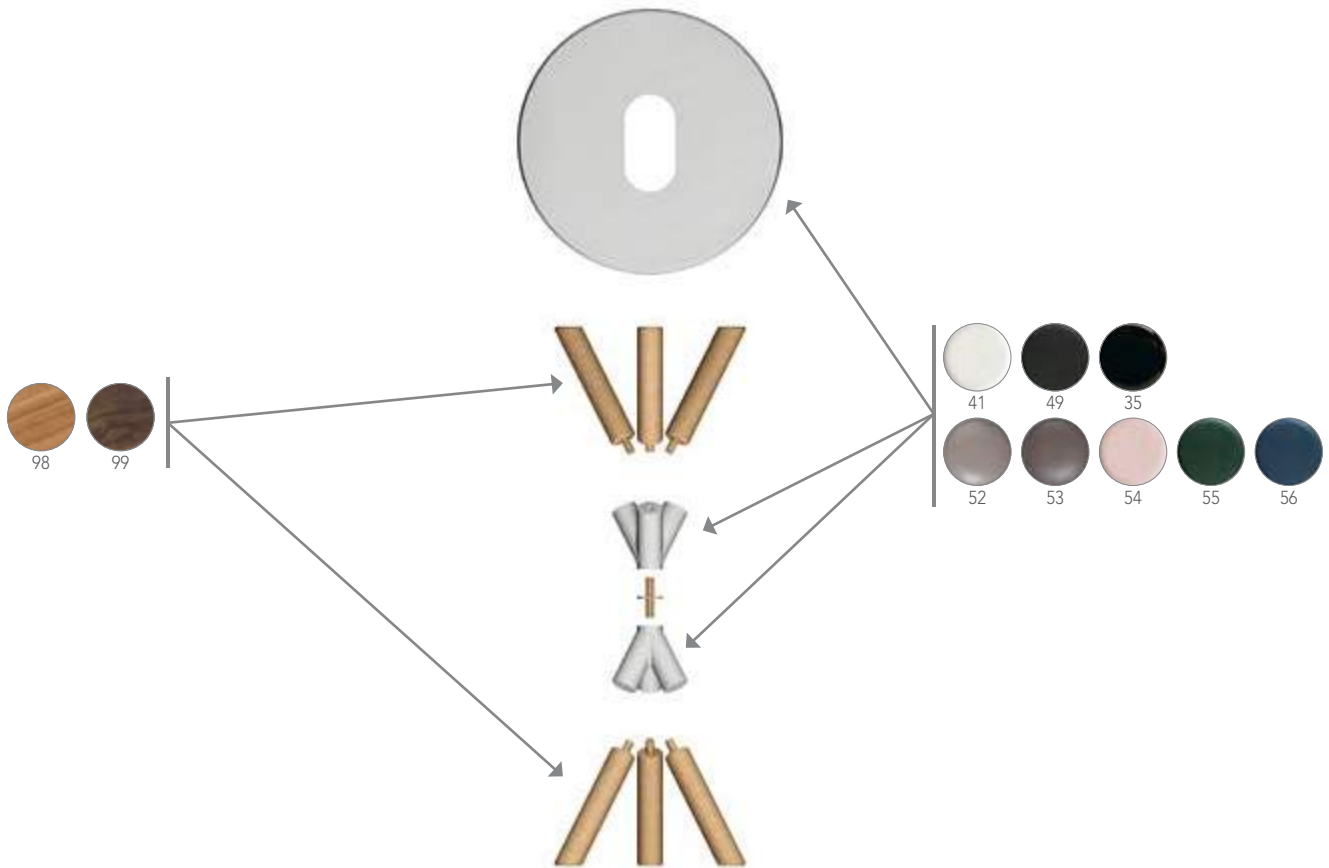

ART. 2504

Specificare colore inserti in ceramica, top e gambe in legno
 Indicate the colour of ceramic inserts, tops and wooden legs
 Préciser la couleur des inserts en céramique, du plan et des pieds en bois
 Farbe für Keramikeinsätze, Top und Holzbeine bitte angeben
 Especificar color de aplicaciones de cerámica, encimera y patas de madera
 Уточнить цвет керамических вставок, столешницы и деревянных ножек

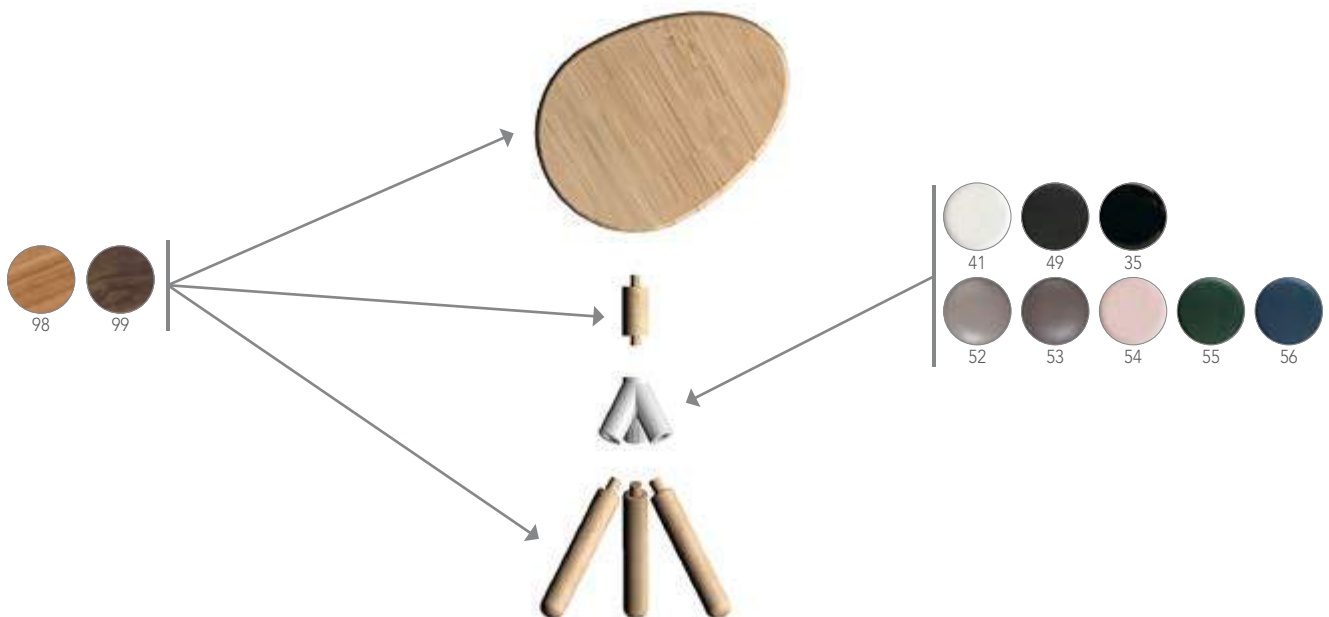

FORI PER LAVABI - HOLES FOR WASHBASINS - ORIFICIOS PARA LAVABOS - ОТВЕРСТИЯ ПОД РАКОВИНЫ УМЫВАЛЬНИКА

ART. 2501- 2502 = Ø52 mm

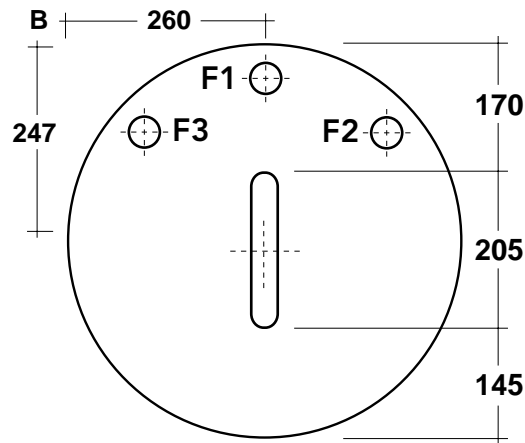

Specificare foro rubinetto: - Please specify tap hole: - Préciser le percement pour le robinet

Bohrung für Armatur angeben: - Especificar orificio grifo: - Уточнить по отверстию для крана:

F0 = no foro - no hole - sans percement - keine Bohrung - sin orificio - без отверстия

F1 = foro centrale - central hole - percement au centre - mittige Bohrung - orificio central - отверстие по центру

F2 = foro a destra - RH hole - percement à droite - Bohrung rechts - orificio a la derecha - отверстие справа

F3 = foro a sinistra - LH hole - percement à gauche - Bohrung links - orificio a la izquierda - отверстие слева

Name	Art.	B	F0	F1	F2	F3
BUCKET	8801 - 8808	■	■	■	■	■
BUCKET	8803 - 8807	■	■			
GLAM	1807 - 1808	■	■	■	■	■
GLAM	1806	■	■			
MIZU	9001 - 9005	■	■			
THIN-LINE	8029 - 8029/R	■	■			
SHAPE	8098	■	■			
LAVABI D'ARREDO	8034	■	■	■	■	■

Art. 2551

L100 P48 H20 Cm

525,00

Consolle porta lavabo 100 cm
 100 cm washbasin table
 Console porte-lavabo 100 cm
 Waschtisch 100 cm
 Consola para lavabo 100 cm
 Консоль для умывальника 100 см

Art. 2552

L80 P48 H20 Cm

470,00

Consolle porta lavabo 80 cm
 80 cm washbasin table
 Console porte-lavabo 80 cm
 Waschtisch 80 cm
 Consola para lavabo 80 cm
 Консоль для умывальника 80 см

Art. 2553

L60 P48 H20 Cm

435,00

Consolle porta lavabo 60 cm
 60 cm washbasin table
 Console porte-lavabo 60 cm
 Waschtisch 60 cm
 Consola para lavabo 60 cm
 Консоль для умывальника 60 см

Art. 2905

44 x 20 P45,5 Cm

415,00



- x1 Contenitore metallico profondità 45,5 cm
- x1 Metal container 45.5 cm depth
- x1 Caisson métallique profondeur 45,5 cm
- x1 Metallbehälter, Tiefe 45,5 cm
- x1 Contenedor metálico profundidad 45,5 cm
- x1 Металлический контейнер глубиной 45,5 см

Art. 2914

44 x 20 P43,5 Cm

415,00



- x1 Contenitore metallico profondità 43,5 cm
- x1 Metal container 43.5 cm depth
- x1 Caisson métallique profondeur 43,5 cm
- x1 Metallbehälter, Tiefe 43,5 cm
- x1 Contenedor metálico profundidad 43,5 cm
- x1 Металлический контейнер глубиной 43,5 см

Art. 2906

L99 P45,5 H20 Cm

670,00

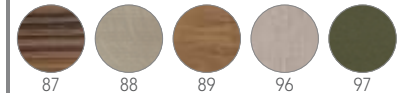

- Cassetto 99 x h20 cm
- Drawer 99 x h20 cm
- Tiroir 99 x h20 cm
- Schubfach 99 x h20 cm
- Cajón 99 x h20 cm
- Ящик 99 x B20 cm

Art. 2907

L79 P43,5 H20 Cm

625,00

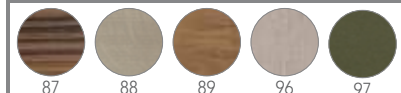

- Cassetto 79 x h20 cm
- Drawer 79 x h20 cm
- Tiroir 79 x h20 cm
- Schubfach 79 x h20 cm
- Cajón 79 x h20 cm
- Ящик 79 x B20 cm

Art. 2908

L99 P45,5 H30 Cm



Cassetto 99 x h30 cm
 Drawer 99 x h30 cm
 Tiroir 99 x h30 cm
 Schubfach 99 x h30 cm
 Cajón 99 x h30 cm
 Ящик 99 x В30 см

725,00

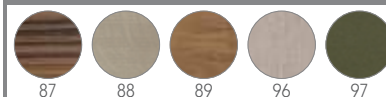

COLORS 975,00

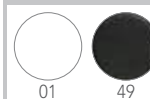

Art. 2909

L79 P43,5 H30 Cm



Cassetto 79 x h30 cm
 Drawer 79 x h30 cm
 Tiroir 79 x h30 cm
 Schubfach 79 x h30 cm
 Cajón 79 x h30 cm
 Ящик 79 x В30 см

670,00

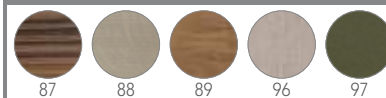

COLORS 850,00

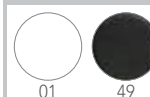

Art. 2916

L59 P43,5 H30 Cm



Cassetto 59 x h30 cm
 Drawer 59 x h30 cm
 Tiroir 59 x h30 cm
 Schubfach 59 x h30 cm
 Cajón 59 x h30 cm
 Ящик 59 x В30 см

600,00

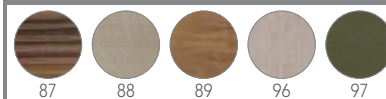

COLORS 790,00



Art. 10032

COMPACT TRAP



Sifone compatto in ottone
 Brass compact trap
 Siphon compact en laiton
 Kompakter Siphon aus Messing
 Sifón compacto de latón
 Компактный сифон из латуни

CR 290,00

NROP 290,00

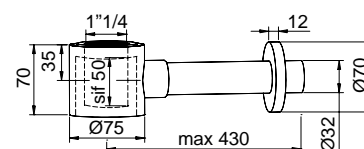

Art. 10009

Sifone tondo in ottone ribassato 1" 1/4 cromato
 Cp Brass round trap, shorted 1" 1/4 chromed
 Syphon petit culot laiton chromé
 Siphon aus verchromtem messing, abgeflacht
 Sifón redondo de latón rebajado 1" 1/4 cromado
 Сифон круглого сечения 1" 1/4 укороченный, из хромированной латуни



CR 115,00

NROP 170,00

ORS 290,00

Art. PLN1



PLANA COMPOSITION 100G _87

1.580,00

- Art. 2551 _GRG - L100 P48 H20 Cm
- Art. 2906 _87 - L99 P45,5 H20 Cm
- Art. 2207 - 100 x 40 Cm

Lavabo escluso
Washbasin excluded
Lavabo non compris
Waschbecken nicht enthalten
Lavabo excluido
Раковина умывальника не входит в комплект

MOON 42 H18 - Art. 5501_52
42 x 42 Cm - WHITE 370,00 - COLORS 570,00 - DECORLAB / DECORART 600,00

Art. PLN2



PLANA COMPOSITION 80G _88

1.415,00

- Art. 2552 _GRG - L80 P48 H20 Cm
- Art. 2907 _88 - L79 P43,5 H20 Cm
- Art. 2206 - 70 x 40 Cm

Lavabo escluso
Washbasin excluded
Lavabo non compris
Waschbecken nicht enthalten
Lavabo excluido
Раковина умывальника не входит в комплект

MOON 42 H18 - Art. 5501_52
42 x 42 Cm - WHITE 370,00 - COLORS 570,00 - DECORLAB / DECORART 600,00

Art. PLN3



PLANA COMPOSITION 100N _88

1.525,00

- Art. 2551 _NROP - L100 P48 H20 Cm
- Art. 2906 _88 - L99 P45,5 H20 Cm
- Art. 2202 - Ø70 Cm

Lavabo escluso
Washbasin excluded
Lavabo non compris
Waschbecken nicht enthalten
Lavabo excluido
Раковина умывальника не входит в комплект

GLAM 56/R - Art. 1802_56
56 x 38 Cm - WHITE 365,00 - COLORS 560,00 - DECORLAB / DECORART 610,00

Art. PLN4



PLANA COMPOSITION 100N _89

1.635,00

- Art. 2551 _NROP - L100 P48 H20 Cm
- Art. 2908 _89 - L99 P45,5 H30 Cm
- Art. 2207 - 100 x 45 Cm

Lavabo escluso
Washbasin excluded
Lavabo non compris
Waschbecken nicht enthalten
Lavabo excluido
Раковина умывальника не входит в комплект

GLAM 76 - Art. 1803_49
76 x 39 Cm - WHITE 410,00 - COLORS 625,00 - DECORART 700,00

Art. PLN5



PLANA COMPOSITION 100T

845,00

- Art. 2551 _TRT - L100 P48 H20 Cm
- Art. 2206 - 70 x 40 Cm

Lavabo escluso
Washbasin excluded
Lavabo non compris
Waschbecken nicht enthalten
Lavabo excluido
Раковина умывальника не входит в комплект

MOON 42 H18 - Art. 5501_SEM
42 x 42 Cm - WHITE 370,00 - COLORS 570,00 - DECORLAB / DECORART 600,00

Art. PLN6

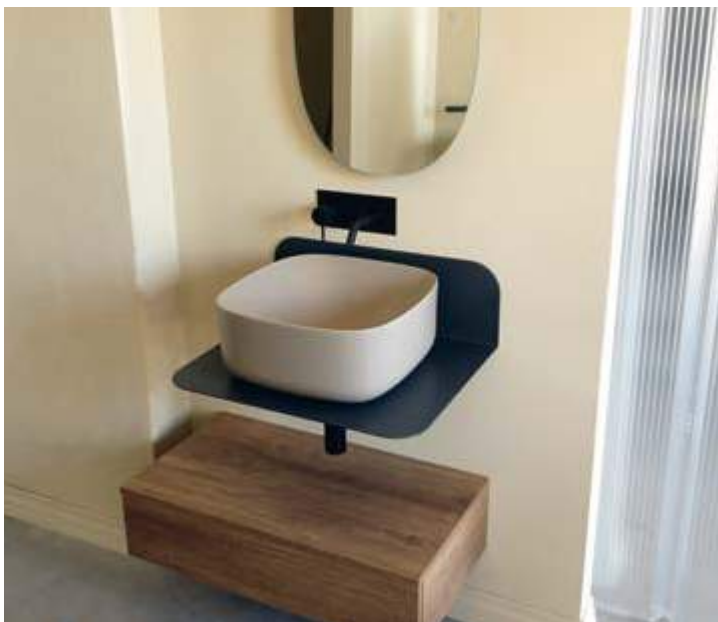

PLANA COMPOSITION 60N _89

1.380,00

- Art. 2553 _NROP - L60 P48 H20 Cm
- Art. 2907 _89 - L79 P43,5 H20 Cm
- Art. 2206 - 70 x 40 Cm

Lavabo escluso
Washbasin excluded
Lavabo non compris
Waschbecken nicht enthalten
Lavabo excluido
Раковина умывальника не входит в комплект

MOON 42 H18 - Art. 5501_52
42 x 42 Cm - WHITE 370,00 - COLORS 570,00 - DECORLAB / DECORART 600,00

FORI PER LAVABI - HOLES FOR WASHBASINS - ORIFICIOS PARA LAVABOS - ОТВЕРСТИЯ ПОД РАКОВИНЫ УМЫВАЛЬНИКА

ART. 2551 = 1000 X 480 mm

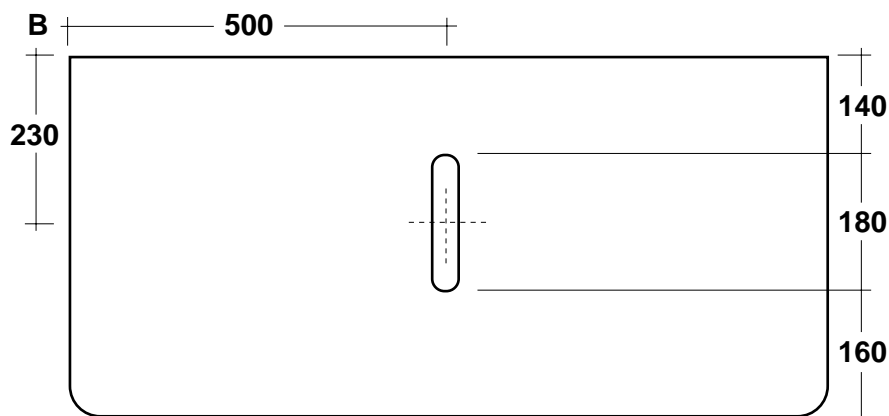

Name	Art.	B				
MOON	5501 - 5502 - 5504 - 5505 - 5506	■				
BUCKET	8807 - 8808 - 8810	■				
BUTTERFLY	4001 - 4002	■				
PLANET	8111 - 8112	■				
NEXT	8306 - 8307	■				
TEOREMA 2.0	5101 - 5102	■				
GLAM	1802 - 1803 - 1804 - 1806 - 1807	■				
MIZU	9001 - 9003 - 9005 - 9007	■				
THIN-LINE	8010 - 8029 - 8030 - 8045 - 8046	■				
KONG	8052 - 8053	■				

Per i lavabi senza foro rubinetto va utilizzato il rubinetto a muro
 The wall tap must be used for the washbasins without hole
 Pour les lavabos sans percement pour robinet, un robinet mural est utilisé
 Die Waschbecken ohne Abbildung des Wasserhahns werden mit Wandarmatur installiert
 Para los lavabos sin orificio para grifo se debe utilizar el grifo de pared
 Для умывальников без отверстия для крана используется настенный кран

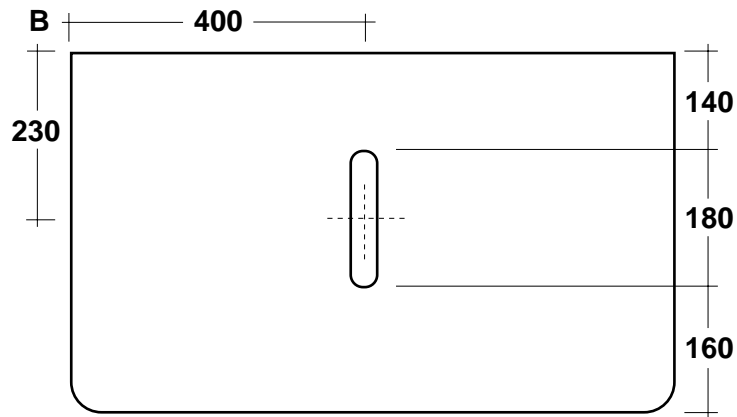

Name	Art.	B				
MOON	5501 - 5502 - 5504 - 5505	■				
BUCKET	8807 - 8808 - 8810 - 8811	■				
BUTTERFLY	4001 - 4002	■				
PLANET	8111 - 8112	■				
NEXT	8306 - 8307	■				
TEOREMA 2.0	5101	■				
GLAM	1802 - 1803 - 1804 - 1806 - 1807 - 1808	■				
MIZU	9001 - 9003 - 9005 - 9007	■				
THIN-LINE	8010 - 8029 - 8030 - 8045 - 8046	■				
KONG	8052 - 8053	■				

Per i lavabi senza foro rubinetto va utilizzato il rubinetto a muro
 The wall tap must be used for the washbasins without hole
 Pour les lavabos sans percement pour robinet, un robinet mural est utilisé
 Die Waschbecken ohne Abbildung des Wasserhahns werden mit Wandarmatur installiert
 Para los lavabos sin orificio para grifo se debe utilizar el grifo de pared
 Для умывальников без отверстия для крана используется настенный кран

Art. 2301

L53,5 H60 Cm

310,00

Specchio tondo con mensola

Round mirror with shelf

Miroir rond avec étagère

Runder Spiegel mit Ablage

Espejo redondo con repisa

Зеркало круглое с полкой

Art. 2302

L51 H82 Cm

345,00

Specchio in tubolare tondo con mensola e porta bicchiere

Tubular round mirror with shelf and glass holder

Miroir avec tube rond, étagère et porte-gobelet

Spiegel mit Rahmen aus rundem Rohr, Ablage und Becherhalter

Espejo tubular redondo con repisa y soporte para vaso

Зеркало круглое из трубчатого профиля с полкой и подстаканником

Art. 2304

H37 P8 L25 Cm

185,00

Specchio contenitore a muro apertura laterale

Mirror with wall container and lateral opening

Miroir avec caisson mural ouverture latérale

Spiegelschrank mit seitlicher Öffnung

Espejo contenedor de pared apertura lateral

Настенный зеркальный шкафчик, открывающийся сбоку

Art. 2303

L25 P20 H25 Cm

135,00



Cubo asimmetrico
Asymmetric cube
Cube asymétrique
Asymmetrischer Würfel
Cubo asimétrico
Асимметричный куб



Art. 2305

L12 P24 H24 Cm

120,00



Pensile contenitore a muro apertura laterale
Wall unit with wall container and lateral opening
Élément suspendu avec caisson mural ouverture latérale
Hängeschrank mit seitlicher Öffnung
Mueble alto contenedor de pared apertura lateral
Навесной настенный шкаф, открывающийся сбоку



Art. 2306

L23,5 P24 H24 Cm

125,00



Pensile contenitore a muro apertura laterale grande
Wall unit with wall container and lateral opening, large size
Élément suspendu avec caisson mural grande ouverture latérale
Hängeschrank mit großer seitlicher Öffnung
Mueble alto contenedor de pared apertura lateral grande
Большой навесной настенный шкаф, открывающийся сбоку



Art. 10032

COMPACT TRAP



Sifone compatto in ottone
Brass compact trap
Siphon compact en laiton
Kompakter Siphon aus Messing
Sifón compacto de latón
Компактный сифон из латуни

CR 290,00
NROP 290,00

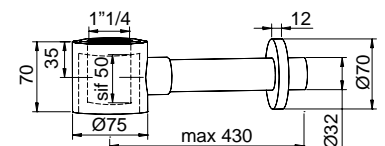

Art. 10009



Sifone tondo in ottone ribassato 1" 1/4 cromato
Cp Brass round trap, shorted 1" 1/4 chromed
Syphon petit culot laiton chromé
Siphon aus verchromtem messing, abgeflacht
Sifón redondo de latón rebajado 1" 1/4 cromado
Сифон круглого сечения 1"1/4 укороченный, из хромированной латуни

CR 115,00
NROP 170,00
ORS 290,00

Art. FO1

FOLD COMPOSITION 53T
555,00

- Art. 2301 _TRT - L53,5 H60 Cm
- Art. 2305 _TRT - L12 P24 H24 Cm
- Art. 2306 _TRT - L23,5 P24 H24 Cm

Lavabo escluso
 Washbasin excluded
 Lavabo non compris
 Waschbecken nicht enthalten
 Lavabo excludido
 Раковина умывальника не входит в комплект

CUBE 24 H24 - Art. 1521_49
 24 x 24 Cm - WHITE 275,00 - COLORS 485,00 - DECORLAB 510,00

Art. FO2

FOLD COMPOSITION 37N
430,00

- Art. 2304 _NROP - L37 P8 H25 Cm
- Art. 2305 _NROP - L12 P24 H24 Cm
- Art. 2306 _NROP - L23,5 P24 H24 Cm

Lavabo escluso
 Washbasin excluded
 Lavabo non compris
 Waschbecken nicht enthalten
 Lavabo excludido
 Раковина умывальника не входит в комплект

CUBE 42 H24 - Art. 1522_SFLNR
 42 x 24 Cm - WHITE 320,00 - COLORS 535,00 - DECORLAB 580,00

Art. FO3

FOLD COMPOSITION 37NB
305,00

- Art. 2304 _NROP - L37 P8 H25 Cm
- Art. 2305 _NROP - L12 P24 H24 Cm

Lavabo escluso
 Washbasin excluded
 Lavabo non compris
 Waschbecken nicht enthalten
 Lavabo excludido
 Раковина умывальника не входит в комплект

CUBE 24 H24 - Art. 1521_SENR
 24 x 24 Cm - WHITE 275,00 - COLORS 485,00 - DECORLAB 510,00

Art. FO4

FOLD COMPOSITION 51N



480,00

- Art. 2302 _NROP - L51 H82 Cm

- Art. 2303 _NROP - L25 P20 H25 Cm

Lavabo escluso
Washbasin excluded
Lavabo non compris
Waschbecken nicht enthalten
Lavabo excluido
Раковина умывальника не входит в комплект

SOFT 45 - Art. 1501_SEM

45 x 22 Cm - WHITE 280,00 - COLORS 470,00 - DECORLAB 495,00

Art. FO4

FOLD COMPOSITION 100G



770,00

- Art. 2205 - 100 x 60 Cm

- Art. 2305 _GRG - L12 P24 H24 Cm

- Art. 2306 _GRG - L23,5 P24 H24 Cm - x2

Lavabo escluso
Washbasin excluded
Lavabo non compris
Waschbecken nicht enthalten
Lavabo excluido
Раковина умывальника не входит в комплект

CUBE 24 H24 - Art. 1521_49

24 x 24 Cm - WHITE 275,00 - COLORS 485,00 - DECORLAB 510,00

CUBE 42 H24 - Art. 1522_49

42 x 24 Cm - WHITE 320,00 - COLORS 535,00 - DECORLAB 580,00

Art. FO6

FOLD COMPOSITION 50N



385,00

- Art. 2201 - Ø50 Cm

- Art. 2303 _NROP - L52 P20 H25 Cm

Lavabo escluso
Washbasin excluded
Lavabo non compris
Waschbecken nicht enthalten
Lavabo excluido
Раковина умывальника не входит в комплект

SOFT 45 - Art. 1501

45 x 22 Cm - WHITE 280,00 - COLORS 470,00 - DECORLAB 495,00

Art. 2701

L44 P39 H63,5 Cm

395,00

Consolle per lavabo Moon Art. 5503 (42x42x40H)
 Console for Moon washbasin Art. 5503 (42x42x40H)
 Console pour lavabo Moon Art. 5503 (42x42x40H)
 Konsole für Waschbecken Moon, Artikel 5503 (42x42x40H)
 Consola para lavabo Moon Art. 5503 (42x42x40H)
 Консоль для умывальника Moon арт. 5503 (42x42x40H)

Art. 2702

L44 P39 H77,5 Cm

395,00

Consolle per lavabo Moon Art. 5501 (42)-5504 (42R)
 Console for Moon washbasin Art. 5501 (42)-5504 (42R)
 Console pour lavabo Moon Art. 5501 (42)-5504 (42R)
 Konsole für Waschbecken Moon, Artikel 5501 (42)-5504 (42R)
 Consola para lavabo Moon Art. 5501 (42)-5504 (42R)
 Консоль для умывальника Moon арт. 5501 (42)-5504 (42R)

Art. 2703

L74,5 P39 H77,5 Cm

415,00

Consolle per lavabo Moon 5502 (70)-5005 (70R)
 Console for Moon washbasin Art. 5502 (70)-5005 (70R)
 Console pour lavabo Moon Art. 5502 (70)-5005 (70R)
 Konsole für Waschbecken Moon, Artikel 5502 (70)-5005 (70R)
 Consola para lavabo Moon Art. 5502 (70)-5005 (70R)
 Консоль для умывальника Moon арт. 5502 (70)-5005 (70R)

Art. 2704

L45 H90 Cm

615,00



Specchio con porta asciugamano, mensola, applique integrata

Mirror with towel rail, shelf, and built-in wall lamp

Miroir avec porte-serviette, tablette, applique intégrée

Spiegel mit Handtuchhalter, Ablage und integrierter Leuchte

Espejo con toallero, repisa, aplique integrado

Зеркало с держателем для полотенца, полкой и встроенным светильником бра

Art. 2705

L39,5 P35 H20 Cm

470,00

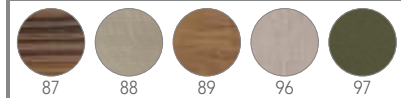

Cassetto H20 per Art. 2701/2702

Drawer H20 for Art. 2701/2702

Tiroir H20 pour Art. 2701/2702

Schubfach Höhe 20 für Artikel 2701/2702

Cajón H20 para Art. 2701/2702

Ящик В20 для арт. 2701/2702

Art. 2706

L70 P35 H20 Cm

580,00

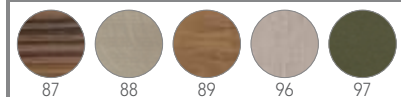

Cassetto H20 per Art. 2703

Drawer H20 for Art. 2703

Tiroir H20 pour Art. 2703

Schubfach Höhe 20 für Artikel Art. 2703

Cajón H20 para Art. 2703

Ящик В20 для арт. 2703

Art. 2711

L39,5 P35 H30 Cm

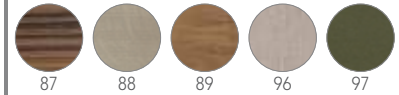
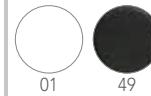
515,00

COLORS
635,00

Cassetto H30 per Art. 2701/2702

Drawer H30 for 2701/2702

Tiroir H30 pour Art. 2701/2702

Schubfach Höhe 30 für Artikel 2701/2702

Cajón H30 para Art. 2701/2702

Ящик В30 для арт. 2701/2702

Art. 2712

L70 P35 H30 Cm

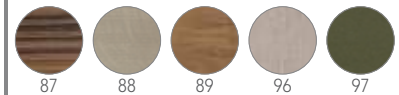
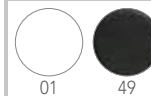
635,00

COLORS
800,00

Cassetto H30 per Art. 2703

Drawer H30 for Art. 2703

Tiroir H30 pour Art. 2703

Schubfach Höhe 30 für Artikel 2703

Cajón H30 para Art. Art. 2703

Ящик В30 для арт. 2703

Art. 2707

L32,5 P26,5 H2 Cm

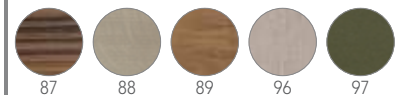
110,00

Ripiano in legno per Art. 2701/2702

Wooden shelf for Art. 2701/2702

Plateau en bois pour Art. 2701/2702

Top aus Holz für Artikel 2701/2702

Estante de madera para Art. 2701/2702

Деревянная полка для арт. 2701/2702

Art. 2708

L61 P26,5 H2 Cm



140,00

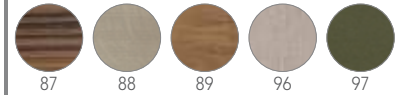

Ripiano in legno per Art. 2703

Wooden shelf for Art. 2703

Plateau en bois pour Art. 2703

Top aus Holz für Artikel 2703

Estante de madera para Art. 2703

Деревянная полка для арт. 2703

Art. 2709

L42 P42 H1,5 Cm



WHITE 235,00

COLORS 300,00

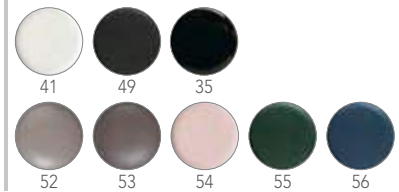

Ripiano in ceramica per Art. 2701/2702

Ceramic shelf for Art. 2701/2702

Plateau en céramique pour Art. 2701/2702

Top aus Keramik für Artikel 2701/2702

Estante de cerámica para Art. 2701/2702

Керамическая полка для арт. 2701/2702

DecorART 350,00

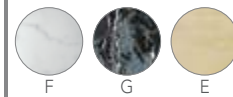

Art. 2710

L72 P42 H1,5 Cm



WHITE 350,00

COLORS 420,00

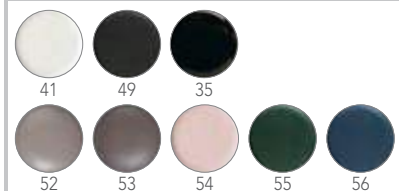

Ripiano in ceramica per Art. 2703

Ceramic shelf for Art. 2703

Plateau en céramique pour Art. 2703

Top aus Keramik für Artikel 2703

Estante de cerámica para Art. 2703

Керамическая полка для арт. 2703

DecorART 450,00



Art. 2715

L72 P42 H1,5 Cm

Senza foro rubinetto - Without tap hole - Sans percement pour robinet - Ohne Bohrung für Armatur - Sin orificio grifo - Без отверстия для крана

Art. 2716

L72 P42 H1,5 Cm

Foro rubinetto DX - RH tap hole - Percement pour robinet DTE - Bohrung für Armatur rechts - Orificio grifo dch. - Отверстие для крана ПР

Art. 2717

L72 P42 H1,5 Cm

Foro rubinetto SX - LH tap hole - Percement pour robinet GCH - Bohrung für Armatur links - Orificio grifo izq. - Отверстие для крана ЛВ



Ripiano in ceramica per Art. 2703 con predisposizione per lavabi GLAM Art. 1808 / 1807

Ceramic shelf for Art. 2703 ready for installation in GLAM washbasins Art. 1808 / 1807

Plateau en céramique pour Art. 2703 avec préparation pour lavabos GLAM Art. 1808 / 1807

Top aus Keramik für Artikel 2703, vorbereitet für die Installation von Waschbecken GLAM, Artikel 1808 / 1807

Estante de cerámica para Art. 2703 con predisposición para lavabos GLAM Art. 1808 / 1807

Керамическая столешница для арт. 2703, готовая для установки умывальников GLAM арт. 1808 / 1807

WHITE

350,00

COLORS

420,00

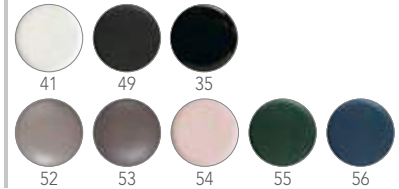

DecorART

450,00

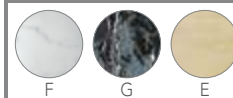

Art. 2713



Porta asciugamani con mensola in ceramica 30 cm

Towel rail with ceramic shelf 30 cm

Porte-serviettes avec étagère en céramique 30 cm

Handtuchhalter mit Ablage aus Keramik 30 cm

Toallero con repisa de cerámica 30 cm

Держатель полотенец с керамической полкой 30 см

L30 Cm

METAL ACCS / NROP / ORS +

WHITE

220,00

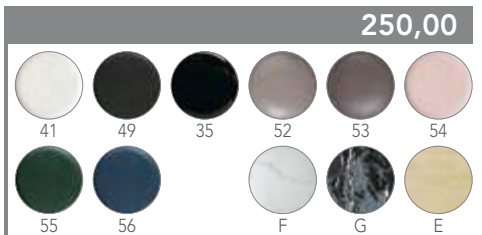

Art. 2714

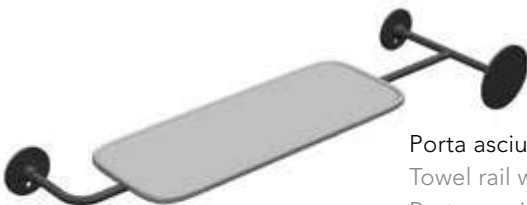

Porta asciugamani con mensola in ceramica 45 cm

Towel rail with ceramic shelf 45 cm

Porte-serviettes avec étagère en céramique 45 cm

Handtuchhalter mit Ablage aus Keramik 45 cm

Toallero con repisa de cerámica 45 cm

Держатель полотенец с керамической полкой 45 см

L45 Cm

METAL ACCS / NROP / ORS +

WHITE

240,00

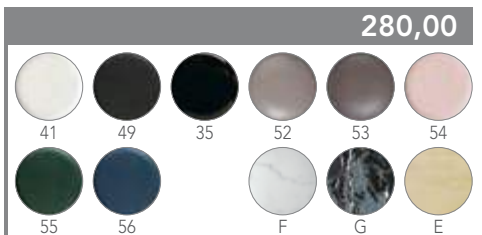

Art. 10032

COMPACT TRAP



Sifone compatto in ottone

Brass compact trap

Siphon compact en laiton

Kompakter Siphon aus Messing

Sifón compacto de latón

Компактный сифон из латуни

CR

/ NROP

290,00

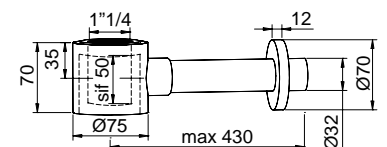

Art. 10009

COMPACT TRAP

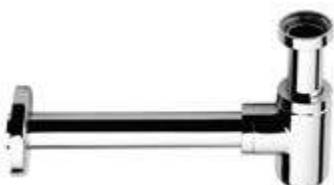

Sifone tondo in ottone ribassato 1"1/4 cromato

Cr Brass round trap, shorted 1" 1/4 chromed

Syphon petit culot laiton chromé

Siphon aus verchromtem messing, abgeflacht

Sifón redondo de latón rebajado 1" 1/4 cromado

Сифон круглого сечения 1"1/4 укороченный, из хромированной латуни

CR

/ NROP

11500

NROP

/ ORS

170,00

ORS

/

290,00

Art. DIV1



DIVA COMPOSITION 44N _87

1.755,00

- Art. 2702 _NROP - L44 P39 H77,5 Cm
- Art. 2705 _87 - L39,5 P35 H20 Cm
- Art. 2206 - 70 x 40 Cm
- Art. 5501 _41 - Moon 42 H18 - 42 x 42 Cm

Art. DIV2



DIVA COMPOSITION 44N _97

1.865,00

- Art. 2702 _NROP - L44 P39 H77,5 Cm
- Art. 2711 _97 - L39,5 P35 H30 Cm
- Art. 2207 - 100 x 45 Cm
- Art. 5504 _41 - Moon 42R H18 - 42 x 42 Cm

Art. DIV3



DIVA COMPOSITION 43N _87

1.815,00

- Art. 2701 _NROP - L44 P39 H63,5 Cm
- Art. 2707 _87 - L32,5 P26,5 H2 Cm
- Art. 2704 _NROP - L45 H90 Cm
- Art. 5503 _41 - Moon 42 H40 - 42 x 42 Cm

Art. DIV4



DIVA COMPOSITION 43N _89

1.880,00

- Art. 2701 _NROP - L44 P39 H63,5 Cm
- Art. 2705 _89 - L39,5 P35 H20 Cm
- Art. 2206 - 70 x 40 Cm
- Art. 5503 _56 - Moon 42 H40 - 42 x 42 Cm

Art. DIV5



DIVA COMPOSITION 73G _41

1.860,00

- Art. 2703 _GRG - L74,5 P39 H77,5 Cm
- Art. 2710 _41 - L72 P42 H1,5 Cm
- Art. 2202 - Ø70 Cm
- Art. 5502 _41 - Moon 71 H18 - 72 x 42 Cm

Art. DIV6



DIVA COMPOSITION 73T _96

2.065,00

- Art. 2703 _TRT - L74,5 P39 H77,5 Cm
- Art. 2712 _96 - L70 P35 H30 Cm
- Art. 2206 - 70 x 40 Cm
- Art. 5505 _52 - Moon 70R H18 - 72 x 42 Cm

Art. DIV7

DIVA COMPOSITION 73T _96

2.215,00



- Art. 2703 _GRG - L74,5 P39 H77,5 Cm
- Art. 2716 _41 - L72 P42 H1,5 Cm
- Art. 2706 _88 - L70 P35 H20 Cm
- Art. 2207 - 100 x 45 Cm
- Art. 1807 _49 - Glam Ø39 - Ø39 Cm

Art. DIV21

DIVA COMPOSITION 730 _01

2.520,00



- Art. 2703 _ORS - L74,5 P39 H77,5 Cm
- Art. 2712 _01 - L70 P35 H30 Cm
- Art. 2714 _ORS _41 - L45 Cm
- Art. 2202 - Ø70 Cm
- Art. 5505 _41 - Moon 70R H18 - 72 x 42 Cm

Art. DIV22

DIVA COMPOSITION 43N _01

2.100,00



- Art. 2702 _NROP - L44 P39 H77,5 Cm
- Art. 2711 _01 - L39,5 P35 H30 Cm
- Art. 2713 _NROP _49 - L30 Cm
- Art. 2201 - Ø50 Cm
- Art. 5504 _41 - Moon 42R H18 - 42 x 42 Cm

Art. DIV23



DIVA COMPOSITION 43N _49

2.100,00

- Art. 2702 _NROP - L44 P39 H77,5 Cm
- Art. 2711 _49 - L39,5 P35 H30 Cm
- Art. 2713 _NROP _49 - L30 Cm
- Art. 2201 - Ø50 Cm
- Art. 5504 _41 - Moon 42R H18 - 42 x 42 Cm

Art. DIV24



DIVA COMPOSITION 73N _55

2.685,00

- Art. 2703 _NROP - L74,5 P39 H77,5 Cm
- Art. 2716 _55 - L72 P42 H1,5 Cm
- Art. 2712 _49 - L70 P35 H30 Cm
- Art. 2713 _NROP _49 - L30 Cm
- Art. 2207 - 100 x 45 Cm
- Art. 1807 _55 - Glam Ø39 - Ø39 Cm

Art. DIV24b



DIVA COMPOSITION 73N _52

2.685,00

- Art. 2703 _NROP - L74,5 P39 H77,5 Cm
- Art. 2716 _52 - L72 P42 H1,5 Cm
- Art. 2712 _49 - L70 P35 H30 Cm
- Art. 2713 _NROP _49 - L30 Cm
- Art. 2207 - 100 x 45 Cm
- Art. 1807 _52 - Glam Ø39 - Ø39 Cm

Art. DIV25

DIVA COMPOSITION 730 _56

2.280,00



- Art. 2703 _ORS - L74,5 P39 H77,5 Cm
- Art. 2716 _56 - L72 P42 H1,5 Cm
- Art. 2710 _56 - L72 P42 H1,5 Cm
- Art. 2714 _ORS _56 - L45 Cm
- Art. 2202 - Ø70 Cm
- Art. 1807 _ 56 - Glam Ø39 - Ø39 Cm

Art. DIV26

DIVA COMPOSITION 73N _56

2.305,00



- Art. 2703 _NROP - L74,5 P39 H77,5 Cm
- Art. 2716 _56 - L72 P42 H1,5 Cm
- Art. 2710 _56 - L72 P42 H1,5 Cm
- Art. 2713 _NROP _56 - L30 Cm
- Art. 2207 - 100 x 45 Cm
- Art. 1807 _ 56 - Glam Ø39 - Ø39 Cm

Art. DIV26b

DIVA COMPOSITION 73N _54

1.920,00



- Art. 2703 _NROP - L74,5 P39 H77,5 Cm
- Art. 2716 _54 - L72 P42 H1,5 Cm
- Art. 2710 _54 - L72 P42 H1,5 Cm
- Art. 2201 - Ø50 Cm
- Art. 1807 _ 54 - Glam Ø39 - Ø39 Cm

Art. DIV27



DIVA COMPOSITION 730 _F

1.895,00

- Art. 2703 _ORS - L74,5 P39 H77,5 Cm
- Art. 2710 _F - L72 P42 H1,5 Cm
- Art. 2202 - Ø70 Cm
- Art. 5505 _F - Moon 70R H18 - 72 x 42 Cm

Art. DIV28



DIVA COMPOSITION 43N _E

1.595,00

- Art. 2702 _NROP - L44 P39 H77,5 Cm
- Art. 2709 _E - L42 P42 H1,5 Cm
- Art. 2201 - Ø50 Cm
- Art. 5504 _E - Moon 42R H18 - 42 x 42 Cm

Art. DIV29



DIVA COMPOSITION 73N _E

1.895,00

- Art. 2703 _NROP - L74,5 P39 H77,5 Cm
- Art. 2710 _E - L72 P42 H1,5 Cm
- Art. 2202 - Ø70 Cm
- Art. 5505 _E - Moon 70R H18 - 72 x 42 Cm

Art. DIV30



DIVA COMPOSITION 43N _G

1.695,00

- Art. 2701 _NROP - L44 P39 H63,5 Cm
- Art. 2709 _G - L42 P42 H1,5 Cm
- Art. 2201 - Ø50 Cm
- Art. 5503 _G - Moon 42 H40 - 42 x 42 Cm

Art. DIV31



DIVA COMPOSITION 430 _G

1.875,00

- Art. 2702 _ORS - L44 P39 H77,5 Cm
- Art. 2709 _G - L42 P42 H1,5 Cm
- Art. 2714 _ORS _49 - L45 Cm
- Art. 2201 - Ø50 Cm
- Art. 5501 _G - Moon 42 H18 - 42 x 42 Cm

Art. DIV31b



DIVA COMPOSITION 430 _Gb

2.160,00

- Art. 2702 _ORS - L44 P39 H77,5 Cm
- Art. 2711 _49 - L39,5 P35 H30 Cm
- Art. 2714 _ORS _49 - L45 Cm
- Art. 2201 - Ø50 Cm
- Art. 5501 _G - Moon 42 H18 - 42 x 42 Cm

Art. DIV32



Art. DIV32b



Art. DIV33



DIVA COMPOSITION 43N _F

1.975,00

- Art. 2701 _NROP - L44 P39 H63,5 Cm
- Art. 2709 _F - L42 P42 H1,5 Cm
- Art. 2714 _NROP _49 - L45 Cm
- Art. 2201 - Ø50 Cm
- Art. 5503 _F - Moon 42 H40 - 42 x 42 Cm

DIVA COMPOSITION 43N _Fb

2.260,00

- Art. 2701 _NROP - L44 P39 H63,5 Cm
- Art. 2711 _49 - L39,5 P35 H30 Cm
- Art. 2714 _NROP _49 - L45 Cm
- Art. 2201 - Ø50 Cm
- Art. 5503 _F - Moon 42 H40 - 42 x 42 Cm

DIVA COMPOSITION 73N _EE

2.295,00

- Art. 2703 _NROP - L74,5 P39 H77,5 Cm
- Art. 2716 _E - L72 P42 H1,5 Cm
- Art. 2710 _E - L72 P42 H1,5 Cm
- Art. 2714 _NROP _49 - L45 Cm
- Art. 2201 - Ø50 Cm
- Art. 1807 _E - Glam Ø39 - Ø39 Cm

Art. DIV34

DIVA COMPOSITION 73N _F

2.295,00



- Art. 2703 _NROP - L74,5 P39 H77,5 Cm
- Art. 2716 _F - L72 P42 H1,5 Cm
- Art. 2710 _F - L72 P42 H1,5 Cm
- Art. 2714 _NROP _49 - L45 Cm
- Art. 2201 - Ø50 Cm
- Art. 1807 _F - Glam Ø39 - Ø39 Cm



Art. 5503



Art. 5501



Art. 5504



Art. 5502



Art. 5505

WASHBASIN MOON



Art. 1808



Art. 1807

WASHBASIN GLAM

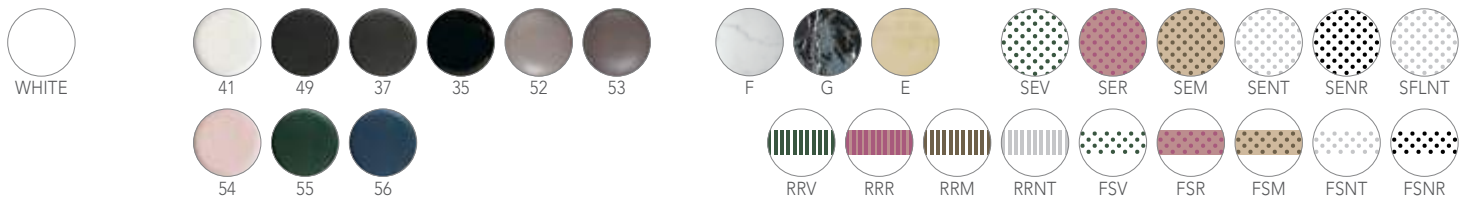

Art. 2701



Art. 2702



Art. 2703



Art. 2704

CONSOLE / EQUIPPED MIRROR



Art. 2707



Art. 2708



Art. 2705



Art. 2706



Art. 2711



Art. 2712

WOODEN DRAWER / SHELF

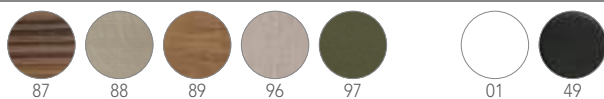

Art. 2709



Art. 2710



Art. 2715 / 2716 / 2717

CERAMIC SHELF





Art. 5503
Art. 2701
Art. 2705



Art. 5503
Art. 2701
Art. 2711



Art. 5503
Art. 2701
Art. 2707



Art. 5503
Art. 2701
Art. 2709



Art. 5501 / 5504
Art. 2702
Art. 2705



Art. 5501 / 5504
Art. 2702
Art. 2711



Art. 5501 / 5504
Art. 2702
Art. 2707



Art. 5501 / 5504
Art. 2702
Art. 2709



Art. 5502 / 5505
Art. 2703
Art. 2706



Art. 5502 / 5505
Art. 2703
Art. 2712



Art. 5502 / 5505
Art. 2703
Art. 2708



Art. 5502 / 5505
Art. 2703
Art. 2710



Art. 1808 / 1807
Art. 2715 / 2716 / 2717
Art. 2703 - Art. 2706



Art. 1808 / 1807
Art. 2715 / 2716 / 2717
Art. 2703 - Art. 2712



Art. 1808 / 1807
Art. 2715 / 2716 / 2717
Art. 2703 - Art. 2708



Art. 1808 / 1807
Art. 2715 / 2716 / 2717
Art. 2703 - Art. 2710

Art. 6016

L59 P44 H75 Cm



720,00

STRUCTURE



WOOD

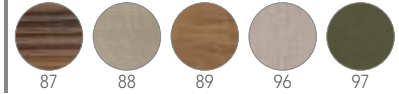

Consolle 59 cm con top in legno
 59 cm table with wooden top
 Console 59 cm avec plan en bois
 Waschtisch 59 cm mit Top aus Holz
 Consola 59 cm con encimera de madera
 Консоль 59 см с деревянной столешницей

Art. 6018

L79 P44 H75 Cm



780,00

STRUCTURE



WOOD

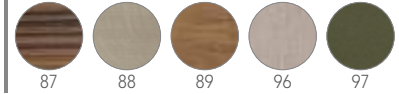

Consolle 79 cm con top in legno
 79 cm table with wooden top
 Console 79 cm avec plan en bois
 Waschtisch 79 cm mit Top aus Holz
 Consola 79 cm con encimera de madera
 Консоль 79 см с деревянной столешницей

- Se non viene specificato il lavabo il top viene inviato senza foro - Se si desidera un foro per un lavabo non in lista il costo extra netto è di Euro 50 - I soli lavabi abbinabili sono quelli nel catalogo Scarabeo 2020, salvo diverse disposizioni
 - If the washbasin is not indicated, the top is shipped without hole - The additional net cost for a hole in a washbasin that is not in the list is Euro 50 - Only the washbasins contained in the Scarabeo 2020 catalogue can be matched, except where otherwise stated
 - Si le type de lavabo n'est pas précisé, le plan est envoyé sans perçement - Si vous souhaitez un perçement pour un lavabo hors catalogue, 50 euros seront facturés en supplément - Les seuls lavabos combinables sont repris dans le catalogue Scarabeo 2020, sauf mention contraire
 - Bei fehlender Angabe des Modells wird das Waschbecken ohne Bohrung geliefert - Für Bohrungen an Waschbecken, die nicht in der Liste enthalten sind, wird ein Zuschlag von 50 Euro berechnet - Nur die Waschbecken aus dem Katalog Scarabeo 2020 sind kombinierbar, sofern nicht anders angegeben
 - Si no está especificado el lavabo, la encimera se envía sin orificio - Si se desea un orificio para un lavabo que no figura en la lista, el coste extra neto es de 50 euros - Los únicos lavabos instalables son aquellos del catálogo Scarabeo 2020, salvo en caso de disposiciones diferentes
 - Если умывальник не будет указан, столешница будет отправлена без отверстия - Если необходимо выполнить отверстие для умывальника, который не входит в перечень, наценка-нетто составит 50 евро - Сочетаются только умывальники из каталога Scarabeo 2020, за исключением других типов размещения

Art. 2713



Porta asciugamani con mensola in ceramica 30 cm
Towel rail with ceramic shelf 30 cm
Porte-serviettes avec étagère en céramique 30 cm
Handtuchhalter mit Ablage aus Keramik 30 cm
Toallero con repisa de cerámica 30 cm
Держатель полотенец с керамической полкой 30 см

L30 Cm

METAL ACCS / NROP / ORS +

WHITE 220,00

250,00

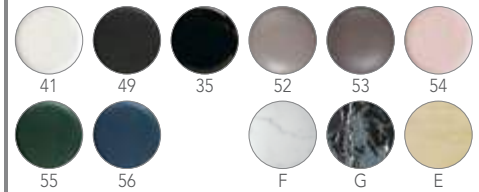

Art. 2714

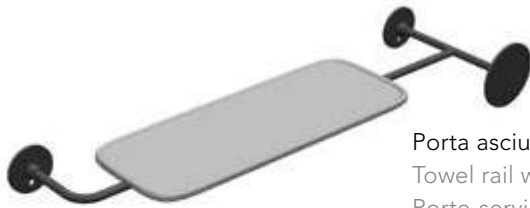

Porta asciugamani con mensola in ceramica 45 cm
Towel rail with ceramic shelf 45 cm
Porte-serviettes avec étagère en céramique 45 cm
Handtuchhalter mit Ablage aus Keramik 45 cm
Toallero con repisa de cerámica 45 cm
Держатель полотенец с керамической полкой 45 см

L45 Cm

METAL ACCS / NROP / ORS +

WHITE 240,00

280,00

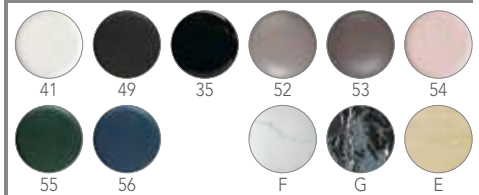

Art. 10032

COMPACT TRAP



Sifone compatto in ottone
Brass compact trap
Siphon compact en laiton
Kompakter Siphon aus Messing
Sifón compacto de latón
Компактный сифон из латуни

CR 290,00

NROP 290,00

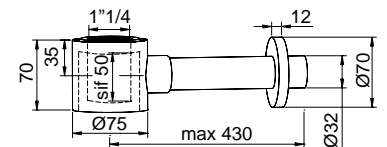

Art. 10009



Sifone tondo in ottone ribassato 1"1/4 cromato
Cp Brass round trap, shorted 1" 1/4 chromed
Syphon petit culot laiton chromé
Siphon aus verchromtem messing, abgeflacht
Sifón redondo de latón rebajado 1" 1/4 cromado
Сифон круглого сечения 1"1/4 укороченный, из хромированной латуни

CR 115,00

NROP 170,00

ORS 290,00

Art. FU1



FUJI COMPOSITION 59 _49 _89

1.300,00

- Art. 6016 _49 _89 - L59 P44 H75 Cm

- Art. 2202 - Ø70 Cm

- Art. 2713 _NROP _49 - L30 Cm

Lavabo escluso
Washbasin excluded
Lavabo non compris
Waschbecken nicht enthalten
Lavabo excluido
Раковина умывальника не входит в комплект

GLAM Ø39 - Art. 1807_53

Ø39 Cm - WHITE 230,00 - COLORS 415,00 - DECORLAB / DECORART 450,00

Art. FU2



FUJI COMPOSITION 59 _BS _88

970,00

Art. 6016 _BS _88 - L59 P44 H75 Cm

Art. 2201 - Ø50 Cm

Lavabo escluso
Washbasin excluded
Lavabo non compris
Waschbecken nicht enthalten
Lavabo excluido
Раковина умывальника не входит в комплект

GLAM Ø39 - Art. 1807_41

Ø39 Cm - WHITE 230,00 - COLORS 415,00 - DECORLAB / DECORART 450,00

Art. FU3



FUJI COMPOSITION 79 _49 _89

1.110,00

- Art. 6018 _49 _89 - L79 P44 H75 Cm

- Art. 2202 - Ø70 Cm

Lavabo escluso
Washbasin excluded
Lavabo non compris
Waschbecken nicht enthalten
Lavabo excluido
Раковина умывальника не входит в комплект

GLAM Ø39 - Art. 1807_41

Ø39 Cm - WHITE 230,00 - COLORS 415,00 - DECORLAB / DECORART 450,00

Art. FU4

FUJI COMPOSITION 79 _49 _88

1.390,00



- Art. 6018 _49 _88 - L79 P44 H75 Cm

- Art. 2202 - Ø70 Cm

- Art. 2714 _NROP _52 - L45 Cm

Lavabo escluso
 Washbasin excluded
 Lavabo non compris
 Waschbecken nicht enthalten
 Lavabo excluido
 Раковина умывальника не входит в комплект

GLAM 56 - Art. 1804 _52

56 x 39 Cm - WHITE 365,00 - COLORS 560,00 - DECORLAB / DECORART 610,00

Art. 1830

L120 P50 H35 Cm



Struttura porta lavabo in tubolare 120 cm con mensola
 120 cm tubular washbasin frame with shelves
 Structure porte-lavabo tubulaire 120 cm avec étagères
 Waschbeckenuntergestell aus rohr 120 cm mit ablagen
 Estructura para lavabo tubular 120 cm con repisas
 Навесной держатель раковины умывальника из трубчатого профиля 120 см, с полкой

950,00

STRUCTURE



WOOD

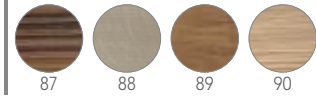

1.260,00

STRUCTURE



WOOD

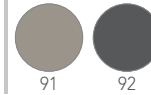

Art. 1831

L120 P50 H35 Cm



Struttura porta lavabo in tubolare 120 cm con cassetto
 120 cm tubular washbasin frame with drawer
 Structure porte-lavabo tubulaire 120 cm avec tiroir
 Waschbeckenuntergestell aus rohr 120 cm mit schubfach
 Estructura para lavabo tubular 120 cm con cajones
 Навесной держатель раковины умывальника из трубчатого профиля 120 см, с ящиком

1.655,00

STRUCTURE



WOOD

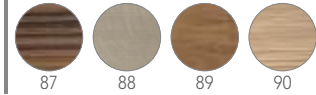

2.050,00

STRUCTURE

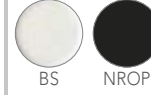

WOOD

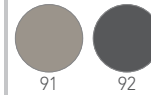

Art. 1832

L120 P50 H35 Cm



Struttura porta lavabo in tubolare 120 cm con doppia anta
 120 cm tubular washbasin frame with double door
 Structure porte-lavabo tubulaire 120 cm avec double porte
 Waschbeckenuntergestell aus rohr 120 cm mit zwei türen
 Estructura para lavabo tubular 120 cm con doble puerta
 Навесной держатель раковины умывальника из трубчатого профиля 120 см, с двустворчатой дверцей

1.480,00

STRUCTURE



WOOD

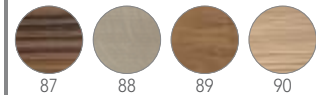

1.930,00

STRUCTURE

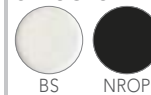

WOOD

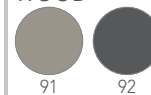

- Se non viene specificato il lavabo il top viene inviato senza foro - Se si desidera un foro per un lavabo non in lista il costo extra netto è di Euro 50 - I soli lavabi abbinabili sono quelli nel catalogo Scarabeo 2020, salvo diverse disposizioni
 - If the washbasin is not indicated, the top is shipped without hole - The additional net cost for a hole in a washbasin that is not in the list is Euro 50 - Only the washbasins contained in the Scarabeo 2020 catalogue can be matched, except where otherwise stated
 - Si le type de lavabo n'est pas précisé, le plan est envoyé sans percement - Si vous souhaitez un percement pour un lavabo hors catalogue, 50 euros seront facturés en supplément - Les seuls lavabos combinables sont repris dans le catalogue Scarabeo 2020, sauf mention contraire
 - Bei fehlender Angabe des Modells wird das Waschbecken ohne Bohrung geliefert - Für Bohrungen an Waschbecken, die nicht in der Liste enthalten sind, wird ein Zuschlag von 50 Euro berechnet - Nur die Waschbecken aus dem Katalog Scarabeo 2020 sind kombinierbar, sofern nicht anders angegeben
 - Si no está especificado el lavabo, la encimera se envía sin orificio - Si se desea un orificio para un lavabo que no figura en la lista, el coste extra neto es de 50 euros - Los únicos lavabos instalables son aquellos del catálogo Scarabeo 2020, salvo en caso de disposiciones diferentes
 - Если умывальник не будет указан, столешница будет отправлена без отверстия - Если необходимо выполнить отверстие для умывальника, который не входит в перечень, наценка-нетто составит 50 евро - Сочетаются только умывальники из каталога Scarabeo 2020, за исключением других типов размещения

Art. 1833

L90 P50 H35 Cm



Struttura porta lavabo in tubolare 90 cm con mensola

90 cm tubular washbasin frame with shelves

Structure porte-lavabo tubulaire 90 cm avec étagères

Waschbeckenuntergestell aus rohr 90 cm mit ablagen

Estructura para lavabo tubular 90 cm con repisas

Навесной держатель раковины умывальника из трубчатого профиля 90 см, с полкой

910,00

STRUCTURE



WOOD

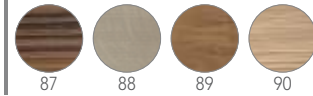

1.030,00

STRUCTURE



WOOD

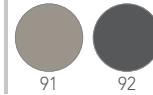

Art. 1834

L90 P50 H35 Cm



Struttura porta lavabo in tubolare 90 cm con cassetto

90 cm tubular washbasin frame with drawer

Structure porte-lavabo tubulaire 90 cm avec tiroir

Waschbeckenuntergestell aus rohr 90 cm mit schubfach

Estructura para lavabo tubular 90 cm con cajones

Навесной держатель раковины умывальника из трубчатого профиля 90 см, с ящиком

1.510,00

STRUCTURE



WOOD

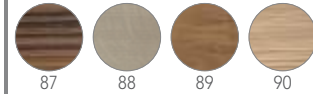

1.865,00

STRUCTURE

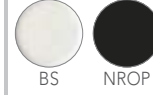

WOOD

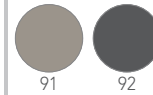

Art. 1835

L90 P50 H35 Cm



Struttura porta lavabo in tubolare 90 cm con doppia anta

90 cm tubular washbasin frame with double door

Structure porte-lavabo tubulaire 90 cm avec double porte

Waschbeckenuntergestell aus rohr 90 cm mit zwei türen

Estructura para lavabo tubular 90 cm con doble puerta

Навесной держатель раковины умывальника из трубчатого профиля 90 см, с двустворчатой дверцей

1.260,00

STRUCTURE



WOOD

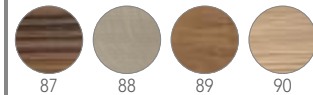

1.735,00

STRUCTURE

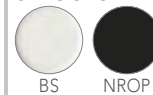

WOOD

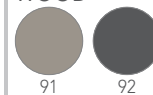

- Se non viene specificato il lavabo il top viene inviato senza foro - Se si desidera un foro per un lavabo non in lista il costo extra netto è di Euro 50 - I soli lavabi abbinabili sono quelli nel catalogo Scarabeo 2020, salvo diverse disposizioni
 - If the washbasin is not indicated, the top is shipped without hole - The additional net cost for a hole in a washbasin that is not in the list is Euro 50 - Only the washbasins contained in the Scarabeo 2020 catalogue can be matched, except where otherwise stated
 - Si le type de lavabo n'est pas précisé, le plan est envoyé sans percement - Si vous souhaitez un percement pour un lavabo hors catalogue, 50 euros seront facturés en supplément - Les seuls lavabos combinables sont repris dans le catalogue Scarabeo 2020, sauf mention contraire
 - Bei fehlender Angabe des Modells wird das Waschbecken ohne Bohrung geliefert - Für Bohrungen an Waschbecken, die nicht in der Liste enthalten sind, wird ein Zuschlag von 50 Euro berechnet - Nur die Waschbecken aus dem Katalog Scarabeo 2020 sind kombinierbar, sofern nicht anders angegeben
 - Si no está especificado el lavabo, la encimera se envía sin orificio - Si se desea un orificio para un lavabo que no figura en la lista, el coste extra neto es de 50 euros - Los únicos lavabos instalables son aquellos del catálogo Scarabeo 2020, salvo en caso de disposiciones diferentes
 - Если умывальник не будет указан, столешница будет отправлена без отверстия - Если необходимо выполнить отверстие для умывальника, который не входит в перечень, наценка-нетто составит 50 евро - Сочетаются только умывальники из каталога Scarabeo 2020, за исключением других типов размещения

Art. 1836

L60 P50 H35 Cm



Struttura porta lavabo in tubolare 60 cm con mensola
 60 cm tubular washbasin frame with shelves
 Structure porte-lavabo tubulaire 60 cm avec étagères
 Waschbeckenuntergestell aus rohr 60 cm mit ablagen
 Estructura para lavabo tubular 60 cm con repisas
 Навесной держатель раковины умывальника из трубчатого профиля 90 см, с полкой

685,00

STRUCTURE



WOOD

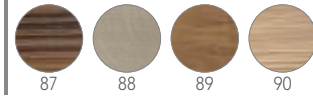

835,00

STRUCTURE



WOOD

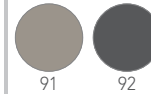

Art. 1837

L60 P50 H35 Cm



Struttura porta lavabo in tubolare 60 cm con cassetto
 60 cm tubular washbasin frame with drawer
 Structure porte-lavabo tubulaire 60 cm avec tiroir
 Waschbeckenuntergestell aus rohr 60 cm mit schubfach
 Estructura para lavabo tubular 60 cm con cajones
 Навесной держатель раковины умывальника из трубчатого профиля 60 см, с ящиком

1.385,00

STRUCTURE



WOOD

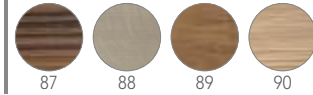

1.535,00

STRUCTURE

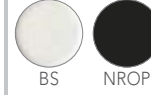

WOOD

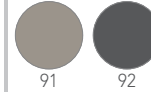

Art. 1838

L60 P50 H35 Cm



Struttura porta lavabo in tubolare 60 cm con anta singola
 60 cm tubular washbasin frame with single door
 Structure porte-lavabo tubulaire 60 cm avec porte simple
 Waschbeckenuntergestell aus rohr 60 cm mit einer tür
 Estructura para lavabo tubular 60 cm con puerta simple
 Навесной держатель раковины умывальника из трубчатого профиля 60 см, с одностворчатой дверцей

1.070,00

STRUCTURE



WOOD

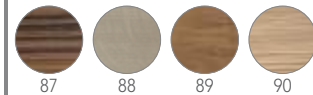

1.330,00

STRUCTURE



WOOD

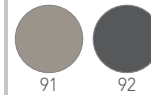

- Se non viene specificato il lavabo il top viene inviato senza foro - Se si desidera un foro per un lavabo non in lista il costo extra netto è di Euro 50 - I soli lavabi abbinabili sono quelli nel catalogo Scarabeo 2020, salvo diverse disposizioni
 - If the washbasin is not indicated, the top is shipped without hole - The additional net cost for a hole in a washbasin that is not in the list is Euro 50 - Only the washbasins contained in the Scarabeo 2020 catalogue can be matched, except where otherwise stated
 - Si le type de lavabo n'est pas précisé, le plan est envoyé sans percement - Si vous souhaitez un percement pour un lavabo hors catalogue, 50 euros seront facturés en supplément - Les seuls lavabos combinables sont repris dans le catalogue Scarabeo 2020, sauf mention contraire
 - Bei fehlender Angabe des Modells wird das Waschbecken ohne Bohrung geliefert - Für Bohrungen an Waschbecken, die nicht in der Liste enthalten sind, wird ein Zuschlag von 50 Euro berechnet - Nur die Waschbecken aus dem Katalog Scarabeo 2020 sind kombinierbar, sofern nicht anders angegeben
 - Si no está especificado el lavabo, la encimera se envía sin orificio - Si se desea un orificio para un lavabo que no figura en la lista, el coste extra neto es de 50 euros - Los únicos lavabos instalables son aquellos del catálogo Scarabeo 2020, salvo en caso de disposiciones diferentes
 - Если умывальник не будет указан, столешница будет отправлена без отверстия - Если необходимо выполнить отверстие для умывальника, который не входит в перечень, наценка-нетто составит 50 евро - Сочетаются только умывальники из каталога Scarabeo 2020, за исключением других типов размещения

Art. 1839

L35 P20 H90 Cm



Pensile in tubolare con porta asciugamani integrato
 Tubular wall unit with built-in towel rail
 Élément haut tubulaire avec porte-serviettes intégré
 Hängeschrank aus rohr mit integriertem handtuchhalter
 Mueble alto tubular con toallero integrado
 Навесной шкаф из трубчатого профиля со встроенным держателем полотенец

920,00

STRUCTURE



WOOD

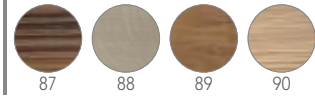

1.165,00

STRUCTURE



WOOD

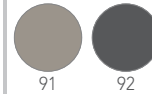

Art. 1840

L35 P20 H24 cm



Mensola con porta asciugamani integrato
 Shelf with built-in towel rail
 Étagère avec porte-serviettes intégré
 Ablage mit integriertem handtuchhalter
 Repisa con toallero integrado
 Полка со встроенным держателем полотенец

525,00

STRUCTURE



WOOD

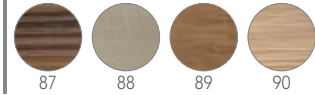

560,00

STRUCTURE

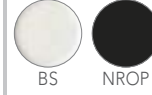

WOOD

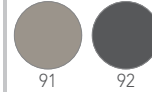

Art. 10032

COMPACT TRAP



Sifone compatto in ottone
 Brass compact trap
 Siphon compact en laiton
 Kompakter Siphon aus Messing
 Sifón compacto de latón
 Компактный сифон из латуни

CR 290,00

NROP 290,00

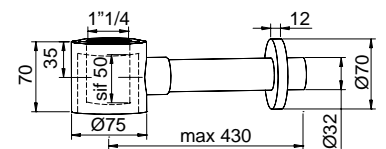

Art. 10009

Sifone tondo in ottone ribassato 1" 1/4 cromato
 Cp Brass round trap, shorted 1" 1/4 chromed
 Syphon petit culot laiton chromé
 Siphon aus verchromtem messing, abgeflacht
 Sifón redondo de latón rebajado 1" 1/4 cromado
 Сифон круглого сечения 1"1/4 укороченный, из хромированной латуни

CR 115,00

NROP 170,00

ORS 290,00



Art. 10029
SPACE SAVING SINK SIPHON

Sifone per lavabo salvaspazio
 Space saving sink siphon
 Siphon pour lavabo dimension reduite
 Platzsparender Spülensiphon
 Sifón de fregadero que ahorra espacio
 Сифон для экономии пространства

 -- **40,00**
Art. 1841
ROUND MIRROR - Ø50 Cm

Specchio tondo
 Round mirror
 Miroir rond
 Runder spiegel
 Espejo redondo
 Зеркало круглое

 -- **220,00**
Art. 1842
RECTANGULAR MIRROR - 80 x 70 Cm

Specchio rettangolare
 Rectangular mirror
 Miroir rectangulaire
 Rechteckiger spiegel
 Espejo rectangular
 Зеркало прямоугольное

 -- **280,00**
Art. 1843
ROUND MIRROR - Ø75 Cm

Specchio tondo
 Round mirror
 Miroir rond
 Runder spiegel
 Espejo redondo
 Зеркало круглое

 -- **280,00**

Art. FRM1



FRAME COMPOSITION 60_1837

2.525,00

- Art. 1837 _NROP _88 - L60 P50 H35 cm
- Art. 1839 _NROP _88 - L35 P20 H90 cm
- Art. 1841 - Ø50 cm

Lavabo escluso
Washbasin excluded
Lavabo non compris
Waschbecken nicht enthalten
Lavabo excludido
Раковина умывальника не входит в комплект

OVO Art. 8011
41 x 33,5 cm - WHITE 205,00 - COLORS 420,00

Art. FRM2



FRAME COMPOSITION 90_1833

2.575,00

- Art. 1833 _NROP _87 - L90 P50 H35 cm
- Art. 1839 _NROP _87 - L35 P20 H90 cm
- Art. 1840 _NROP _87 - L35 P20 H24 cm
- Art. 1841 - Ø50 cm

Lavabo escluso
Washbasin excluded
Lavabo non compris
Waschbecken nicht enthalten
Lavabo excludido
Раковина умывальника не входит в комплект

GLAM Ø33 Art. 1808
Ø33 cm - WHITE 195,00 - COLORS 385,00 - DECORLAB / DECORART 415,00

Art. FRM3



FRAME COMPOSITION 90_1833b

1.190,00

- Art. 1833 _NROP _89 - L90 P50 H35 cm
- Art. 1842 - 80 x 70 cm

Lavabo escluso
Washbasin excluded
Lavabo non compris
Waschbecken nicht enthalten
Lavabo excludido
Раковина умывальника не входит в комплект

GLAM 56/AR Art. 1810
56 x 39 cm - WHITE 380,00 - COLORS 590,00 - DECORART 620,00

Art. FRM4



FRAME COMPOSITION 90_1835

2.985,00

- Art. 1835 _NROP _87 - L90 P50 H35 cm
- Art. 1839 _NROP _87 - L35 P20 H90 cm
- Art. 1840 _NROP _87 - L35 P20 H24 cm
- Art. 1842 - 80 x 70 cm

Lavabo escluso
Washbasin excluded
Lavabo non compris
Waschbecken nicht enthalten
Lavabo excluido
Раковина умывальника не входит в комплект

GLAM 56/R Art. 1802
56 x 37 cm - WHITE 365,00 - COLORS 560,00 - DECORART 610,00

Art. FRM5



FRAME COMPOSITION 120_1830

1.915,00

- Art. 1830 _BS _90 - L120 P50 H35 cm
- Art. 1840 BS _90 - L35 P20 H24 cm
- Art. 1841 x2 - Ø50 cm

Lavabo escluso
Washbasin excluded
Lavabo non compris
Waschbecken nicht enthalten
Lavabo excluido
Раковина умывальника не входит в комплект

GLAM Ø39 Art. 1807
Ø39 cm - WHITE 230,00 - COLORS 415,00 - DECORLAB / DECORART 450,00

Art. FRM6



FRAME COMPOSITION 120_1831

4.055,00

- Art. 1831 _BS _91 - L120 P50 H35 cm
- Art. 1839 _BS _91 - L35 P20 H90 cm
- Art. 1840 _BS _91 - L35 P20 H24 cm
- Art. 1842 - 80 x 70 cm

Lavabo escluso
Washbasin excluded
Lavabo non compris
Waschbecken nicht enthalten
Lavabo excluido
Раковина умывальника не входит в комплект

GLAM 76 Art. 1803
76 x 39 cm - WHITE 410,00 - COLORS 625,00 - DECORART 700,00

Art. FRM7

FRAME COMPOSITION 120_1834



3.235,00

- Art. 1834 _NROP _87 - L90 P50 H35 cm
- Art. 1839 _NROP _87 - L35 P20 H90 cm
- Art. 1840 _NROP _87 - L35 P20 H24 cm
- Art. 1842 - 80 x 70 cm

Lavabo escluso
 Washbasin excluded
 Lavabo non compris
 Waschbecken nicht enthalten
 Lavabo excluido
 Раковина умывальника не входит в комплект

MOON 42R H18 Art. 5504_49
 42 x 42 cm - WHITE 390,00 - COLORS 570,00 - DECORLAB / DECORART 600,00

Art. FRM8

FRAME COMPOSITION 90_1834b



1.790,00

- Art. 1834 _NROP _89 - L90 P50 H35 cm
- Art. 1842 - 80 x 70 cm

Lavabo escluso
 Washbasin excluded
 Lavabo non compris
 Waschbecken nicht enthalten
 Lavabo excluido
 Раковина умывальника не входит в комплект

MOON 42R H18 Art. 5504_52
 42 x 42 cm - WHITE 390,00 - COLORS 570,00 - DECORLAB / DECORART 600,00

FORI PER LAVABI - HOLES FOR WASHBASINS - ORIFICIOS PARA LAVABOS - ОТВЕРСТИЯ ПОД РАКОВИНЫ УМЫВАЛЬНИКА

ART. 1830 / 1831 / 1832 = 1200 X 500 mm

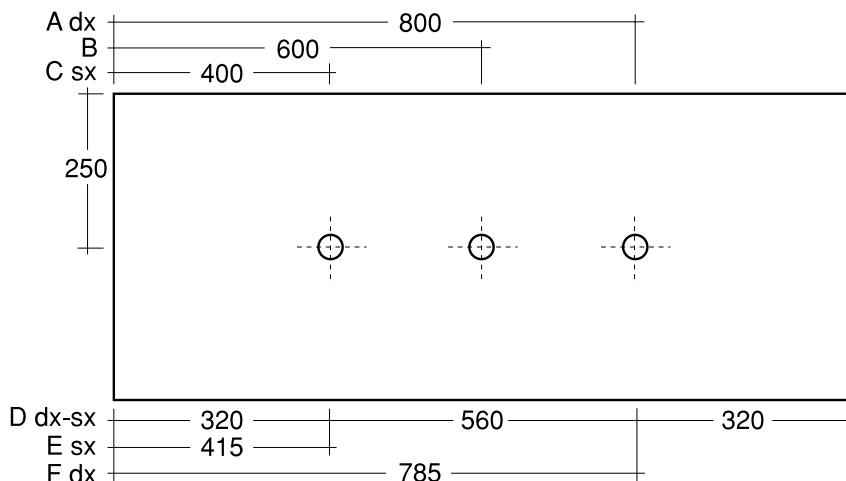

Name	Art.	A dx	B	C sx	D dx-sx
MOON	5501 - 5502 - 5503 - 5504 - 5505 - 5507 - 5508 - 5511 - 5512		■	■	■
MOON	5506 - 5509		■		
BUCKET	8807 - 8808 - 8809 - 8810 - 8811	■	■	■	■
BUTTERFLY	4001 - 4003	■	■	■	■
BUTTERFLY	4002 - 4004 - 4005	■	■	■	
PLANET	8109 - 8111	■	■	■	
PLANET	8110 - 8112	■	■	■	■
MOAI	8601 - 8602 - 8610	■	■	■	
NEXT	8047/A - 8047/B - 8306 - 8307 - 8308	■	■	■	■
TEOREMA 2.0	5101 - 5104 - 5105 - 5110 - 5111 - 5112 - 5114 - 5115 - 5117 - 5118 - 5123	■	■	■	■
TEOREMA 2.0	5108 - 5109		■	■	■
TEOREMA 2.0	5102 - 5106/R-100/A-B - 5119 - 5120 - 5124		■		
TEOREMA	8031 - 8031/R - 8031/R-40 - 8031/R-60 - 8031-40 - 5001 - 5002	■	■	■	■
TEOREMA	8031-60 - 8031/R-80 - 5003	■	■	■	
TEOREMA	8031-80 - 8031/R-100/A-B		■		
GLAM	1806 - 1807 - 1808	■	■	■	■
GLAM	1802 - 1801 - 1803 - 1804 - 1805 - 1810 - 1812	■	■	■	
GLAM	1803		■		
MIZU	9002 - 9004 - 9005 - 9006	■	■	■	■
MIZU	9001 - 9003 - 9007 - 9008	■	■	■	
FUJI	6001 - 6003 - 6013	■	■	■	■
FUJI	6002 - 6004 - 6014 - 6015	■	■	■	
ZEFIRO	8201 - 8204 - 8205 - 8206 - 8207	■	■	■	
THIN-LINE	8046 - 8046/R - 8045	■	■	■	
THIN-LINE	8044 - 8009 - 8009/R - 8010 - 8010/R	■	■	■	■
THIN-LINE	8011 - 8029 - 8029/R - 8030 - 8030/R	■	■	■	■
KONG	8051 - 8051/R	■	■	■	■
KONG	8052 - 8052/R	■	■	■	
KONG	8053 - 8053/R - 8054 - 8054/R		■		
TSUNAMI	8038 - 8038/R		■		
TSUNAMI	8039 - 8039/R	■	■	■	
SHAPE	8098	■	■	■	■
SQUARE	8025/A - 8025/B	■	■	■	
SQUARE	8025/A - 8025/B	■	■	■	■
LAVABI D'ARREDO	8003 - 8034	■	■	■	■

- Se non viene specificato il lavabo il top viene inviato senza foro - Se si desidera un foro per un lavabo non in lista il costo extra netto è di Euro 50 - I soli lavabi abbinabili sono quelli nel catalogo Scarabeo 2020, salvo diverse disposizioni
 - If the washbasin is not indicated, the top is shipped without hole - The additional net cost for a hole in a washbasin that is not in the list is Euro 50 - Only the washbasins contained in the Scarabeo 2020 catalogue can be matched, except where otherwise stated
 - Si le type de lavabo n'est pas précisé, le plan est envoyé sans perçement - Si vous souhaitez un perçement pour un lavabo hors catalogue, 50 euros seront facturés en supplément - Les seuls lavabos combinables sont repris dans le catalogue Scarabeo 2020, sauf mention contraire
 - Bei fehlender Angabe des Modells wird das Waschbecken ohne Bohrung geliefert - Für Bohrungen an Waschbecken, die nicht in der Liste enthalten sind, wird ein Zuschlag von 50 Euro berechnet - Nur die Waschbecken aus dem Katalog Scarabeo 2020 sind kombinierbar, sofern nicht anders angegeben
 - Si no está especificado el lavabo, la encimera se envía sin orificio - Si se desea un orificio para un lavabo que no figura en la lista, el coste extra neto es de 50 euros - Los únicos lavabos instalables son aquellos del catálogo Scarabeo 2020, salvo en caso de disposiciones diferentes
 - Если умывальник не будет указан, столешница будет отправлена без отверстия - Если необходимо выполнить отверстие для умывальника, который не входит в перечень, наценка-нетто составит 50 евро - Сочетаются только умывальники из каталога Scarabeo 2020, за исключением других типов размещения

FORI PER LAVABI - HOLES FOR WASHBASINS - ORIFICIOS PARA LAVABOS - ОТВЕРСТИЯ ПОД РАКОВИНЫ УМЫВАЛЬНИКА

ART. 1833 / 1834 / 1835 = 900 X 500 mm

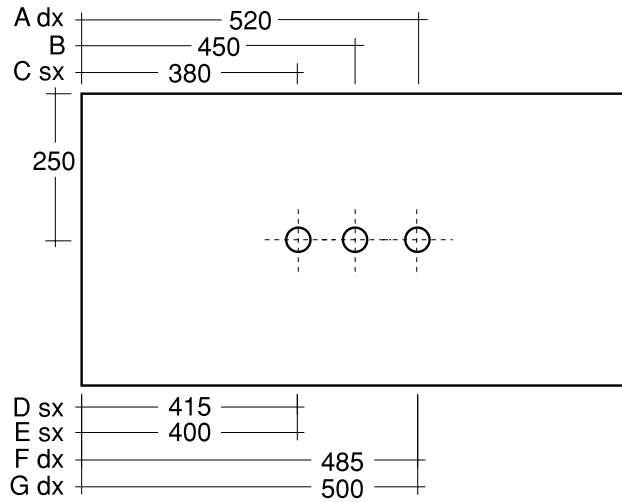

Name	Art.	A dx	B	C sx	D sx	E sx	F dx	G dx
MOON	5501 - 5503 - 5504 - 5507 - 5511	■	■	■				
MOON	5502 - 5505 - 5506 - 5508 - 5509 - 5512		■					
BUCKET	8807 - 8808 - 8809 - 8810 - 8811	■	■	■				
BUTTERFLY	4001 - 4002 - 4003 - 4004	■	■	■				
PLANET	8109 - 8110 - 8111 - 8112	■	■	■				
MOAI	8601 - 8602 - 8610	■	■	■				
NEXT	8047/A - 8047/B - 8306 - 8307 - 8308	■	■	■				
TEOREMA 2.0	5101 - 5108 - 5109 - 5104 - 5105 - 5111 - 5112 - 5114 - 5117	■	■	■				
TEOREMA 2.0	5102 - 5110 - 5115 - 5118 - 5123		■					
TEOREMA	8031 - 8031/R - 8031/R-60 - 8031-40 - 8031-60 - 5001 - 5002	■	■	■				
TEOREMA	8031/R80 - 8031-80 - 5003		■					
GLAM	1802 - 1804 - 1805 - 1810 - 1811	■	■	■				
GLAM	1806 - 1807 - 1808	■	■	■				
GLAM	1801 - 1803 - 1812		■		■		■	
MIZU	9001 - 9002 - 9003 - 9004 - 9005 - 9006 - 9007 - 9008	■	■	■				
FUJI	6001 - 6002 - 6003 - 6004 - 6013 - 6014 - 6015	■	■	■				
ZEFIRO	8201 - 8204 - 8205 - 8206 - 8207	■	■	■				
THIN-LINE	8046 - 8046/R - 8045 - 8044 - 8009 - 8009/R	■	■	■				
THIN-LINE	8010 - 8010/R - 8011 - 8029 - 8029/R - 8030 - 8030/R	■	■	■				
KONG	8051 - 8051/R - 8052 - 8052/R	■	■	■				
KONG	8053 - 8053/R		■					
TSUNAMI	8039 - 8039/R	■	■	■				
SHAPE	8098	■	■	■				
SQUARE	8025/A		■			■		■
SQUARE	8025/B	■	■	■				
LAVABI D'ARREDO	8003 - 8034	■	■	■				

- Se non viene specificato il lavabo il top viene inviato senza foro - Se si desidera un foro per un lavabo non in lista il costo extra netto è di Euro 50 - I soli lavabi abbinabili sono quelli nel catalogo Scarabeo 2020, salvo diverse disposizioni
 - If the washbasin is not indicated, the top is shipped without hole - The additional net cost for a hole in a washbasin that is not in the list is Euro 50 - Only the washbasins contained in the Scarabeo 2020 catalogue can be matched, except where otherwise stated
 - Si le type de lavabo n'est pas précisé, le plan est envoyé sans perçement - Si vous souhaitez un perçement pour un lavabo hors catalogue, 50 euros seront facturés en supplément - Les seuls lavabos combinables sont repris dans le catalogue Scarabeo 2020, sauf mention contraire
 - Bei fehlender Angabe des Modells wird das Waschbecken ohne Bohrung geliefert - Für Bohrungen an Waschbecken, die nicht in der Liste enthalten sind, wird ein Zuschlag von 50 Euro berechnet - Nur die Waschbecken aus dem Katalog Scarabeo 2020 sind kombinierbar, sofern nicht anders angegeben
 - Si no está especificado el lavabo, la encimera se envía sin orificio - Si se desea un orificio para un lavabo que no figura en la lista, el coste extra neto es de 50 euros - Los únicos lavabos instalables son aquellos del catálogo Scarabeo 2020, salvo en caso de disposiciones diferentes
 - Если умывальник не будет указан, столешница будет отправлена без отверстия - Если необходимо выполнить отверстие для умывальника, который не входит в перечень, наценка-нетто составит 50 евро - Сочетаются только умывальники из каталога Scarabeo 2020, за исключением других типов размещения

FRAME 2.0

Art. 1844

L60 P50 H75 Cm



930,00

STRUCTURE



NROP

WOOD



87

88

89

96

97

Struttura porta lavabo in alluminio 60 cm con gambe e porta asciugamani DX
60 cm aluminium washbasin frame with legs and RH towel rail
Structure porte-lavabo en aluminium 60 cm avec pied et porte-serviette DTE
Waschbeckenuntergestell aus Aluminium, 60 cm, mit Beinen und Handtuchhalter rechts
Estructura para lavabo de aluminio 60 cm con patas y toallero dch
Подставка для умывальника из алюминия 60 см с ножками и держателем полотенец справа

Art. 1845

L60 P50 H75 Cm



930,00

STRUCTURE



NROP

WOOD



87

88

89

96

97

Struttura porta lavabo in alluminio 60 cm con gambe e porta asciugamani SX
60 cm aluminium washbasin frame with legs and LH towel rail
Structure porte-lavabo en aluminium 60 cm avec pied et porte-serviette GCH
Waschbeckenuntergestell aus Aluminium, 60 cm, mit Beinen und Handtuchhalter links
Estructura para lavabo de aluminio 60 cm con patas y toallero izq
Подставка для умывальника из алюминия 60 см с ножками и держателем полотенец слева

Art. 1846

L90 P50 H75 Cm



1.000,00

STRUCTURE



NROP

WOOD



87

88

89

96

97

Struttura porta lavabo in alluminio 90 cm con gambe e porta asciugamani DX
90 cm aluminium washbasin frame with legs and RH towel rail
Structure porte-lavabo en aluminium 90 cm avec pied et porte-serviette DTE
Waschbeckenuntergestell aus Aluminium, 90 cm, mit Beinen und Handtuchhalter rechts
Estructura para lavabo de aluminio 90 cm con patas y toallero dch
Подставка для умывальника из алюминия 90 см с ножками и держателем полотенец справа

- Se non viene specificato il lavabo il top viene inviato senza foro - Se si desidera un foro per un lavabo non in lista il costo extra netto è di Euro 50 - I soli lavabi abbinabili sono quelli nel catalogo Scarabeo 2020, salvo diverse disposizioni
- If the washbasin is not indicated, the top is shipped without hole - The additional net cost for a hole in a washbasin that is not in the list is Euro 50 - Only the washbasins contained in the Scarabeo 2020 catalogue can be matched, except where otherwise stated
- Si le type de lavabo n'est pas précisé, le plan est envoyé sans percement - Si vous souhaitez un percement pour un lavabo hors catalogue, 50 euros seront facturés en supplément - Les seuls lavabos combinables sont repris dans le catalogue Scarabeo 2020, sauf mention contraire
- Bei fehlender Angabe des Modells wird das Waschbecken ohne Bohrung geliefert - Für Bohrungen an Waschbecken, die nicht in der Liste enthalten sind, wird ein Zuschlag von 50 Euro berechnet - Nur die Waschbecken aus dem Katalog Scarabeo 2020 sind kombinierbar, sofern nicht anders angegeben
- Si no está especificado el lavabo, la encimera se envía sin orificio - Si se desea un orificio para un lavabo que no figura en la lista, el coste extra neto es de 50 euros - Los únicos lavabos instalables son aquellos del catálogo Scarabeo 2020, salvo en caso de disposiciones diferentes
- Если умывальник не будет указан, столешница будет отправлена без отверстия - Если необходимо выполнить отверстие для умывальника, который не входит в перечень, наценка-нетто составит 50 евро - Сочетаются только умывальники из каталога Scarabeo 2020, за исключением других типов размещения

Art. 1847

L90 P50 H75 Cm



1.000,00

STRUCTURE



NROP

WOOD



87



88



89



96



97

Struttura porta lavabo in alluminio 90 cm con gambe e porta asciugamani SX

90 cm aluminium washbasin frame with legs and LH towel rail

Structure porte-lavabo en aluminium 90 cm avec pied et porte-serviette GCH

Waschbeckenuntergestell aus Aluminium, 90 cm, mit Beinen und Handtuchhalter links

Estructura para lavabo de aluminio 90 cm con patas y toallero izq

Подставка для умывальника из алюминия 90 см с ножками и держателем полотенец слева

Art. 10032

COMPACT TRAP

Sifone compatto in ottone

Brass compact trap

Siphon compact en laiton

Kompakter Siphon aus Messing

Sifón compacto de latón

Компактный сифон из латуни



CR



290,00

NROP



290,00

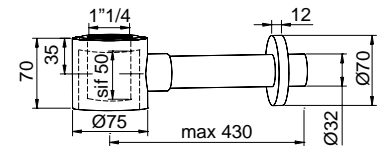

Art. 10009

Sifone tondo in ottone ribassato 1" 1/4 cromato

Cr Brass round trap, shorted 1" 1/4 chromed

Syphon petit culot laiton chromé

Siphon aus verchromtem messing, abgeflacht

Sifón redondo de latón rebajado 1" 1/4 cromado

Сифон круглого сечения 1"1/4 укороченный, из хромированной латуни



CR



115,00

NROP



170,00

ORS



290,00

Art. FR201



FRAME2 COMPOSITION 90NDX _88

1.250,00

- Art. 1846 _NROP _88 - L90 P50 H75 Cm

- Art. 2201 - Ø50 Cm

Lavabo escluso
Washbasin excluded
Lavabo non compris
Waschbecken nicht enthalten
Lavabo excludo
Раковина умывальника не входит в комплект

GLAM Ø39 - Art. 1807_FSNR
Ø39 Cm - WHITE 230,00 - COLORS 415,00 - DECORLAB / DECORART 450,00

Art. FR202



FRAME2 COMPOSITION 90NSX _88

1.400,00

- Art. 1847 _NROP _88 - L90 P50 H75 Cm

- Art. 2205 - 100 x 60 Cm

Lavabo escluso
Washbasin excluded
Lavabo non compris
Waschbecken nicht enthalten
Lavabo excludo
Раковина умывальника не входит в комплект

TEOREMA 2.0 60 - Art. 5101_REV
60 x 40 Cm - WHITE 420,00 - COLORS 600,00 - DECORLAB / DECORART 650,00

Art. FR203



FRAME2 COMPOSITION 60NSX _96

1.180,00

- Art. 1845 _NROP _96 - L60 P50 H75 Cm

- Art. 2201 - Ø50 Cm

Lavabo escluso
Washbasin excluded
Lavabo non compris
Waschbecken nicht enthalten
Lavabo excludo
Раковина умывальника не входит в комплект

GLAM Ø39 - Art. 1807_49
Ø39 Cm - WHITE 230,00 - COLORS 415,00 - DECORLAB / DECORART 450,00

FORI PER LAVABI - HOLES FOR WASHBASINS - ORIFICIOS PARA LAVABOS - ОТВЕРСТИЯ ПОД РАКОВИНЫ УМЫВАЛЬНИКА

ART. 1846 / 1847 = 900 X 500 mm

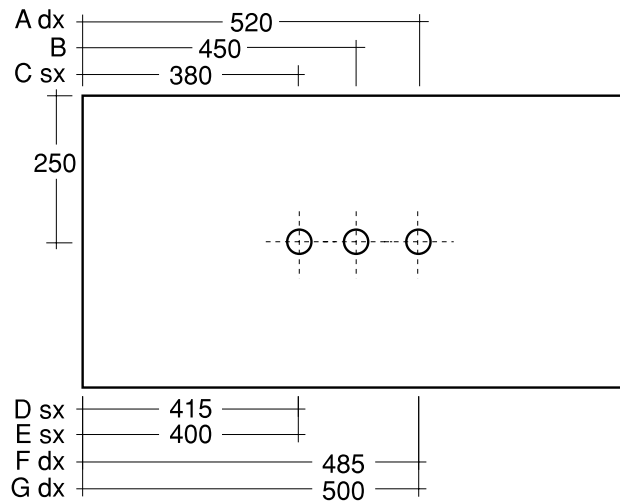

Name	Art.	A dx	B	C sx	D sx	E sx	F dx	G dx
MOON	5501 - 5503 - 5504 - 5507 - 5511	■	■	■				
MOON	5502 - 5505 - 5506 - 5508 - 5509 - 5512		■					
BUCKET	8807 - 8808 - 8809 - 8810 - 8811	■	■	■				
BUTTERFLY	4001 - 4002 - 4003 - 4004	■	■	■				
PLANET	8109 - 8110 - 8111 - 8112	■	■	■				
MOAI	8601 - 8602 - 8610	■	■	■				
NEXT	8047/A - 8047/B - 8306 - 8307 - 8308	■	■	■				
TEOREMA 2.0	5101 - 5108 - 5109 - 5104 - 5105 - 5111 - 5112 - 5114 - 5117	■	■	■				
TEOREMA 2.0	5102 - 5110 - 5115 - 5118 - 5123		■					
TEOREMA	8031 - 8031/R - 8031/R-60 - 8031-40 - 8031-60 - 5001 - 5002	■	■	■				
TEOREMA	8031/R80 - 8031-80 - 5003		■					
GLAM	1802 - 1804 - 1805 - 1810 - 1811	■	■	■				
GLAM	1806 - 1807 - 1808	■	■	■				
GLAM	1801 - 1803 - 1812		■		■		■	
MIZU	9001 - 9002 - 9003 - 9004 - 9005 - 9006 - 9007 - 9008	■	■	■				
FUJI	6001 - 6002 - 6003 - 6004 - 6013 - 6014 - 6015	■	■	■				
ZEFIRO	8201 - 8204 - 8205 - 8206 - 8207	■	■	■				
THIN-LINE	8046 - 8046/R - 8045 - 8044 - 8009 - 8009/R	■	■	■				
THIN-LINE	8010 - 8010/R - 8011 - 8029 - 8029/R - 8030 - 8030/R	■	■	■				
KONG	8051 - 8051/R - 8052 - 8052/R	■	■	■				
KONG	8053 - 8053/R		■					
TSUNAMI	8039 - 8039/R	■	■	■				
SHAPE	8098	■	■	■				
SQUARE	8025/A		■			■		■
SQUARE	8025/B	■	■	■				
LAVABI D'ARREDO	8003 - 8034	■	■	■				

- Se non viene specificato il lavabo il top viene inviato senza foro - Se si desidera un foro per un lavabo non in lista il costo extra netto è di Euro 50 - I soli lavabi abbinabili sono quelli nel catalogo Scarabeo 2020, salvo diverse disposizioni
 - If the washbasin is not indicated, the top is shipped without hole - The additional net cost for a hole in a washbasin that is not in the list is Euro 50 - Only the washbasins contained in the Scarabeo 2020 catalogue can be matched, except where otherwise stated
 - Si le type de lavabo n'est pas précisé, le plan est envoyé sans perçement - Si vous souhaitez un perçement pour un lavabo hors catalogue, 50 euros seront facturés en supplément - Les seuls lavabos combinables sont repris dans le catalogue Scarabeo 2020, sauf mention contraire
 - Bei fehlender Angabe des Modells wird das Waschbecken ohne Bohrung geliefert - Für Bohrungen an Waschbecken, die nicht in der Liste enthalten sind, wird ein Zuschlag von 50 Euro berechnet - Nur die Waschbecken aus dem Katalog Scarabeo 2020 sind kombinierbar, sofern nicht anders angegeben
 - Si no está especificado el lavabo, la encimera se envía sin orificio - Si se desea un orificio para un lavabo que no figura en la lista, el coste extra neto es de 50 euros - Los únicos lavabos instalables son aquellos del catálogo Scarabeo 2020, salvo en caso de disposiciones diferentes
 - Если умывальник не будет указан, столешница будет отправлена без отверстия - Если необходимо выполнить отверстие для умывальника, который не входит в перечень, наценка-нетто составит 50 евро - Сочетаются только умывальники из каталога Scarabeo 2020, за исключением других типов размещения

Art. 2100

L70 P50 H50 Cm



Base per lavabo 2 cassetti
 2-drawer washbasin vanity unit
 Élément bas pour lavabo 2 tiroirs
 Waschtisch mit 2 schubladen
 Mueble bajo para lavabo 2 cajones
 Шкафчик умывальника с 2 ящиками

Top escluso - Specificare Art. 2110
 Top excluded - Specify Art 2110
 Plan non compris - Préciser Art 2110
 Top nicht enthalten - Art 2112 angeben
 Encimera excluido - Especificar Art 2110
 Столешницы не входит в комплект - указать артикул 2110

835,00

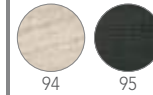

870,00



TWO-TONE 860,00



Art. 2101

L95 P50 H50 Cm



Base per lavabo 2 cassetti
 2-drawer washbasin vanity unit
 Élément bas pour lavabo 2 tiroirs
 Waschtisch mit 2 schubladen
 Mueble bajo para lavabo 2 cajones
 Шкафчик умывальника с 2 ящиками

Top escluso - Specificare Art. 2110
 Top excluded - Specify Art 2110
 Plan non compris - Préciser Art 2110
 Top nicht enthalten - Art 2112 angeben
 Encimera excluido - Especificar Art 2110
 Столешницы не входит в комплект - указать артикул 2110

920,00

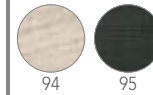

955,00



TWO-TONE 940,00



Art. 2102

L120 P50 H50 Cm



Base per lavabo 2 cassetti
 2-drawer washbasin vanity unit
 Élément bas pour lavabo 2 tiroirs
 Waschtisch mit 2 schubladen
 Mueble bajo para lavabo 2 cajones
 Шкафчик умывальника с 2 ящиками

Top escluso - Specificare Art. 2110
 Top excluded - Specify Art 2110
 Plan non compris - Préciser Art 2110
 Top nicht enthalten - Art 2112 angeben
 Encimera excluido - Especificar Art 2110
 Столешницы не входит в комплект - указать артикул 2110

1.090,00

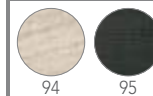

1.140,00



TWO-TONE 1.140,00



- Se non viene specificato il lavabo il top viene inviato senza foro - Se si desidera un foro per un lavabo non in lista il costo extra netto è di Euro 50 - I soli lavabi abbinabili sono quelli nel catalogo Scarabeo 2020, salvo diverse disposizioni
 - If the washbasin is not indicated, the top is shipped without hole - The additional net cost for a hole in a washbasin that is not in the list is Euro 50 - Only the washbasins contained in the Scarabeo 2020 catalogue can be matched, except where otherwise stated
 - Si le type de lavabo n'est pas précisé, le plan est envoyé sans perçement - Si vous souhaitez un perçement pour un lavabo hors catalogue, 50 euros seront facturés en supplément - Les seuls lavabos combinables sont repris dans le catalogue Scarabeo 2020, sauf mention contraire
 - Bei fehlender Angabe des Modells wird das Waschbecken ohne Bohrung geliefert - Für Bohrungen an Waschbecken, die nicht in der Liste enthalten sind, wird ein Zuschlag von 50 Euro berechnet - Nur die Waschbecken aus dem Katalog Scarabeo 2020 sind kombinierbar, sofern nicht anders angegeben
 - Si no está especificado el lavabo, la encimera se envía sin orificio - Si se desea un orificio para un lavabo que no figura en la lista, el coste extra neto es de 50 euros - Los únicos lavabos instalables son aquellos del catálogo Scarabeo 2020, salvo en caso de disposiciones diferentes
 - Если умывальник не будет указан, столешница будет отправлена без отверстия - Если необходимо выполнить отверстие для умывальника, который не входит в перечень, наценка-нетто составит 50 евро - Сочетаются только умывальники из каталога Scarabeo 2020, за исключением других типов размещения

Art. 2110

L Im - P51 H1,8 Cm

ml - lm **185,00**

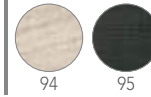

ml - lm **190,00**



Top per basi

Vanity unit top

Plan pour éléments bas

Top für waschtische

Encimera para muebles bajos

Столешница для шкафчика умывальника

Art. 2103SX

L25 P50 H50 Cm

300,00

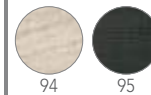

325,00



TWO-TONE 310,00



Base aggiuntiva 1 anta - SX con 1 ripiano in vetro

Additional 1-door vanity unit – LH with glass shelf

Élément bas supplémentaire 1 battant – GCH avec plateau en verre

Zusätzlicher waschtisch mit 1 tür links und top aus glas

Mueble bajo adicional 1 puerta – IZQ con estante de vidrio

Шкафчик дополнительный с 1 левосторонней дверцей и стеклянной полкой

Top escluso - Specificare Art. 2110

Top excluded - Specify Art 2110

Plan non compris - Préciser Art 2110

Top nicht enthalten - Art 2112 angeben

Encimera excluido - Especificar Art 2110

Столешницы не входит в комплект - указать артикул 2110

Art. 2103DX

L25 P50 H50 Cm

300,00

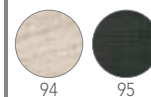

325,00



TWO-TONE 310,00



Base aggiuntiva 1 anta - DX con 1 ripiano in vetro

Additional 1-door vanity unit – RH with glass shelf

Élément bas supplémentaire 1 battant – DTE avec plateau en verre

Zusätzlicher waschtisch mit 1 tür rechts und top aus glas

Mueble bajo adicional 1 puerta – DCH con estante de vidrio

Шкафчик дополнительный с 1 правосторонней дверцей и стеклянной полкой

Top escluso - Specificare Art. 2110

Top excluded - Specify Art 2110

Plan non compris - Préciser Art 2110

Top nicht enthalten - Art 2112 angeben

Encimera excluido - Especificar Art 2110

Столешницы не входит в комплект - указать артикул 2110

Art. 2104SX

L50 P50 H50 Cm



Base aggiuntiva 1 anta - SX con 1 ripiano in vetro
 Additional 1-door vanity unit – LH with glass shelf
 Élément bas supplémentaire 1 battant – GCH avec plateau en verre
 Zusätzlicher waschtisch mit 1 tür links und top aus glas
 Mueble bajo adicional 1 puerta – IZQ con estante de vidrio
 Шкафчик дополнительный с 1 левосторонней дверцей и стеклянной полкой

370,00

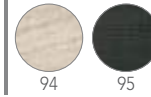

390,00



TWO-TONE 380,00



Top escluso - Specificare Art. 2110
 Top excluded - Specify Art 2110
 Plan non compris - Préciser Art 2110
 Top nicht enthalten - Art 2112 angeben
 Encimera excluido - Especificar Art 2110
 Столешницы не входит в комплект - указать артикул 2110

Art. 2104DX

L50 P50 H50 Cm



Base aggiuntiva 1 anta - DX con 1 ripiano in vetro
 Additional 1-door vanity unit – RH with glass shelf
 Élément bas supplémentaire 1 battant – DTE avec plateau en verre
 Zusätzlicher waschtisch mit 1 tür rechts und top aus glas
 Mueble bajo adicional 1 puerta – DCH con estante de vidrio
 Шкафчик дополнительный с 1 правосторонней дверцей и стеклянной полкой

370,00

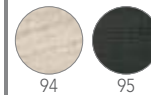

390,00



TWO-TONE 380,00



Top escluso - Specificare Art. 2110
 Top excluded - Specify Art 2110
 Plan non compris - Préciser Art 2110
 Top nicht enthalten - Art 2112 angeben
 Encimera excluido - Especificar Art 2110
 Столешницы не входит в комплект - указать артикул 2110

Art. 2105

L25 P50 H50 Cm



Base aggiuntiva a giorno con 1 ripiano in legno
 Additional open-fronted vanity unit with 1 wooden shelf
 Élément bas supplémentaire ajouré avec 1 plateau en bois
 Zusätzlicher waschtisch, offen, mit 1 ablage aus holz
 Mueble bajo adicional abierto con 1 estante de madera
 Шкафчик дополнительный открытый с 1 деревянной полкой

190,00

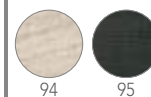

200,00



Top escluso - Specificare Art. 2110
 Top excluded - Specify Art 2110
 Plan non compris - Préciser Art 2110
 Top nicht enthalten - Art 2112 angeben
 Encimera excluido - Especificar Art 2110
 Столешницы не входит в комплект - указать артикул 2110

Art. 2107

L25 P20,8 H50 Cm



250,00

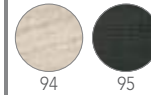

94

95

275,00



93

Pensile a giorno con 1 ripiano in legno

Open-fronted wall unit with 1 wooden shelf

Élément suspendu ajouré 1 plateau en bois

Offener hängeschränk mit 1 ablage aus holz

Mueble alto abierto 1 estante de madera

Навесной шкаф открытый с 1 деревянной полкой

Art. 2108SX

L25 P20,8 H50 Cm



250,00

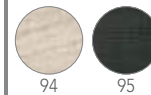

94

95

275,00



93

TWO-TONE

260,00



F1

F2

F3

F4

Pensile 1 anta - SX con 1 ripiano in vetro

1-door wall unit - LH with 1 glass shelf

Élément suspendu 1 porte – GCH avec 1 plateau en verre

Hängeschränk mit 1 tür – links mit 1 glasablage

Mueble alto 1 puerta - IZQ con 1 estante de vidrio

Навесной шкаф с 1 левосторонней дверцей и 1 стеклянной полкой

Art. 2108DX

L25 P20,8 H50 Cm



250,00

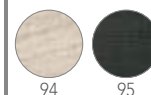

94

95

275,00



93

TWO-TONE

260,00



F1

F2

F3

F4

Pensile 1 anta - DX con 1 ripiano in vetro

1-door wall unit - RH with 1 glass shelf

Élément suspendu 1 porte – DTE avec 1 plateau en verre

Hängeschränk mit 1 tür – rechts und 1 glasablage

Mueble alto 1 puerta - DCH con 1 estante de vidrio

Навесной шкаф с 1 правосторонней дверцей и 1 стеклянной полкой

Art. 2109

L25 P20,8 H75 Cm



300,00

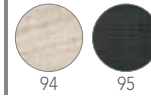

94

95

320,00



93

Pensile a giorno con 1 ripiano in legno

Open-fronted wall unit with 1 wooden shelf

Élément suspendu ajouré 1 plateau en bois

Offener hängeschränk mit 1 ablage aus holz

Mueble alto abierto 1 estante de madera

Навесной шкаф открытый с 1 деревянной полкой

Art. 2110SX

L25 P20,8 H75 Cm



300,00

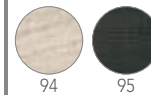

94

95

325,00



93

TWO-TONE

310,00



F1

F2

F3

F4

Pensile 1 anta - SX con 2 ripiani in vetro

1-door wall unit - LH with 2 glass shelves

Élément suspendu 1 porte – GCH avec 2 plateaux en verre

Hängeschränk mit 1 tür – links und 2 glasablagen

Mueble alto 1 puerta - IZQ con 2 estantes de vidrio

Навесной шкаф с 1 левосторонней дверцей и 2 стеклянными полками

Art. 2110DX

L25 P20,8 H75 Cm



300,00

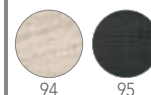

94

95

325,00



93

TWO-TONE

310,00



F1

F2

F3

F4

Pensile 1 anta - DX con 2 ripiani in vetro

1-door wall unit - RH with 2 glass shelves

Élément suspendu 1 porte – DTE avec 2 plateaux en verre

Hängeschränk mit 1 tür – rechts und 2 glasablagen

Mueble alto 1 puerta - DCH con 2 estantes de vidrio

Навесной шкаф с 1 правосторонней дверцей и 2 стеклянными полками

Art. 2118

L50 P20,8 H75 Cm



Pensile a 2 ante con 2 ripiani in vetro

2-door wall unit with 2 glass shelves

Élément suspendu 2 portes – dte avec 2 plateaux en verre

Hängeschränk mit 2 türen und 2 glasablagen

Mueble alto 2 puertas con 2 estantes de vidrio

Навесной шкаф с 2 дверцами и 2 стеклянными полками

435,00

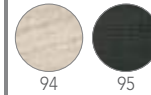

94

95

470,00



93

TWO-TONE

460,00



F1

F2

F3

F4

Art. 10032

COMPACT TRAP



Sifone compatto in ottone

Brass compact trap

Siphon compact en laiton

Kompakter Siphon aus Messing

Sifón compacto de latón

Компактный сифон из латуни

CR ● 290,00

NROP ● 290,00

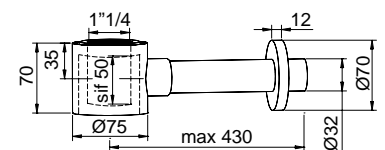

Art. 10029

SPACE SAVING SINK SIPHON



Sifone per lavabo salvaspazio

Space saving sink siphon

Siphon pour lavabo dimension reduite

Platzsparender Spülensiphon

Sifón de fregadero que ahorra espacio

Сифон для экономии пространства

-- 40,00

Art. 2111

MIRROR - 70 x 50 Cm



Specchio
 Mirror
 Miroir
 Spiegel
 Espejo
 Зеркало

-- 255,00

Con presa e interruttore
 With socket and switch
 Avec prise et interrupteur
 Mit schalteranschluss
 Con toma e interruptor
 С розеткой и выключателем

Art. 2112

MIRROR - 95 x 50 Cm



Specchio
 Mirror
 Miroir
 Spiegel
 Espejo
 Зеркало

-- 300,00

Con presa e interruttore
 With socket and switch
 Avec prise et interrupteur
 Mit schalteranschluss
 Con toma e interruptor
 С розеткой и выключателем

Art. 2113

MIRROR - 120 x 50 Cm



Specchio
 Mirror
 Miroir
 Spiegel
 Espejo
 Зеркало

-- 350,00

Con presa e interruttore
 With socket and switch
 Avec prise et interrupteur
 Mit schalteranschluss
 Con toma e interruptor
 С розеткой и выключателем

Art. 2114

MIRROR - 70 x 75 Cm



Specchio
 Mirror
 Miroir
 Spiegel
 Espejo
 Зеркало

-- 290,00

Con presa e interruttore
 With socket and switch
 Avec prise et interrupteur
 Mit schalteranschluss
 Con toma e interruptor
 С розеткой и выключателем

Art. 2115

MIRROR - 95 x 75 Cm



Specchio
 Mirror
 Miroir
 Spiegel
 Espejo
 Зеркало

--

345,00

Con presa e interruttore
 With socket and switch
 Avec prise et interrupteur
 Mit schalteranschluss
 Con toma e interruptor
 С розеткой и выключателем

Art. 2116

MIRROR - 120 x 75 Cm



Specchio
 Mirror
 Miroir
 Spiegel
 Espejo
 Зеркало

--

440,00

Con presa e interruttore
 With socket and switch
 Avec prise et interrupteur
 Mit schalteranschluss
 Con toma e interruptor
 С розеткой и выключателем

Art. 2117

LED LAMP



Lampada LED
 LED lamp
 Lampe LED
 LED-leuchte
 Lámpara LED
 Светильник светодиодный

--

120,00

Art. PHRM1

PHORMA COMPOSITION 120_2100
2.138,00

- Art. 2100 _95 - L70 P50 H50 cm
- Art. 2110 _93 - L120 - H1,8 cm
- Art. 2105 _93 x2 - L25 P50 H50 cm
- Art. 2109 _95 - L25 P20,8 H75 cm
- Art. 2111 - 70 x 50 cm
- Art. 2117

Lavabo escluso
 Washbasin excluded
 Lavabo non compris
 Waschbecken nicht enthalten
 Lavabo excluido
 Раковина умывальника не входит в комплект

TEOREMA 2.0 60R Art. 5105
 60 x 46 cm - WHITE 470,00 - COLORS 670,00 - DECORLAB 700,00

Art. PHRM2

PHORMA COMPOSITION 145_2101
2.233,25

- Art. 2101 _94 - L95 P50 H50 cm
- Art. 2110 _94 - L145 - H1,8 cm
- Art. 2104DX _94 - L50 P50 H50 cm
- Art. 2109 _94 - L25 P20,8 H75 cm
- Art. 2111 - 70 x 50 cm
- Art. 2117

Lavabo escluso
 Washbasin excluded
 Lavabo non compris
 Waschbecken nicht enthalten
 Lavabo excluido
 Раковина умывальника не входит в комплект

TEOREMA 2.0 60R Art. 5105
 60 x 46 cm - WHITE 470,00 - COLORS 670,00 - DECORLAB / DECORART 700,00

Art. PHRM3

PHORMA COMPOSITION 170_2102
2.913,00

- Art. 2102 _F1 - L120 P50 H50 Cm
- Art. 2110 _93 - L170 - H1,8 cm
- Art. 2105 _93 - x2 L25 P50 H50 cm
- Art. 2109 _93 - x2 L25 P20,8 H75 cm
- Art. 2114 - 70 x 75 cm
- Art. 2117

Lavabo escluso
 Washbasin excluded
 Lavabo non compris
 Waschbecken nicht enthalten
 Lavabo excluido
 Раковина умывальника не входит в комплект

GLAM 76/R Art. 1801
 76 x 38 cm - WHITE 470,00 - COLORS 625,00 - DECORART 700,00

Art. PHRM4



PHORMA COMPOSITION 170_2102b

2.913,00

- Art. 2102_93 - L120 P50 H50 Cm
- Art. 2110_93 - L170 - H1,8 cm
- Art. 2105_93 x2 - L25 P50 H50 cm
- Art. 2109_93 x2 - L25 P20,8 H75 cm
- Art. 2114 - 70 x 75 cm
- Art. 2117

Lavabo escluso
Washbasin excluded
Lavabo non compris
Waschbecken nicht enthalten
Lavabo excluido
Раковина умывальника не входит в комплект

GLAM 76/R Art. 1801
76 x 38 cm - WHITE 410,00 - COLORS 625,00 - DECORART 700,00

Art. PHRM5



PHORMA COMPOSITION 170_2101

2.909,50

- Art. 2101_95 - L95 P50 H50 cm
- Art. 2110_95 - L170 - H1,8 cm
- Art. 2105_95 x2 - L25 P50 H50 cm
- Art. 2103DX_95 - L25 P50 H50 cm
- Art. 2118_95 - L50 P20,8 H75 cm
- Art. 2116 - 120 x 75 cm
- Art. 2117

Lavabo escluso
Washbasin excluded
Lavabo non compris
Waschbecken nicht enthalten
Lavabo excluido
Раковина умывальника не входит в комплект

TEOREMA 2.0 80 Art. 5102_49
80 x 40 cm - WHITE 470,00 - COLORS 650,00 - DECORLAB / DECORART 700,00

Art. PHRM6



PHORMA COMPOSITION 215_2100

4.317,75

- Art. 2100_95 x2 - L70 P50 H50 cm
- Art. 2110_95 - L215 - H1,8 cm
- Art. 2105_93 x3 - L25 P50 H50 cm
- Art. 2110DX_95 - L25 P20,8 H75 cm
- Art. 2110SX_95 - L25 P20,8 H75 cm
- Art. 2109_95 - L25 P20,8 H75 cm
- Art. 2111 x2 - 70 x 50 cm
- Art. 2117 x2

Lavabo escluso
Washbasin excluded
Lavabo non compris
Waschbecken nicht enthalten
Lavabo excluido
Раковина умывальника не входит в комплект

TEOREMA 2.0 60R Art. 5105_X2
60 x 46 cm - WHITE 470,00 - COLORS 670,00 - DECORLAB / DECORART 700,00

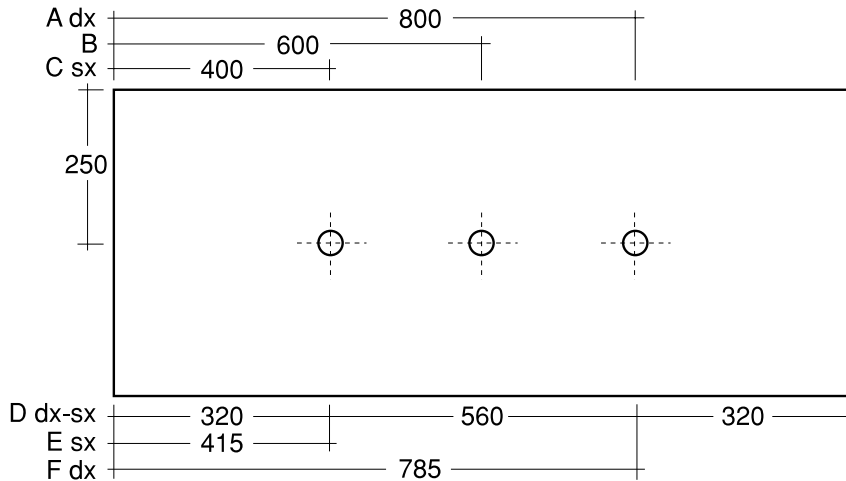

Name	Art.	A dx	B	C sx	D dx-sx
MOON	5501 - 5502 - 5503 - 5504 - 5505 - 5507 - 5508 - 5511 - 5512		■	■	■
MOON	5506 - 5509		■		
BUCKET	8807 - 8808 - 8809 - 8810 - 8811	■	■	■	■
BUTTERFLY	4001 - 4003	■	■	■	■
BUTTERFLY	4002 - 4004	■	■	■	
PLANET	8109 - 8111	■	■	■	
PLANET	8110 - 8112	■	■	■	■
MOAI	8601 - 8602 - 8610	■	■	■	
NEXT	8047/A - 8047/B - 8306 - 8307 - 8308	■	■	■	■
TEOREMA 2.0	5101 - 5104 - 5105 - 5110 - 5111 - 5112 - 5114 - 5115 - 5117 - 5118 - 5123			■	■ ■
TEOREMA 2.0	5108 - 5109	■	■	■	■
TEOREMA 2.0	5102 - 5106/R-100/A-B - 5119 - 5120 - 5124		■		
TEOREMA	8031 - 8031/R - 8031/R-40 - 8031/R-60 - 8031-40 - 5001 - 5002	■	■	■	■
TEOREMA	8031-60 - 8031/R-80 - 5003	■	■	■	
TEOREMA	8031-80 - 8031/R-100/A-B		■		
GLAM	1806 - 1807 - 1808	■	■	■	■
GLAM	1802 - 1801 - 1803 - 1804 - 1805 - 1810 - 1812	■	■	■	
GLAM	1803		■		
MIZU	9002 - 9004 - 9005 - 9006	■	■	■	■
MIZU	9001 - 9003 - 9007 - 9008	■	■	■	
FUJI	6001 - 6003 - 6013	■	■	■	■
FUJI	6002 - 6004 - 6014 - 6015	■	■	■	
ZEFIRO	8201 - 8204 - 8205 - 8206 - 8207	■	■	■	
THIN-LINE	8046 - 8046/R - 8045	■	■	■	
THIN-LINE	8044 - 8009 - 8009/R - 8010 - 8010/R	■	■	■	■
THIN-LINE	8011 - 8029 - 8029/R - 8030 - 8030/R	■	■	■	■
KONG	8051 - 8051/R	■	■	■	■
KONG	8052 - 8052/R	■	■	■	
KONG	8053 - 8053/R - 8054 - 8054/R		■		
TSUNAMI	8038 - 8038/R		■		
TSUNAMI	8039 - 8039/R	■	■	■	
SHAPE	8098	■	■	■	■
SQUARE	8025/A - 8025/B	■	■	■	
SQUARE	8025/A - 8025/B	■	■	■	■
LAVABI D'ARREDO	8003 - 8034	■	■	■	■

- Se non viene specificato il lavabo il top viene inviato senza foro - Se si desidera un foro per un lavabo non in lista il costo extra netto è di Euro 50 - I soli lavabi abbinabili sono quelli nel catalogo Scarabeo 2020, salvo diverse disposizioni
 - If the washbasin is not indicated, the top is shipped without hole - The additional net cost for a hole in a washbasin that is not in the list is Euro 50 - Only the washbasins contained in the Scarabeo 2020 catalogue can be matched, except where otherwise stated
 - Si le type de lavabo n'est pas précisé, le plan est envoyé sans perçement - Si vous souhaitez un perçement pour un lavabo hors catalogue, 50 euros seront facturés en supplément - Les seuls lavabos combinables sont repris dans le catalogue Scarabeo 2020, sauf mention contraire
 - Bei fehlender Angabe des Modells wird das Waschbecken ohne Bohrung geliefert - Für Bohrungen an Waschbecken, die nicht in der Liste enthalten sind, wird ein Zuschlag von 50 Euro berechnet - Nur die Waschbecken aus dem Katalog Scarabeo 2020 sind kombinierbar, sofern nicht anders angegeben
 - Si no está especificado el lavabo, la encimera se envía sin orificio - Si se desea un orificio para un lavabo que no figura en la lista, el coste extra neto es de 50 euros - Los únicos lavabos instalables son aquellos del catálogo Scarabeo 2020, salvo en caso de disposiciones diferentes
 - Если умывальник не будет указан, столешница будет отправлена без отверстия - Если необходимо выполнить отверстие для умывальника, который не входит в перечень, наценка-нетто составит 50 евро - Сочетаются только умывальники из каталога Scarabeo 2020, за исключением других типов размещения

ART. 2101 = 950 X 500 mm

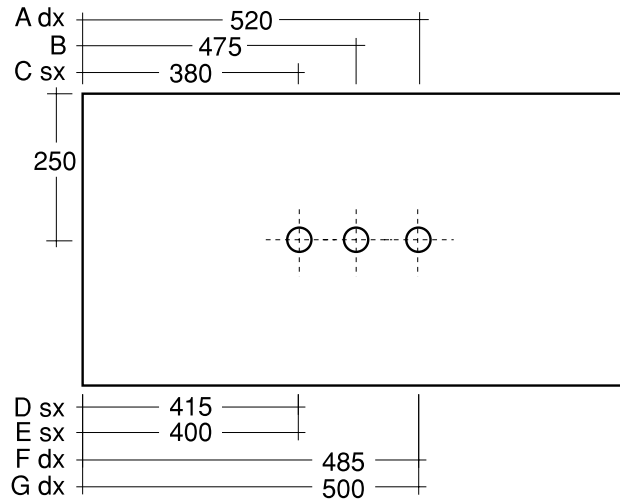

Name	Art.	A dx	B	C sx	D sx	E sx	F dx	G dx
MOON	5501 - 5503 - 5504 - 5507 - 5511	■	■	■				
MOON	5502 - 5505 - 5506 - 5508 - 5509 - 5512		■					
BUCKET	8807 - 8808 - 8809 - 8810 - 8811	■	■	■				
BUTTERFLY	4001 - 4002 - 4003 - 4004	■	■	■				
PLANET	8109 - 8110 - 8111 - 8112	■	■	■				
MOAI	8601 - 8602 - 8610	■	■	■				
NEXT	8047/A - 8047/B - 8306 - 8307 - 8308	■	■	■				
TEOREMA 2.0	5101 - 5108 - 5109 - 5104 - 5105 - 5111 - 5112 - 5114 - 5117	■	■	■				
TEOREMA 2.0	5102 - 5110 - 5115 - 5118 - 5123		■					
TEOREMA	8031 - 8031/R - 8031/R-60 - 8031-40 - 8031-60 - 5001 - 5002	■	■	■				
TEOREMA	8031/R80 - 8031-80 - 5003		■					
GLAM	1802 - 1804 - 1805 - 1810 - 1811	■	■	■				
GLAM	1806 - 1807 - 1808	■	■	■				
GLAM	1801 - 1803 - 1812		■		■		■	
MIZU	9001 - 9002 - 9003 - 9004 - 9005 - 9006 - 9007 - 9008	■	■	■				
FUJI	6001 - 6002 - 6003 - 6004 - 6013 - 6014 - 6015	■	■	■				
ZEFIRO	8201 - 8204 - 8205 - 8206 - 8207	■	■	■				
THIN-LINE	8046 - 8046/R - 8045 - 8044 - 8009 - 8009/R	■	■	■				
THIN-LINE	8010 - 8010/R - 8011 - 8029 - 8029/R - 8030 - 8030/R	■	■	■				
KONG	8051 - 8051/R - 8052 - 8052/R	■	■	■				
KONG	8053 - 8053/R		■					
TSUNAMI	8039 - 8039/R	■	■	■				
SHAPE	8098	■	■	■				
SQUARE	8025/A		■			■		■
SQUARE	8025/B	■	■	■				
LAVABI D'ARREDO	8003 - 8034	■	■	■				

- Se non viene specificato il lavabo il top viene inviato senza foro - Se si desidera un foro per un lavabo non in lista il costo extra netto è di Euro 50 - I soli lavabi abbinabili sono quelli nel catalogo Scarabeo 2020, salvo diverse disposizioni
 - If the washbasin is not indicated, the top is shipped without hole - The additional net cost for a hole in a washbasin that is not in the list is Euro 50 - Only the washbasins contained in the Scarabeo 2020 catalogue can be matched, except where otherwise stated
 - Si le type de lavabo n'est pas précisé, le plan est envoyé sans perçement - Si vous souhaitez un perçement pour un lavabo hors catalogue, 50 euros seront facturés en supplément - Les seuls lavabos combinables sont repris dans le catalogue Scarabeo 2020, sauf mention contraire
 - Bei fehlender Angabe des Modells wird das Waschbecken ohne Bohrung geliefert - Für Bohrungen an Waschbecken, die nicht in der Liste enthalten sind, wird ein Zuschlag von 50 Euro berechnet - Nur die Waschbecken aus dem Katalog Scarabeo 2020 sind kombinierbar, sofern nicht anders angegeben
 - Si no está especificado el lavabo, la encimera se envía sin orificio - Si se desea un orificio para un lavabo que no figura en la lista, el coste extra neto es de 50 euros - Los únicos lavabos instalables son aquellos del catálogo Scarabeo 2020, salvo en caso de disposiciones diferentes
 - Если умывальник не будет указан, столешница будет отправлена без отверстия - Если необходимо выполнить отверстие для умывальника, который не входит в перечень, наценка-нетто составит 50 евро - Сочетаются только умывальники из каталога Scarabeo 2020, за исключением других типов размещения

Art. 2201

ROUND MIRROR - BACKLIT - Ø50 Cm



Specchio tondo retroilluminato
 Round backlit mirror
 Miroir rétroéclairé rond
 Runder spiegel hinten beleuchtet
 Espejo retroiluminado redondo
 Зеркало с подсветкой круглое

--

250,00

Con presa e interruttore
 With socket and switch
 Avec prise et interrupteur
 Mit schalteranschluss
 Con toma e interruptor
 С розеткой и выключателем

Art. 2202

ROUND MIRROR - BACKLIT - Ø70 Cm



Specchio tondo retroilluminato
 Round backlit mirror
 Miroir rétroéclairé rond
 Runder spiegel hinten beleuchtet
 Espejo retroiluminado redondo
 Зеркало с подсветкой круглое

--

330,00

Con presa e interruttore
 With socket and switch
 Avec prise et interrupteur
 Mit schalteranschluss
 Con toma e interruptor
 С розеткой и выключателем

Art. 2203

RECTANGULAR MIRROR - BACKLIT - 60 x 60 Cm



Specchio rettangolare retroilluminato
 Rectangular backlit mirror
 Miroir rétroéclairé rectangulaire
 Rechteckiger spiegel hinten beleuchtet
 Espejo retroiluminado rectangular
 Зеркало с подсветкой прямоугольное

--

310,00

Con presa e interruttore
 With socket and switch
 Avec prise et interrupteur
 Mit schalteranschluss
 Con toma e interruptor
 С розеткой и выключателем

Art. 2204

RECTANGULAR MIRROR - BACKLIT - 80 x 60 Cm



Specchio rettangolare retroilluminato
 Rectangular backlit mirror
 Miroir rétroéclairé rectangulaire
 Rechteckiger spiegel hinten beleuchtet
 Espejo retroiluminado rectangular
 Зеркало с подсветкой прямоугольное

--

360,00

Con presa e interruttore
 With socket and switch
 Avec prise et interrupteur
 Mit schalteranschluss
 Con toma e interruptor
 С розеткой и выключателем

Art. 2205

RECTANGULAR MIRROR - BACKLIT - 100 x 60 Cm

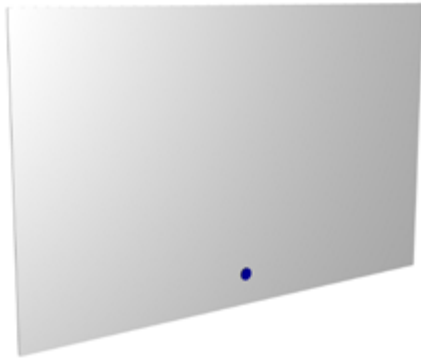

Specchio rettangolare retroilluminato
 Rectangular backlit mirror
 Miroir rétroéclairé rectangulaire
 Rechteckiger spiegel hinten beleuchtet
 Espejo retroiluminado rectangular
 Зеркало с подсветкой прямоугольное

-- **400,00**

Con presa e interruttore
 With socket and switch
 Avec prise et interrupteur
 Mit schalteranschluss
 Con toma e interruptor
 С розеткой и выключателем

Art. 2206

OVAL MIRROR - BACKLIT - 70 x 40 Cm

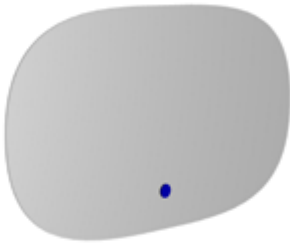

Specchio ovale retroilluminato
 Oval backlit mirror
 Miroir rétroéclairé ovale
 Ovaler spiegel hinten beleuchte
 Espejo retroiluminado ovalado
 Зеркало с подсветкой Овальное

-- **320,00**

Con presa e interruttore
 With socket and switch
 Avec prise et interrupteur
 Mit schalteranschluss
 Con toma e interruptor
 С розеткой и выключателем

Art. 2207

OVAL MIRROR - BACKLIT - 100 x 45 Cm

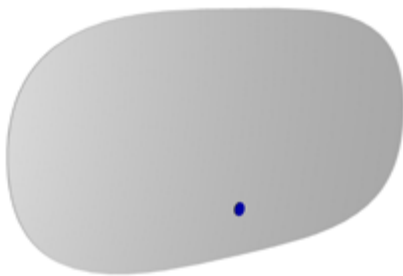

Specchio ovale retroilluminato
 Oval backlit mirror
 Miroir rétroéclairé ovale
 Ovaler spiegel hinten beleuchte
 Espejo retroiluminado ovalado
 Зеркало с подсветкой Овальное

-- **385,00**

Con presa e interruttore
 With socket and switch
 Avec prise et interrupteur
 Mit schalteranschluss
 Con toma e interruptor
 С розеткой и выключателем

Art. 2208

OVAL MIRROR - BACKLIT - 120 x 45 Cm

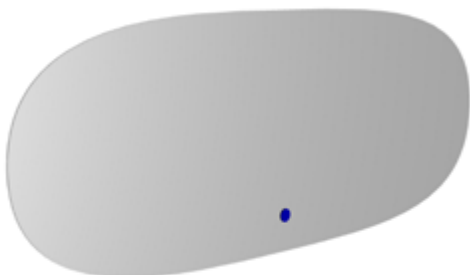

Specchio ovale retroilluminato
 Oval backlit mirror
 Miroir rétroéclairé ovale
 Ovaler spiegel hinten beleuchte
 Espejo retroiluminado ovalado
 Зеркало с подсветкой Овальное

-- **420,00**

Con presa e interruttore
 With socket and switch
 Avec prise et interrupteur
 Mit schalteranschluss
 Con toma e interruptor
 С розеткой и выключателем

Art. 2209



Resistenza antiappannamento 12V
 12V anti-fog resistance
 Résistance anti-buée 12V
 Kondensschutz-Widerstand 12 V
 Resistencia antiempañamiento 12V
 Обогреватель для зеркала 12 В

-- 85,00

Art. 2210



Impianto bluetooth per specchio
 Bluetooth system for mirror
 Installation Bluetooth pour miroir
 Bluetooth-System für Spiegel
 Sistema Bluetooth para espejo
 Устройство Bluetooth для зеркала

-- 245,00

Art. 2404



ABLE - 90 x 50 Cm

Specchio con mensole,
 Orizzontale / Verticale
 Mirror with shelves, Horizontal / Vertical
 Miroir avec étagères, horizontale/verticale
 Spiegel mit Ablagen, horizontal/vertikal
 Espejo con repisas, horizontal/vertical
 Зеркало с полками, горизонтальное или вертикальное

-- 680,00



Art. 2403



ABLE - 90 x 50 Cm

Specchio senza mensole,
 Orizzontale / Verticale
 Mirror without shelves, Horizontal / Vertical
 Miroir sans étagères, horizontale/verticale
 Spiegel ohne Ablagen, horizontal/vertikal
 Espejo sin repisas, horizontal/vertical
 Зеркало без полок, горизонтальное или вертикальное

-- 570,00

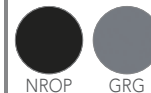

Art. 2301

FOLD - L53,5 H60 Cm



Specchio tondo con mensola
Round mirror with shelf
Miroir rond avec étagère
Runder Spiegel mit Ablage
Espejo redondo con repisa
Зеркало круглое с полкой

310,00



Art. 2302

FOLD - L51 H82 Cm



Specchio in tubolare tondo
con mensola e porta bicchiere
Tubular round mirror with shelf
and glass holder
Miroir avec tube rond, étagère
et porte-gobelet
Spiegel mit Rahmen aus rundem Rohr,
Ablage und Becherhalter
Espejo tubular redondo con repisa
y soporte para vaso
Зеркало круглое из трубчатого профиля
с полкой и подстаканником

345,00



Art. 2304

FOLD - L37 P8 H25 Cm



Specchio contenitore a muro
apertura laterale
Mirror with wall container
and lateral opening
Miroir avec caisson mural
ouverture latérale
Spiegelschrank mit seitlicher Öffnung
Espejo contenedor de pared apertura lateral
Настенный зеркальный шкафчик,
открывающийся сбоку

185,00



Art. 2704

DIVA - L45 H90 Cm

Specchio con porta asciugamano,
mensola, applique integrata

Mirror with towel rail, shelf,
and built-in wall lamp

Miroir avec porte-serviette,
tablette, applique intégrée

Spiegel mit Handtuchhalter,
Ablage und integrierter Leuchte

Espejo con toallero, repisa,
aplique integrado

Зеркало с держателем для полотенца,
полкой и встроенным светильником бра

615,00



Art. 1842

RECTANGULAR MIRROR - 80 x 70 Cm



Specchio rettangolare
 Rectangular mirror
 Miroir rectangulaire
 Rechteckiger spiegel
 Espejo rectangular
 Зеркало прямоугольное

--

280,00

Art. 1841

ROUND MIRROR - Ø50 Cm



Specchio tondo
 Round mirror
 Miroir rond
 Runder spiegel
 Espejo redondo
 Зеркало круглое

--

220,00

Art. 1843

ROUND MIRROR - Ø75 Cm



Specchio tondo
 Round mirror
 Miroir rond
 Runder spiegel
 Espejo redondo
 Зеркало круглое

--

280,00

Art. 2111

MIRROR - 70 x 50 Cm



Specchio
Mirror
Miroir
Spiegel
Espejo
Зеркало

--

255,00

Con presa e interruttore
With socket and switch
Avec prise et interrupteur
Mit schalteranschluss
Con toma e interruptor
С розеткой и выключателем

Art. 2112

MIRROR - 95 x 50 Cm



Specchio
Mirror
Miroir
Spiegel
Espejo
Зеркало

--

300,00

Con presa e interruttore
With socket and switch
Avec prise et interrupteur
Mit schalteranschluss
Con toma e interruptor
С розеткой и выключателем

Art. 2113

MIRROR - 120 x 50 Cm



Specchio
Mirror
Miroir
Spiegel
Espejo
Зеркало

--

350,00

Con presa e interruttore
With socket and switch
Avec prise et interrupteur
Mit schalteranschluss
Con toma e interruptor
С розеткой и выключателем

Art. 2114

MIRROR - 70 x 75 Cm



Specchio
Mirror
Miroir
Spiegel
Espejo
Зеркало

--

290,00

Con presa e interruttore
With socket and switch
Avec prise et interrupteur
Mit schalteranschluss
Con toma e interruptor
С розеткой и выключателем

Art. 2115

MIRROR - 95 x 75 Cm



Specchio
 Mirror
 Miroir
 Spiegel
 Espejo
 Зеркало

--

345,00

Con presa e interruttore
 With socket and switch
 Avec prise et interrupteur
 Mit schalteranschluss
 Con toma e interruptor
 С розеткой и выключателем

Art. 2116

MIRROR - 120 x 75 Cm



Specchio
 Mirror
 Miroir
 Spiegel
 Espejo
 Зеркало

--

440,00

Con presa e interruttore
 With socket and switch
 Avec prise et interrupteur
 Mit schalteranschluss
 Con toma e interruptor
 С розеткой и выключателем

Art. 2117

LED LAMP



Lampada LED
 LED lamp
 Lampe LED
 LED-leuchte
 Lámpara LED
 Светильник светодиодный

--

120,00

Art. PO101



Ordine minimo 5 m²
 Minimum order: 5 m²
 Commande minimale 5 m²
 Mindestbestellung 5 m²
 Pedido mínimo 5 m²
 Минимальный заказ 5 м²

Standard m² - 200,00

Water Resistant m² - 260,00

In fibra di vetro per zona doccia, kit montaggio compreso (primer, collante, resina protettiva)

Made of glass fiber for shower area, assembly kit is included (primer, glue, protective resin)

En fibre de verre pour l'espace douche, kit de montage compris (primer, colle, résine de protection)

Aus Glasfaser für den Duschbereich, inklusive Montagesatz (Primer, Kleber, Schutzharz)

De fibra de vidrio para zona ducha, kit de montaje incluido (primer, cola, resina protectora)

Стеклопластик для душа, включая комплект для сборки (грунтовка, клей, защитная смола)

Art. PO102

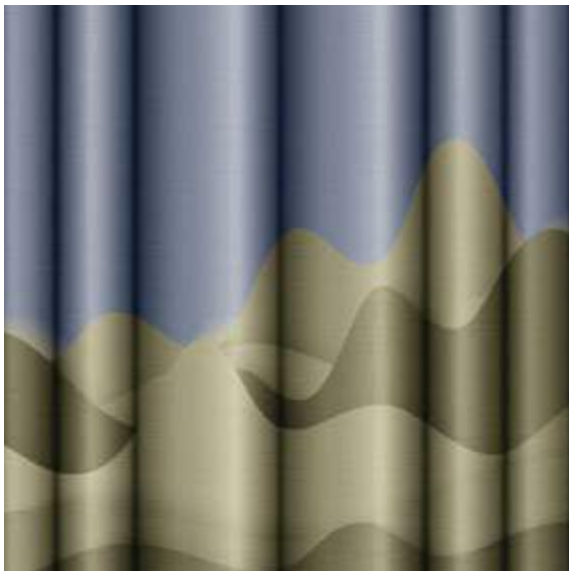

Ordine minimo 5 m²
 Minimum order: 5 m²
 Commande minimale 5 m²
 Mindestbestellung 5 m²
 Pedido mínimo 5 m²
 Минимальный заказ 5 м²

Standard m² - 200,00

Water Resistant m² - 260,00

In fibra di vetro per zona doccia, kit montaggio compreso (primer, collante, resina protettiva)

Made of glass fiber for shower area, assembly kit is included (primer, glue, protective resin)

En fibre de verre pour l'espace douche, kit de montage compris (primer, colle, résine de protection)

Aus Glasfaser für den Duschbereich, inklusive Montagesatz (Primer, Kleber, Schutzharz)

De fibra de vidrio para zona ducha, kit de montaje incluido (primer, cola, resina protectora)

Стеклопластик для душа, включая комплект для сборки (грунтовка, клей, защитная смола)

Art. PO103

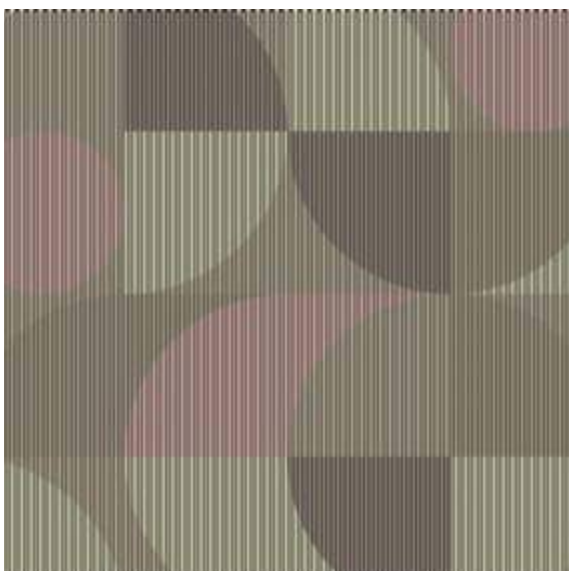

Ordine minimo 5 m²
 Minimum order: 5 m²
 Commande minimale 5 m²
 Mindestbestellung 5 m²
 Pedido mínimo 5 m²
 Минимальный заказ 5 м²

Standard m² - 200,00

Water Resistant m² - 260,00

In fibra di vetro per zona doccia, kit montaggio compreso (primer, collante, resina protettiva)

Made of glass fiber for shower area, assembly kit is included (primer, glue, protective resin)

En fibre de verre pour l'espace douche, kit de montage compris (primer, colle, résine de protection)

Aus Glasfaser für den Duschbereich, inklusive Montagesatz (Primer, Kleber, Schutzharz)

De fibra de vidrio para zona ducha, kit de montaje incluido (primer, cola, resina protectora)

Стеклопластик для душа, включая комплект для сборки (грунтовка, клей, защитная смола)

Art. PO104



Ordine minimo 5 m²
 Minimum order: 5 m²
 Commande minimale 5 m²
 Mindestbestellung 5 m²
 Pedido mínimo 5 m²
 Минимальный заказ 5 м²

Standard m² - 200,00

Water Resistant m² - 260,00

In fibra di vetro per zona doccia, kit montaggio compreso (primer, collante, resina protettiva)

Made of glass fiber for shower area, assembly kit is included (primer, glue, protective resin)

En fibre de verre pour l'espace douche, kit de montage compris (primer, colle, résine de protection)

Aus Glasfaser für den Duschbereich, inklusive Montagesatz (Primer, Kleber, Schutzharz)

De fibra de vidrio para zona ducha, kit de montaje incluido (primer, cola, resina protectora)

Стеклопластик для душа, включая комплект для сборки (грунтовка, клей, защитная смола)

Art. PO105



Ordine minimo 5 m²
 Minimum order: 5 m²
 Commande minimale 5 m²
 Mindestbestellung 5 m²
 Pedido mínimo 5 m²
 Минимальный заказ 5 м²

Standard m² - 200,00

Water Resistant m² - 260,00

In fibra di vetro per zona doccia, kit montaggio compreso (primer, collante, resina protettiva)

Made of glass fiber for shower area, assembly kit is included (primer, glue, protective resin)

En fibre de verre pour l'espace douche, kit de montage compris (primer, colle, résine de protection)

Aus Glasfaser für den Duschbereich, inklusive Montagesatz (Primer, Kleber, Schutzharz)

De fibra de vidrio para zona ducha, kit de montaje incluido (primer, cola, resina protectora)

Стеклопластик для душа, включая комплект для сборки (грунтовка, клей, защитная смола)

Art. PO106

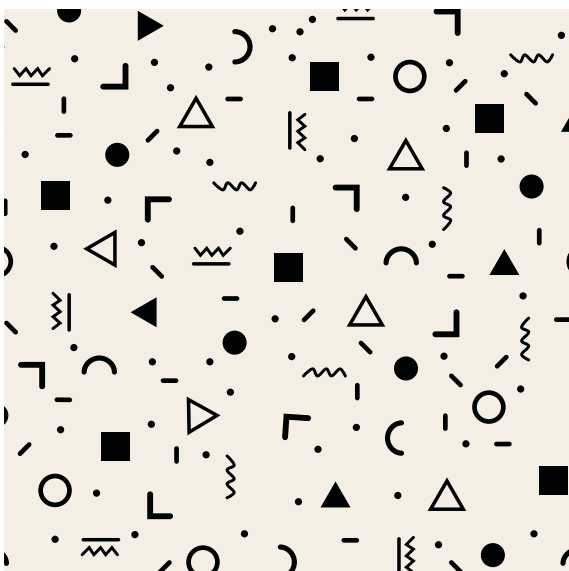

Ordine minimo 5 m²
 Minimum order: 5 m²
 Commande minimale 5 m²
 Mindestbestellung 5 m²
 Pedido mínimo 5 m²
 Минимальный заказ 5 м²

Standard m² - 200,00

Water Resistant m² - 260,00

In fibra di vetro per zona doccia, kit montaggio compreso (primer, collante, resina protettiva)

Made of glass fiber for shower area, assembly kit is included (primer, glue, protective resin)

En fibre de verre pour l'espace douche, kit de montage compris (primer, colle, résine de protection)

Aus Glasfaser für den Duschbereich, inklusive Montagesatz (Primer, Kleber, Schutzharz)

De fibra de vidrio para zona ducha, kit de montaje incluido (primer, cola, resina protectora)

Стеклопластик для душа, включая комплект для сборки (грунтовка, клей, защитная смола)

Art. 10010/C



Scarico automatico 1"1/4 click-clack, tappo grande
Automatic pop-waste 1" 1/4 click-clack, big plug
Bonde clic-clac, grand debit
Automatischer ablauf click-clack, crosser stöpsel
Valvula automática 1" 1/4 click-clack, tapón grande
Слив автоматический: клапан 1"1/4, большая пробка

CR  / NROP  + WHITE 105,00

ORS  + WHITE 145,00

CR  / NROP  + COLORS 130,00

ORS  + COLORS 175,00

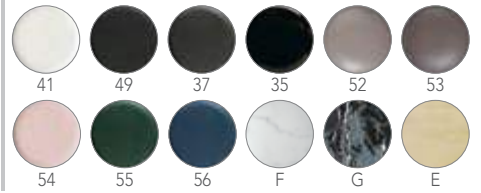

Art. 10034



Piletta lavabo da 1"1/4
con troppo pieno integrato
1"1/4 washbasin waste with overflow
Bonde lavabo de 1"1/4 avec trop-plein intégré
Waschbeckenabfluss 1"1/4 mit integriertem Überlaufschutz
Desagüe lavabo de 1"1/4 con rebosadero integrado
Донный клапан для умывальника 1"1/4 с интегрированным переливом

CR  200,00

NROP  220,00

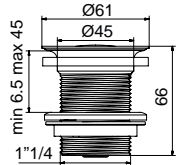

Art. 10010



Scarico automatico 1"1/4 click-clack,
tappo grande
Automatic pop-waste 1" 1/4 click-clack, big plug
Bonde clic-clac, grand debit
Automatischer ablauf click-clack, crosser stöpsel
Valvula automática 1" 1/4 click-clack, tapón grande
Слив автоматический: клапан 1"1/4, большая пробка

CR  100,00

NROP  100,00

Art. 10026



Piletta sempre aperta
Waste always open
Bonde toujours ouverte
Immer offener Auslauf
Pileta siempre abierta
Сток всегда открыт

CR  105,00

Art. 10035



Copri piletta in ceramica Art. 10010/C (ricambio)
Ceramic Cover for pop-up waste
Art. 10010/C (spare)
Cache bonde en céramique
Art. 10010/C (pièce détachée)
Keramische abdeckung für ablauf click-clack
Art. 10010/C (ersatzteil)
Tapa de desagüe de cerámica
Art. 10010/C (repuesto)
Донный клапан из керамики
Art. 10010/C (запасной)

WHITE 40,00

COLORS 55,00

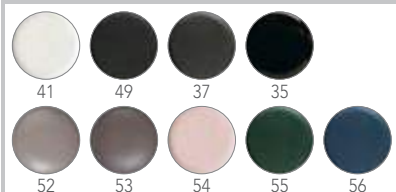

Art. 10032
COMPACT TRAP

Sifone compatto in ottone
 Brass compact trap
 Siphon compact en laiton
 Kompakter Siphon aus Messing
 Sifón compacto de latón
 Компактный сифон из латуни

CR 	290,00
NROP 	290,00

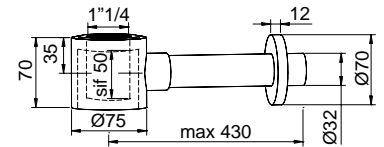
Art. 10007

Sifone quadro in ottone 1" 1/4 cromato
 Cp Brass square trap 1" 1/4 chromed
 Syphon carré en laiton chromé
 Siphon aus verchromtem messing, viereckig
 Sifón cuadrado de latón 1" 1/4 cromado
 Сифон квадратного сечения 1"1/4 из хромированной латуни

CR 	135,00
--	--------

Art. 10008

Sifone tondo in ottone 1" 1/4 cromato
 Cp Brass round trap 1" 1/4 chromed
 Syphon rond en laiton chromé
 Siphon aus verchromtem messing, rund
 Sifón redondo de latón 1" 1/4 cromado
 Сифон круглого сечения 1"1/4 из хромированной латуни

CR 	115,00
NROP 	170,00
ORS 	290,00

Art. 10009

Sifone tondo in ottone ribassato 1" 1/4 cromato
 Cp Brass round trap, shorted 1" 1/4 chromed
 Syphon petit culot laiton chromé
 Siphon aus verchromtem messing, abgeflacht
 Sifón redondo de latón rebajado 1" 1/4 cromado
 Сифон круглого сечения 1"1/4 укороченный, из хромированной латуни

CR 	115,00
NROP 	170,00
ORS 	290,00

Art. 10019

Sifone in ottone da 1" 1/4 per bidet
 Brass trap, 1" 1/4 chromed for bidet
 Syphon petit chromé 1" 1/4 pour bidet
 Siphon aus verchromtem 1" 1/4 fur bidet
 Sifón de latón de 1" 1/4 para bidé
 Сифон латунный 1"1/4 для биде

CR 	135,00
--	--------

Art. 10012

CR 

30,00



Distanziatore in ABS Cromato
ABS spacer Chromed
Entretoise en ABS chromé
Distanzstück aus verchromtem ABS
Separador de abs cromado
Распорная шайба из хромированного пластика АБС

Art. 10004/A

CR 

55,00

Cerniere cromate complete di kit fissaggio
Chromed kit for seat cover
Charnières avec kit de montage
Scharniere komplett mit montagebausatz
Bisagras cromadas con kit de fijación
Хромированные шарниры в комплекте с крепежом

Al momento dell'ordine indicare l'articolo del coprivater
Indicate the WC cover article on making the order
A la commande, indiquer la référence de la planche WC
Bei Bestellung die Artikelnummer des WC-Deckels angeben
Al hacer el pedido indicar el artículo de la tapa de inodoro
В момент заказа укажите артикль крышки унитаза

Art. 10004/B

CR 

100,00

Set cerniere rallentate di ricambio per coprivater complete di kit fissaggio
Soft Closed System For Seat Cover
Charnieres Avec Frein De Chute
Mit Sanft Abgebremsten Scharnieren
Juego de bisagras ralentizadas de repuesto para tapa de inodoro completas de kit de fijación
Комплект запасных замедленных петель для крышки унитаза с крепежным комплектом

Al momento dell'ordine indicare l'articolo del coprivater
Indicate the WC cover article on making the order
A la commande, indiquer la référence de la planche WC
Bei Bestellung die Artikelnummer des WC-Deckels angeben
Al hacer el pedido indicar el artículo de la tapa de inodoro
В момент заказа укажите артикль крышки унитаза

Art. 10030

60,00

Cartucce di ricambio per copri water soft closed
Spare cylindrical parts for soft closed wc cover
Amortisseurs de rechange pour abattant à descente retenue
Ersatzkartuschen für toilettensitz mit absenkautomatik
Piezas cilíndricas de repuesto para cubre tapa inodoro soft closed
Сменные детали микролифта для крышки унитаза

Al momento dell'ordine indicare l'articolo del coprivater
Indicate the WC cover article on making the order
A la commande, indiquer la référence de la planche WC
Bei Bestellung die Artikelnummer des WC-Deckels angeben
Al hacer el pedido indicar el artículo de la tapa de inodoro
В момент заказа укажите артикль крышки унитаза

Art. 10047

15,00

Kit paracolpi per copri water
Bumpers for toilet seat cover
Set tampons pour abattant
Puffern für wc-deckel
Kit paragolpes para cubre inodoro
Набор пластиковых опор для туалетного сидения

Al momento dell'ordine indicare l'articolo del coprivater
Indicate the WC cover article on making the order
A la commande, indiquer la référence de la planche WC
Bei Bestellung die Artikelnummer des WC-Deckels angeben
Al hacer el pedido indicar el artículo de la tapa de inodoro
В момент заказа укажите артикль крышки унитаза

Art. 10005

70,00



Staffe di montaggio Wc e bidet
Fixing attachments for Wc and bidet
Supports de montage pour cuvette et bidets suspendus
Montagebügel Für Hänge-wc und bidet
Soportes de montaje inodoro y bidé
Монтажные кронштейны для унитаза и биде

Art. 10006

25,00

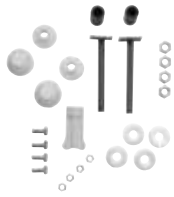

Viti per fissaggio Wc e bidet
Screw for Wc and bidet
Vis de fixation cuvettes et bidets suspendus
Befestigungsschrauben Für Hänge-wc und bidet
Tornillos para fijación inodoro y bidé
Винты крепления унитаза и бидеа

Art. 10050/A

STANDARD

20,00

Art. 10050/B

WB9 2.0 CLICK SYSTEM

25,00

Art. 10050/C

STANDARD "MOAI"

20,00



Art. 10050/A



Art. 10050/B



Art. 10050/C

Fissaggio Rapido per Sanitari
Quick fixing kit for sanitary fittings
Fixation rapide pour sanitaires
Schnellverbindung für Sanitäranlagen
Fijación rápida para sanitarios
Набор быстрого монтажа для сантехники

Art. 10014

40,00



Curva tecnica per Wc
Technical plastic curve for wc
Pipe coudée pour cuvette
wc-anschlussbogen"
Curva técnica para inodoro
Колено сливное для унитаза

Art. 10014/A

40,00



Curva tecnica per Wc Art. 5522/CL - 60 / 160 mm
Technical plastic curve for wc Art. 5522/CL - 60 / 160 mm
Pipe coudée pour cuvette Art. 5522/CL - 60 / 160 mm
wc-anschlussbogen Art. 5522/CL - 60 / 160 mm
Curva técnica para inodoro Art. 5522/CL - 60 / 160 mm
Колено сливное для унитаза арт. 5522/CL - 60 / 160 mm

Art. 10014/B

40,00

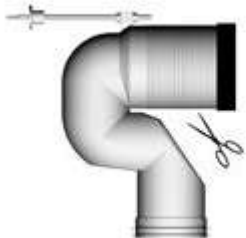

Curva tecnica per Wc Art. 5522/CL - 170 / 215 mm
Technical plastic curve for wc Art. 5522/CL - 170 / 215 mm
Pipe coudée pour cuvette Art. 5522/CL - 170 / 215 mm
wc-anschlussbogen Art. 5522/CL - 170 / 210 mm
Curva técnica para inodoro Art. 5522/CL - 170 / 215 mm
Колено сливное для унитаза арт. 5522/CL - 170 / 215 mm

Art. 10028

17,00

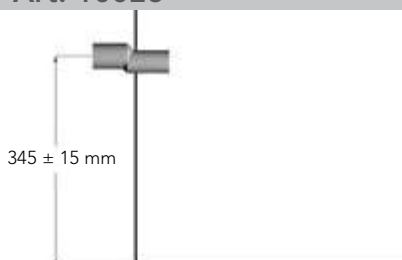

Eccentrico - 345 ± 15 mm
Eccentric - 345 ± 15 mm
Excentrique - 345 ± 15 mm
Exzentrisch - 345 ± 15 mm
Excéntrico - 345 ± 15 mm
Эксцентрик - 345 ± 15 mm

Art. 10022

115,00



Sistema di scarico per Art. 5527 / Art. 5141
Flushing system for Art. 5527 / Art. 5141
Système de chasse pour Art. 5527 / Art. 5141
Ablaufsystem Für Art. 5527 / Art. 5141
Sistema De Descarga Para Art. 5527 / Art. 5141
Система слива для арт. 5527 / арт. 5141



Entrata acqua sotto a destra da 1/2"
Right hand bottom 1/2" inch inlet
Entrée eau en bas à droite 1/2 pouce
Wassereinlauf unten rechts mit 1/2 Zoll
Entrada de agua inferior derecha de 1/2"
Вход воды снизу справа, 1/2"

Art. 10016

252,00



Sistema di scarico Geberit per Art. 8404 / Art. 2013
Flushing system Geberit for Art. 8404 / Art. 2013
Système d'évacuation geberit pour Art. 8404 / Art. 2013
Geberit ablaufsystem Für Art. 8404 / Art. 2013
Sistema De Descarga Geberit Para Art. 8404 / Art. 2013
Система слива Geberit для арт. 8404 / арт. 2013



Entrata acqua sotto a destra da 1/2"
Right hand bottom 1/2" inch inlet
Entrée eau en bas à droite 1/2 pouce
Wassereinlauf unten rechts mit 1/2 Zoll
Entrada de agua inferior derecha de 1/2"
Вход воды снизу справа, 1/2"

Art. 10048

79,00

Staffe di montaggio per mobili
Assembly brackets for furniture
Supports de montage pour meubles
Montagebügel für Möbel
Soportes de montaje para muebles
Монтажные кронштейны для мебели

Art. 10029

40,00



Sifone per lavabo salvaspazio
Space saving sink siphon
Siphon pour lavabo dimension reduite
Platzsparender Spülensiphon
Sifón de fregadero que ahorra espacio
Сифон для экономии пространства

NOTA BENE

1) Il sistema di scarico piletta deve sempre essere ancorato al lavabo pertanto il foro consigliato da praticare sul top dove vengono appoggiati i lavabi deve avere un diametro necessario a consentire tale operazione. Per i nostri prodotti si prega di ricavare le dovute dimensioni dei fori da praticare sui top dalla sezione Caratteristiche tecniche del catalogo generale.

2) Il diametro del foro consigliato da praticare sul top per il passaggio delle connessioni dell'acqua al rubinetto deve essere non inferiore a 40 mm di diametro. Si prega di controllare prima di praticare il foro anche la scheda tecnica del rubinetto che viene utilizzato.

*** Specifica Certificazioni e conformità alla norma UNI EN 997 - 14528 riguardante lo scarico dei WC e bidet relativa marchiatura CE.**
La documentazione completa è disponibile a richiesta presso i nostri uffici.

NOTE

1) The plughole drainage system must always be fixed to the washbasin; it is therefore recommended that the holes made in the tops on which the washbasins are mounted have a diameter large enough to accommodate this. As far as our products are concerned, please refer to the Technical Characteristics section of the General Catalogue to obtain details of the specific measurements necessary for the holes made in the tops.

2) The minimum recommended diameter of the hole to be made in the top for the passage of the water connections to the tap is 40 mm. Please make sure you also check the technical specification of the tap used before making the hole.

*** Specification outlining certifications and conformity with standard UNI EN 997 - 14528 (relating to WC waste pipes and bidet) and corresponding CE branding.**

The complete documentation is available from our offices on request.

REMARQUE

1) La bonde d'écoulement doit toujours être fixée au lavabo. Pour effectuer cette opération, il est donc recommandé de découper sur le plan une ouverture du diamètre prévu pour le lavabo. À la section Caractéristiques techniques de notre catalogue général, vous pourrez trouver les dimensions requises pour les ouvertures à réaliser sur les plans.

2) Il est conseillé de percer un trou pour le passage des raccords de l'arrivée d'eau au robinet d'un diamètre d'au moins 40 mm. Veuillez à vérifier les cotes de l'orifice précisées sur la fiche technique du robinet utilisé

*** Caractéristiques techniques et certificat de conformité (UNI EN 997 - 14528) pour la décharge des WC et bidet et label CE.**

La documentation complète est disponible sur demande en nos bureaux.

HINWEIS

1) Das Abflusssystem muss immer am Waschbecken befestigt werden, daher sollte die Bohrung im Top, auf dem die Waschbecken gestellt werden, einen ausreichenden Durchmesser haben, um den Anschluss auszuführen. Die notwendigen Durchmesser der Bohrungen im Top für unsere Produkte entnehmen Sie bitte dem Abschnitt Technische Eigenschaften in unserem Katalog.

2) Die im Top für die Durchleitung der Wasseranschlüsse benötigte Bohrung darf nicht weniger als 40 mm Durchmesser aufweisen. Bitte prüfen Sie, bevor sie das Loch bohren, auch das Datenblatt des Wasserhahns, der installiert wird.

*** Zertifizierung und Konformität mit der Norm UNI EN 997 - 14528 bezüglich der WC-Abflüsse und bidet und entsprechende CE-Kennzeichnung.**

Die komplette Dokumentation kann in unseren Büros angefordert werden.

ADVERTENCIA

1) El sistema de desagüe del sumidero debe estar siempre anclado al lavabo; por tanto, se aconseja efectuar en la encimera donde se apoyarán los lavabos un orificio con el diámetro suficiente para que pueda efectuarse esa operación. En el caso de nuestros productos, las medidas de los orificios que se han de practicar se encuentran en el apartado "Características técnicas" del Catálogo general.

2) En la encimera, para pasar las conexiones de agua al grifo, se practicará un orificio de diámetro no inferior a 40 mm. Antes de perforar, consúltese la ficha técnica del grifo que se ha de utilizar.

*** Especificación de certificaciones y conformidad con la norma UNI EN 997 relativa a la descarga del inodoro y a la correspondiente marca CE**

La documentación completa está a disposición en nuestras oficinas.

ВАЖНАЯ ИНФОРМАЦИЯ

1) Система слива с пробкой должна всегда быть закреплена на раковине умывальника, в связи с чем рекомендуется, чтобы отверстие в столешнице, на которую должна опираться раковина умывальника, имело достаточно большой диаметр, обеспечивающий выполнение этой операции. Что касается нашей продукции, см. раздел «Технические характеристики» основного каталога, где приведены соответствующие размеры отверстий, выполняемых в столешнице.

2) Рекомендуемый размер отверстия в столешнице для прохождения соединительных шлангов подачи воды в кран должен составлять не менее 40 мм в диаметре. Прежде чем делать отверстие, рекомендуется свериться с техническими данными крана, который будет использоваться.

*** Технические условия на сертификацию и соответствие требованиям UNI EN 997–14528 в отношении слива унитазов и биде по маркировке CE.**

Полная документация доступна по запросу в офисах нашей компании.

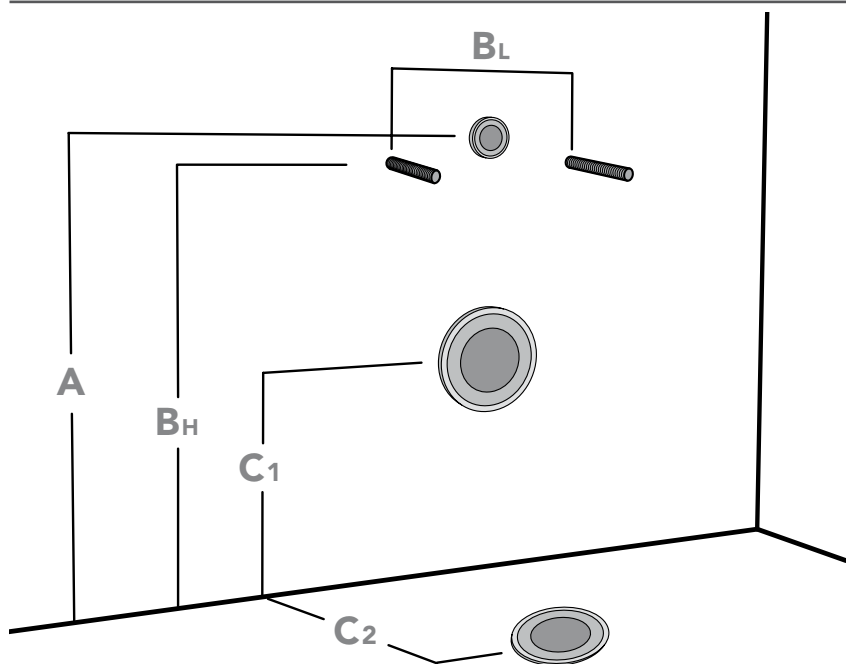

- A** Ingresso acqua scarico WC
 Wc flush water inlet
 Entrée eau décharge wc
 Wasserzufluss spülung wc
 Entrada agua desagüe wc
 Подача воды слив унитаза
- B** Grani di fissaggio sospesi
 Suspended fixing screws
 Boulons de fixation suspendus
 Gewindestifte zur aufhängung
 Tornillos de fijación suspendidos
 Винты фиксирующие подвесные
- C1** Scarico WC a parete
 Wc wall flushing system
 Décharge wc mur
 Abfluss wand-wc
 Desagüe wc de pared
 Слив унитаза в стену
- C2** Scarico WC a pavimento
 Wc floor flushing system
 Décharge wc sol
 Abfluss boden-wc
 Desagüe wc de pavimento
 Слив унитаза в полу

SERIES	Art.	A	B _H	B _L	C ₁	C ₂
MOON	5520	370	335	180	235	
	5520/CL	370	335	180	235	
	5524/CL	370	335	180	235	
	5522/CL	345 ± 15			175	60/210
	5526/CL				185	210
TEOREMA 2.0	5126/TW	355	325	180	220	
	5126/CL	355	325	180	220	
	5138/CL	350 ± 15			175	60/210
	5140/CL				175	210
GLAM	5201/TW	370	335	180	235	
BUCKET	8812	355	325	180	220	
	8812/CL	355	325	180	220	
	8815	285	250	180	150	
PLANET	8105	400	360	180	270	
	8105/CL	400	360	180	270	
	8401	375			185	110
MOAI	8604	380	345	180	245	
	8606	365			170	110
TEOREMA	8701	360	330	180	220	
CASTELLANA	5306	345			170	120
	5308				175	130/250
BUTTERFLY	4006	365	330	180	230	
	4008	365			180	110

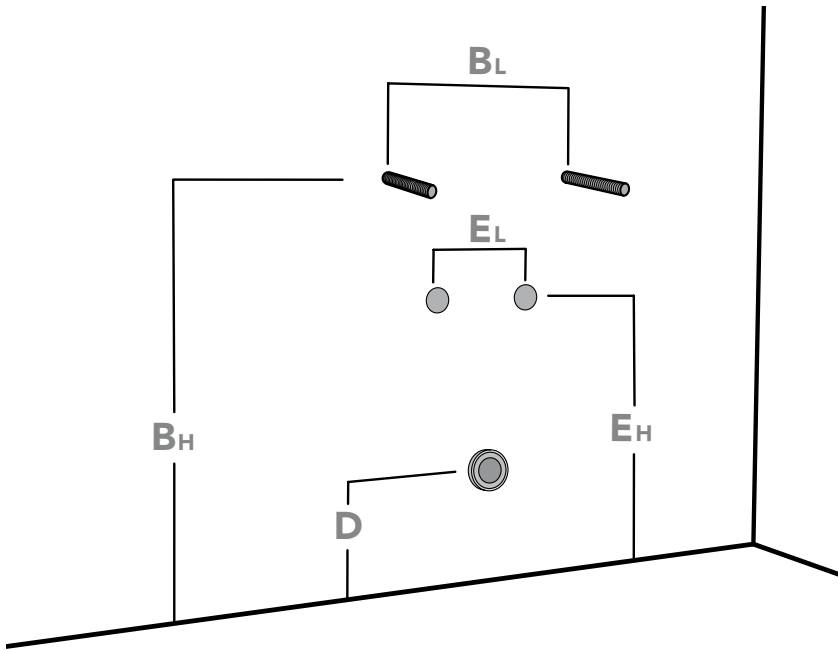

- B** Grani di fissaggio sospesi
 Suspended fixing screws
 Boulons de fixation suspendus
 Gewindestifte zur aufhängung
 Tornillos de fijación suspendidos
 Винты фиксирующие подвесные
- D** Scarico bidet con sifone Art. 10019
 Bidet outlet with trap Art. 10019
 Décharge bidet avec siphon Art. 10019
 Abfluss bidet mit siphon Art. 10019
 Desagüe bidé con sifón Art. 10019
 Слив биде с сифоном арт. 10019
- E** Ingresso acqua bidet
 Bidet water inlet
 Entrée eau bidet
 Wasserzufluss bidet
 Entrada agua bidé
 Подача воды в биде

SERIES	Art.	B _H	B _L	D	E _H	E _L
MOON	5521	335	180	130	250	130
	5525	335	180	130	250	120
	5523			130	250	120
TEOREMA 2.0	5127	325	180	130	220	120
	5139			130	250	120
GLAM	5201	335	180	130	250	130
BUCKET	8813	325	180	130	200	100
PLANET	8106	306	180	100	225	110
	8402			90	240	130
MOAI	8605	305	180	130	210	120
	8607			130	300	110
TEOREMA	8702	330	180	130	220	60
CASTELLANA	5307			130	220	120
BUTTERFLY	4007	330	180		220	120
	4009				220	120

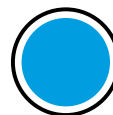
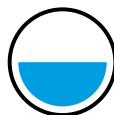

Art.	DESCRIPTION	3lt	4lt	4,5lt	5lt	6lt
5520	MOON WALL-MOUNTED WC	✓	✓	✓	✓	✓
5520/CL	MOON WALL-MOUNTED WC Clean Flush WC	✓	✓	✓	✓	✓
5522	MOON FLOOR-MOUNTED WC	✓	✓	✓	✓	✓
5522/CL	MOON FLOOR-MOUNTED WC Clean Flush WC	✓	✓	✓	✓	✓
5526/CL	MOON WC MONOBLOCK Clean Flush WC	✓	✓	✓	✓	✓
5524/CL	MOON WALL-MOUNTED WC Clean Flush WC	✓	✓	✓	✓	✓
5521	MOON WALL-MOUNTED BIDET	CL 25				
5523	MOON FLOOR-MOUNTED BIDET	CL 25				
5525	MOON WALL-MOUNTED BIDET	CL 25				
5126/TW	TEOREMA 2.0 WALL-MOUNTED Twist WC	✓	✓	✓	✓	✓
5126/CL	TEOREMA 2.0 WALL-MOUNTED Clean Flush WC	✓	✓	✓	✓	✓
5138/CL	TEOREMA 2.0 FLOOR-MOUNTED WC Clean Flush WC	✓	✓	✓	✓	✓
5140/CL	TEOREMA 2.0 WC MONOBLOCK Clean Flush WC	✓	✓	✓	✓	✓
5127	TEOREMA 2.0 WALL-MOUNTED BIDET	CL 25				
5139	TEOREMA 2.0 FLOOR-MOUNTED BIDET	CL 25				
5201/TW	GLAM WALL-MOUNTED Twist WC	✓	✓	✓	✓	✓
5202	GLAM WALL-MOUNTED BIDET	CL 25				
8812	BUCKET WALL-MOUNTED WC	✓	✓	✓	✓	✓
8812/CL	BUCKET WALL-MOUNTED WC Clean Flush WC	✓	✓	✓	✓	✓
8815	BUCKET WALL-MOUNTED WC KIDS	✓	✗	✓	✓	✓
8813	BUCKET WALL-MOUNTED BIDET	CL 25				
8105	PLANET WALL-MOUNTED WC	✓	✓	✓	✓	✓
8105/CL	PLANET WALL-MOUNTED WC Clean Flush WC	✓	✓	✓	✓	✓
8401	PLANET FLOOR-MOUNTED WC	✓	✓	✓	✓	✓
8106	PLANET WALL-MOUNTED BIDET	CL 25				
8403	PLANET FLOOR-MOUNTED BIDET	CL 25				
8604	MOAI WALL-MOUNTED WC	✓	✓	✓	✓	✓
8606	MOAI FLOOR-MOUNTED WC	✓	✓	✓	✓	✓
8605	MOAI WALL-MOUNTED BIDET	CL 25				
8607	MOAI FLOOR-MOUNTED BIDET	CL 25				
8701	TEOREMA WALL-MOUNTED WC	✓	✓	✓	✓	✓
8702	TEOREMA WALL-MOUNTED BIDET	CL 25				

ECO WATER SAVING PLUS

La continua ricerca e lo sviluppo di nuovi prodotti con innovativi sistemi di scarico ha consentito la creazione di **ECO WATER SAVING PLUS**, grazie al quale i nostri Wc scaricano utilizzando **solo 2/4lt d'acqua**.

Continual research and development into new products with innovative flush systems has led to creation of **ECO WATER SAVING plus**, thanks to which our WCs **only use 2/4l water** for flushing.

La recherche continue et le développement de nouveaux produits dotés de systèmes d'évacuation novateurs ont permis la création d'**ECO WATER SAVING**, grâce auquel une chasse **n'utilise que 2 à 4 litres d'eau**.

Die konstante Erforschung und Entwicklung neuer Produkte mit innovativen Abflusssystemen ermöglichte die Kreation des Systems **ECO WATER SAVING Plus**, dank dem unsere WCs beim Spülen **nur 2 oder 4 Liter Wasser** verbrauchen.

La continua actividad de investigación y desarrollo de nuevos productos con innovadores sistemas de desagüe ha permitido la creación de **ECO WATER SAVING plus**, con el cual nuestros WC se descargan utilizando **sólo 2-4 litros de agua**.

Непрерывающиеся исследования и разработки новых изделий с применением инновационных систем слива открыли возможности для создания такой системы, как **ECO WATER SAVING plus**, благодаря использованию которой в наших унитазах при сливе используется только **2–4 л воды**.

Art.	DESCRIPTION	Geberit *	Tece	Oli *	Geberit **	Oli **	Grohe	Valsir
5520	MOON WALL-MOUNTED WC	2,5 lt		2,5 lt			2 lt	2 lt
5520/CL	MOON WALL-MOUNTED WC Clean Flush WC	2,5 lt	2,5 lt	2,5 lt			3 lt	
5522	MOON FLOOR-MOUNTED WC	2,8 lt	2,8 lt	2,8 lt				2 lt
5522/CL	MOON FLOOR-MOUNTED WC Clean Flush WC	2,8 lt	2,8 lt	2,8 lt				2 lt
5526/CL	MOON WC MONOBLOCK Clean Flush WC				3 lt	4 lt		
5524/CL	MOON WALL-MOUNTED WC Clean Flush WC	2,5 lt	2,5 lt	2,5 lt			3 lt	
5126/TW	TEOREMA 2.0 WALL-MOUNTED Twist WC	2,5 lt	2,5 lt				2,5 lt	2,5 lt
5126/CL	TEOREMA 2.0 WALL-MOUNTED Clean Flush WC	3 lt	3 lt				3 lt	3 lt
5138/CL	TEOREMA 2.0 FLOOR-MOUNTED WC Clean Flush WC	3 lt	3 lt				3 lt	3 lt
5140/CL	TEOREMA 2.0 WC MONOBLOCK Clean Flush WC				3 lt	4 lt		
5201/TW	GLAM WALL-MOUNTED Twist WC	2,5 lt	2,5 lt				2,5 lt	2,5 lt
8812	BUCKET WALL-MOUNTED WC	3 lt		3 lt			2 lt	2 lt
8812/CL	BUCKET WALL-MOUNTED WC Clean Flush WC	2,5 lt	2,5 lt	2,5 lt			2 lt	2 lt
8105	PLANET WALL-MOUNTED WC	3 lt		3 lt			2 lt	2 lt
8105/CL	PLANET WALL-MOUNTED WC Clean Flush WC	3 lt	3 lt	3 lt			2 lt	2 lt
8401	PLANET FLOOR-MOUNTED WC	3 lt		3 lt			2 lt	2 lt
8701	TEOREMA WALL-MOUNTED WC	2,5 lt	2,5 lt				2 lt	2 lt

Geberit * = Art. 111.907.00.5 Duofix Sigma 12 / Art. 111.907.00.1 Duofix Sigma 8 - UNI EN 997 CL2

Tece = Art. 9.370.007 Tece Box - UNI EN 997 CL2

Oli * = Art. OL0601881 OLI74 PLUS - UNI EN 997 CL2

Geberit ** = Art. 273.401.21.1 DUAL BC 3/8 - UNI EN 997 CL2

Oli ** = Art. OL0501124 ATLAS/AZOR ATT.BASSO 3/8 - UNI EN 997 CL2

Grohe = Art. 38661000 - UNI EN 997 CL2

Valsir = Art. T-VSO858002 - UNI EN 997 CL2

CLEAN FLUSH WC®

La nuova generazione di WC senza brida Scarabeo stabilisce nuovi standard d'igiene grazie all'innovativo Clean Flush WC®. Per una pulizia completa con la massima semplicità. Rispetto ai WC a brida chiusa, il flusso d'acqua dinamico e potente che con assenza della brida, la cavità dove si deposita lo sporco, il calcare e dove proliferano i batteri, descrive un cerchio orizzontale prima che l'acqua scarichi in verticale e sciacqua così tutta la superficie interna del vaso.

Ancora una volta Scarabeo coniuga con perfetta armonia design e tecnologia.

The latest generation of Scarabeo WC without a flange sets new hygiene standards thanks to the innovative Clean Flush WC®. Total cleaning which is as easy as it could be. Compared with a closed flange WC, the dynamic and powerful flow of water, which, minus the flange, the cavity where dirt accumulates and where bacteria proliferate, forms a horizontal circle before the water is flushed vertically and thus rinses the entire inside surface of the bowl.

Scarabeo has once again combined design and technology in perfect harmony.

La nouvelle génération de WC sans bride Scarabeo donne le ton en matière d'hygiène grâce à son WC Clean Flush® innovant. Pour un nettoyage complet en toute simplicité. A la différence des WC à bride fermée, le débit d'eau est plus puissant et plus dynamique. Il décrit un cercle horizontal avant que l'eau s'écoule de haut en bas. L'absence de rebord propice à l'accumulation de saleté, de calcaire et à la prolifération des bactéries autorise un nettoyage de toute la surface de la cuvette.

Une fois de plus, Scarabeo allie design et technologie dans une harmonie parfaite.

Die jüngste Generation des WCs ohne Spülrand von Scarabeo setzt mit dem innovativen Clean Flush WC® neue Hygienestandards. Die komplette Reinigung ist ganz einfach. Im Vergleich zu WCs mit geschlossenem Spülrand haben wir hier einen dynamischen und kräftigen Wasserstrahl. Da kein Rand mehr vorhanden ist, können sich auch keine Bakterien, Verschmutzungen und Kalk absetzen. Der Wasserfluss beschreibt zunächst einen horizontalen Kreis und fließt dann vertikal nach unten ab. Auf diese Weise wird das gesamte Becken gründlich gereinigt.

Wieder ist es Scarabeo gelungen, Design und Technologie harmonisch miteinander zu verbinden.

La nueva generación de WC sin brida Scarabeo establece nuevos estándares de higiene gracias al innovador Clean Flush WC®. Para una limpieza completa con la máxima sencillez. A diferencia de los WC con brida cerrada, el flujo de agua, dinámico y potente, en ausencia de brida -cavidad donde se deposita la suciedad y la cal y donde proliferan las bacterias-, describe un círculo horizontal antes de que el agua se descargue verticalmente, y enjuaga de esta manera toda la superficie interna del WC.

Una vez más, Scarabeo armoniza el diseño con la tecnología de manera perfecta.

Новое поколение безободковых унитазов Scarabeo устанавливает новые стандарты гигиены благодаря инновационному унитазу Clean Flush WC®. Полная очистка с максимальной простотой. Наличие в унитазе закрытого обода создает условия для накопления под ним известкового налета и грязи, а также размножения бактерий. При отсутствии же обода динамичный и мощный поток воды описывает горизонтальный круг, прежде чем вода стекает вертикально и таким образом промывает всю внутреннюю поверхность чаши унитаза.

В очередной раз Scarabeo предлагает идеальное сочетание дизайна и технологий.



TWIST®

Il sistema TWIST prevede un bordo contenitivo del vaso con un design tale da permettere una riduzione al minimo di qualsiasi fuoriuscita d'acqua. Lo scarico, progettato per consentire un risparmio idrico ancor più performante rispetto ai già esistenti Clean Flush adottati da Scarabeo, è realizzato con un nuovo sistema che limita al massimo il rumore favorendo un alto livello di silenziosità.

The TWIST system features a containing rim of the bowl that is designed to minimize any water spillage. The new drain can save more water than the existing Clean Flush used by Scarabeo and the new system significantly reduces the noise for a higher level of comfort.









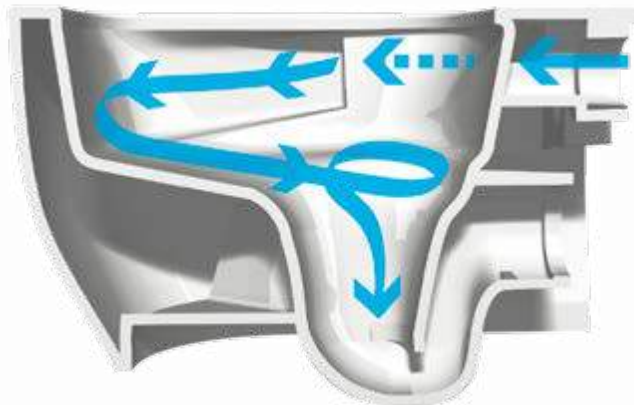

Le système TWIST comprend une bordure de cuve telle qu'elle limite au minimum toute sortie d'eau. La décharge a été conçue pour une économie d'eau supérieure aux systèmes Clean Flush adoptés par Scarabeo. Elle a été réalisée avec un nouveau système limitant le bruit au minimum.















Beim TWIST-System ist der Spülrand des Beckens so geformt, dass ein Herausspritzen von Wasser nahezu ausgeschlossen werden kann. Die Spülung, die im Vergleich zu der von Scarabeo bereits eingesetzten Clean-Flush-Technologie noch wassersparender konzipiert wurde, ist mit einem neuen System ausgestattet, das die Geräusentwicklung weitestgehend begrenzt und dadurch extrem geräuscharm ist.













El sistema TWIST presenta un borde de contención con un diseño que reduce al mínimo las salpicaduras de agua fuera del WC. La descarga, diseñada para permitir un ahorro de agua superior al de las Clean Flush existentes adoptadas por Scarabeo, está realizada con un nuevo sistema que limita todo lo posible el ruido, favoreciendo el funcionamiento más silencioso.

Продуманный дизайн с системой TWIST и сдерживающим бортом позволяет свести к минимуму разбрызгивание воды из чаши унитаза. Слив обеспечивает экономию воды – еще более эффективную, чем в системах Clean Flush других моделей Scarabeo. Использование новой системы максимально ограничивает шум, что способствует высокому уровню тишины.



DecorLAB	Art.	POIS					FULL POIS				
		 SEV	 SER	 SEM	 SENT	 SENR	 SFLV	 SFLR	 SFLM	 SFLNT	 SFLNR
Moon	5520CL										
	5521										
	5522CL										
	5523										
	5501	✓	✓	✓	✓	✓				✓	
	5504	✓	✓	✓	✓	✓				✓	
	5507	✓	✓	✓	✓	✓				✓	
	5511	✓	✓	✓	✓	✓				✓	
	5512	✓	✓	✓	✓	✓				✓	
Teorema 2.0	5101	✓	✓	✓	✓	✓					
	5102	✓	✓	✓	✓	✓					
	5129	✓	✓	✓	✓	✓					
	5111	✓	✓	✓	✓	✓					
	5112										
	5104	✓	✓	✓	✓	✓					
	5105	✓	✓	✓	✓	✓					
	5110	✓	✓	✓	✓	✓					
	5114	✓	✓	✓	✓	✓					
	5117	✓	✓	✓	✓	✓					
	5115	✓	✓	✓	✓	✓					
	5118	✓	✓	✓	✓	✓					
	5123	✓	✓	✓	✓	✓					
	5108	✓	✓	✓	✓	✓					
	5109	✓	✓	✓	✓	✓					
	5130	✓	✓	✓	✓	✓					
	5131	✓	✓	✓	✓	✓					
5132	✓	✓	✓	✓	✓						
Glam	1809	✓	✓	✓	✓	✓				✓	
	1808	✓	✓	✓	✓	✓				✓	
	1807	✓	✓	✓	✓	✓				✓	
	1806	✓	✓	✓	✓	✓				✓	
	1804										
	1805										
	1811	✓	✓	✓	✓	✓					
Bucket	8801	✓	✓	✓	✓	✓					
	8802	✓	✓	✓	✓	✓					
	8803	✓	✓	✓	✓	✓					
	8804	✓	✓	✓	✓	✓					
	8808	✓	✓	✓	✓	✓					
	8807	✓	✓	✓	✓	✓					
	8811	✓	✓	✓	✓	✓					
	8810	✓	✓	✓	✓	✓					
8809	✓	✓	✓	✓	✓						
Soft	1501	✓	✓	✓	✓	✓	✓	✓	✓	✓	✓
	1502	✓	✓	✓	✓	✓	✓	✓	✓	✓	✓
	1503	✓	✓	✓	✓	✓	✓	✓	✓	✓	✓
Hung	1511	✓	✓	✓	✓	✓	✓	✓	✓	✓	✓
	1512	✓	✓	✓	✓	✓	✓	✓	✓	✓	✓
	1513	✓	✓	✓	✓	✓	✓	✓	✓	✓	✓
Cube	1521	✓	✓	✓	✓	✓	✓	✓	✓	✓	✓
	1522	✓	✓	✓	✓	✓	✓	✓	✓	✓	✓
	1523	✓	✓	✓	✓	✓	✓	✓	✓	✓	✓

LINE					POIS STRIP					LINE STRIP				
 REV	 RER	 REM	 RENT	 RENR	 FSV	 FSR	 FSM	 FSNT	 FSNR	 RRV	 RRR	 RRM	 RRNT	 RRNR
										<input checked="" type="checkbox"/>	<input checked="" type="checkbox"/>	<input checked="" type="checkbox"/>	<input checked="" type="checkbox"/>	<input checked="" type="checkbox"/>
										<input checked="" type="checkbox"/>	<input checked="" type="checkbox"/>	<input checked="" type="checkbox"/>	<input checked="" type="checkbox"/>	<input checked="" type="checkbox"/>
										<input checked="" type="checkbox"/>	<input checked="" type="checkbox"/>	<input checked="" type="checkbox"/>	<input checked="" type="checkbox"/>	<input checked="" type="checkbox"/>
										<input checked="" type="checkbox"/>	<input checked="" type="checkbox"/>	<input checked="" type="checkbox"/>	<input checked="" type="checkbox"/>	<input checked="" type="checkbox"/>
<input checked="" type="checkbox"/>	<input checked="" type="checkbox"/>	<input checked="" type="checkbox"/>	<input checked="" type="checkbox"/>	<input checked="" type="checkbox"/>										
<input checked="" type="checkbox"/>	<input checked="" type="checkbox"/>	<input checked="" type="checkbox"/>	<input checked="" type="checkbox"/>	<input checked="" type="checkbox"/>										
<input checked="" type="checkbox"/>	<input checked="" type="checkbox"/>	<input checked="" type="checkbox"/>	<input checked="" type="checkbox"/>	<input checked="" type="checkbox"/>										
<input checked="" type="checkbox"/>	<input checked="" type="checkbox"/>	<input checked="" type="checkbox"/>	<input checked="" type="checkbox"/>	<input checked="" type="checkbox"/>										
<input checked="" type="checkbox"/>	<input checked="" type="checkbox"/>	<input checked="" type="checkbox"/>	<input checked="" type="checkbox"/>	<input checked="" type="checkbox"/>										
<input checked="" type="checkbox"/>	<input checked="" type="checkbox"/>	<input checked="" type="checkbox"/>	<input checked="" type="checkbox"/>	<input checked="" type="checkbox"/>										
<input checked="" type="checkbox"/>	<input checked="" type="checkbox"/>	<input checked="" type="checkbox"/>	<input checked="" type="checkbox"/>	<input checked="" type="checkbox"/>										
<input checked="" type="checkbox"/>	<input checked="" type="checkbox"/>	<input checked="" type="checkbox"/>	<input checked="" type="checkbox"/>	<input checked="" type="checkbox"/>										
<input checked="" type="checkbox"/>	<input checked="" type="checkbox"/>	<input checked="" type="checkbox"/>	<input checked="" type="checkbox"/>	<input checked="" type="checkbox"/>										
<input checked="" type="checkbox"/>	<input checked="" type="checkbox"/>	<input checked="" type="checkbox"/>	<input checked="" type="checkbox"/>	<input checked="" type="checkbox"/>										
<input checked="" type="checkbox"/>	<input checked="" type="checkbox"/>	<input checked="" type="checkbox"/>	<input checked="" type="checkbox"/>	<input checked="" type="checkbox"/>										
<input checked="" type="checkbox"/>	<input checked="" type="checkbox"/>	<input checked="" type="checkbox"/>	<input checked="" type="checkbox"/>	<input checked="" type="checkbox"/>										
<input checked="" type="checkbox"/>	<input checked="" type="checkbox"/>	<input checked="" type="checkbox"/>	<input checked="" type="checkbox"/>	<input checked="" type="checkbox"/>										
<input checked="" type="checkbox"/>	<input checked="" type="checkbox"/>	<input checked="" type="checkbox"/>	<input checked="" type="checkbox"/>	<input checked="" type="checkbox"/>										
<input checked="" type="checkbox"/>	<input checked="" type="checkbox"/>	<input checked="" type="checkbox"/>	<input checked="" type="checkbox"/>	<input checked="" type="checkbox"/>										
<input checked="" type="checkbox"/>	<input checked="" type="checkbox"/>	<input checked="" type="checkbox"/>	<input checked="" type="checkbox"/>	<input checked="" type="checkbox"/>										
					<input checked="" type="checkbox"/>	<input checked="" type="checkbox"/>	<input checked="" type="checkbox"/>	<input checked="" type="checkbox"/>	<input checked="" type="checkbox"/>	<input checked="" type="checkbox"/>	<input checked="" type="checkbox"/>	<input checked="" type="checkbox"/>	<input checked="" type="checkbox"/>	<input checked="" type="checkbox"/>
					<input checked="" type="checkbox"/>	<input checked="" type="checkbox"/>	<input checked="" type="checkbox"/>	<input checked="" type="checkbox"/>	<input checked="" type="checkbox"/>	<input checked="" type="checkbox"/>	<input checked="" type="checkbox"/>	<input checked="" type="checkbox"/>	<input checked="" type="checkbox"/>	<input checked="" type="checkbox"/>
					<input checked="" type="checkbox"/>	<input checked="" type="checkbox"/>	<input checked="" type="checkbox"/>	<input checked="" type="checkbox"/>	<input checked="" type="checkbox"/>	<input checked="" type="checkbox"/>	<input checked="" type="checkbox"/>	<input checked="" type="checkbox"/>	<input checked="" type="checkbox"/>	<input checked="" type="checkbox"/>
					<input checked="" type="checkbox"/>	<input checked="" type="checkbox"/>	<input checked="" type="checkbox"/>	<input checked="" type="checkbox"/>	<input checked="" type="checkbox"/>	<input checked="" type="checkbox"/>	<input checked="" type="checkbox"/>	<input checked="" type="checkbox"/>	<input checked="" type="checkbox"/>	<input checked="" type="checkbox"/>
					<input checked="" type="checkbox"/>	<input checked="" type="checkbox"/>	<input checked="" type="checkbox"/>	<input checked="" type="checkbox"/>	<input checked="" type="checkbox"/>	<input checked="" type="checkbox"/>	<input checked="" type="checkbox"/>	<input checked="" type="checkbox"/>	<input checked="" type="checkbox"/>	<input checked="" type="checkbox"/>
					<input checked="" type="checkbox"/>	<input checked="" type="checkbox"/>	<input checked="" type="checkbox"/>	<input checked="" type="checkbox"/>	<input checked="" type="checkbox"/>	<input checked="" type="checkbox"/>	<input checked="" type="checkbox"/>	<input checked="" type="checkbox"/>	<input checked="" type="checkbox"/>	<input checked="" type="checkbox"/>
<input checked="" type="checkbox"/>	<input checked="" type="checkbox"/>	<input checked="" type="checkbox"/>	<input checked="" type="checkbox"/>	<input checked="" type="checkbox"/>										
<input checked="" type="checkbox"/>	<input checked="" type="checkbox"/>	<input checked="" type="checkbox"/>	<input checked="" type="checkbox"/>	<input checked="" type="checkbox"/>										
<input checked="" type="checkbox"/>	<input checked="" type="checkbox"/>	<input checked="" type="checkbox"/>	<input checked="" type="checkbox"/>	<input checked="" type="checkbox"/>										
<input checked="" type="checkbox"/>	<input checked="" type="checkbox"/>	<input checked="" type="checkbox"/>	<input checked="" type="checkbox"/>	<input checked="" type="checkbox"/>										
<input checked="" type="checkbox"/>	<input checked="" type="checkbox"/>	<input checked="" type="checkbox"/>	<input checked="" type="checkbox"/>	<input checked="" type="checkbox"/>										
<input checked="" type="checkbox"/>	<input checked="" type="checkbox"/>	<input checked="" type="checkbox"/>	<input checked="" type="checkbox"/>	<input checked="" type="checkbox"/>										

COLORS	Art.												
		41	49	37	35	52	53	54	55	56	B41	B49	B52
Moon	5520CL / 5521	✓	✓	✓	✓	✓	✓	✓	✓	✓			
	5522CL / 5523	✓	✓	✓	✓	✓	✓	✓	✓	✓			
	5524CL / 5525	✓	✓		✓	✓	✓	✓	✓	✓			
	5501 / 5502	✓	✓	✓	✓	✓	✓	✓	✓	✓			
	5503 / 5504 / 5505	✓	✓	✓	✓	✓	✓	✓	✓	✓			
	5506 / 5507 / 5508	✓	✓										
	5509 / 5510	✓	✓										
	5511 / 5512	✓	✓										
Teorema 2.0	5126TW	✓	✓	✓	✓	✓	✓	✓	✓	✓	✓	✓	✓
	5126CL / 5127	✓	✓	✓	✓	✓	✓	✓	✓	✓			
	5138CL / 5139	✓	✓	✓	✓	✓	✓	✓	✓	✓			
	5101 / 5102	✓	✓	✓	✓	✓	✓	✓	✓	✓			
	5111 / 5112	✓	✓										
	5104	✓	✓	✓	✓								
	5105 / 5110	✓	✓	✓	✓	✓	✓	✓	✓	✓			
	5114 / 5117 / 5115	✓	✓			✓	✓	✓	✓	✓			
	5118 / 5123 / 5119	✓	✓			✓	✓	✓	✓	✓			
	5120 / 5124	✓	✓			✓	✓	✓	✓	✓			
	5121 / 5122 / 5125	✓	✓										
	5106/R-100A	✓	✓			✓	✓	✓	✓	✓			
	5106/R-100B	✓	✓			✓	✓	✓	✓	✓			
	5107/R-120A	✓	✓										
	5107/R-120B	✓	✓										
	5142	✓	✓			✓	✓	✓	✓	✓			
	5143 / 5116	✓	✓										
	5108 / 5109	✓	✓										
	5130 / 5131 / 5132		✓										
	5133 / 5134 / 5135		✓										
5136 / 5137		✓											
Glam	5201TW	✓	✓	✓	✓	✓	✓	✓	✓	✓	✓	✓	✓
	5202	✓	✓	✓	✓	✓	✓	✓	✓	✓			
	1809	✓	✓										
	1808 / 1807 / 1806 / 1804	✓	✓	✓	✓	✓	✓	✓	✓	✓			
	1803	✓	✓										
	1802	✓	✓	✓	✓	✓	✓	✓	✓	✓			
	1801 / 1811 / 1812	✓	✓										
	1813 / 1813B	✓	✓										
	1805 / 1810	✓	✓										
Veil	6101 / 6102	✓	✓	✓	✓	✓	✓	✓	✓				
Soft	1501 / 1502 / 1503	✓	✓	✓									
Hung	1511 / 1512 / 1513	✓	✓	✓									
Cube	1521 / 1522 / 1523	✓	✓	✓									
Thin Line	8045 / 8009 / 8011	✓	✓	✓	✓	✓	✓	✓	✓				
Up	1890 / 1891	✓	✓					✓	✓	✓			
Cross	2501 / 2502	✓	✓		✓	✓	✓	✓	✓	✓			
	2713 / 2714	✓	✓		✓	✓	✓	✓	✓	✓			
Diva	2715 / 2716 / 2717	✓	✓		✓	✓	✓	✓	✓	✓			
	2709 / 2710	✓	✓		✓	✓	✓	✓	✓	✓			

DecorART	Art.	 F	 G	 E
Moon	5501	✓	✓	✓
	5502	✓	✓	✓
	5503	✓	✓	✓
	5504	✓	✓	✓
	5505	✓	✓	✓
	5507	✓	✓	✓
Teorema 2.0	5101	✓	✓	✓
	5102	✓	✓	✓
	5129	✓	✓	✓
	5111	✓	✓	✓
	5112	✓	✓	✓
	5104	✓	✓	✓
	5105	✓	✓	✓
	5114	✓	✓	✓
	5117	✓	✓	✓
	5110	✓	✓	✓
	5115	✓	✓	✓
	5118	✓	✓	✓
	5123	✓	✓	✓
	5108	✓	✓	✓
	5109	✓	✓	✓
5130	✓	✓	✓	
5131	✓	✓	✓	
5132	✓	✓	✓	
Glam	1809	✓	✓	✓
	1808	✓	✓	✓
	1807	✓	✓	✓
	1806	✓	✓	✓
	1804	✓	✓	✓
	1802	✓	✓	✓
	1811	✓	✓	✓
Diva	1805	✓	✓	✓
	1810	✓	✓	✓
	2709	✓	✓	✓
	2710	✓	✓	✓
	2715	✓	✓	✓
	2716	✓	✓	✓
2717	✓	✓	✓	

IT) Consigli per la pulizia e la manutenzione del bagno

Tutti i nostri prodotti, realizzati con materiali selezionati e sottoposti a tutti i controlli qualità, sono stati concepiti per durare a lungo nel tempo. Eventuali piccole alterazioni di colore o tono che si possono riscontrare tra gli oggetti sono sinonimo di produzione manuale, non industriale e garantiscono l'unicità del prodotto. Sono pertanto da considerate come caratteristiche di pregio e non difetti oggetto di contestazione. Un'accurata manutenzione ed alcuni piccoli accorgimenti permetteranno di conservare i sanitari sempre come nuovi, mantenendo intatte quelle caratteristiche estetiche e funzionali che determinano l'unicità e l'artigianalità dei prodotti Scarabeo. Il nostro consiglio è di utilizzare sempre una spugna morbida per la pulizia dei lavabi e sanitari e di evitare l'uso di sostanze abrasive, caustiche o aggressive che possono rovinare od opacizzare la ceramica. Per un'igiene più sicura e per rimuovere gli eventuali residui di calcare o di sapone è consigliabile procedere periodicamente ad una pulizia più approfondita utilizzando sempre e comunque un detergente non abrasivo. Un regolare lavaggio con acqua tiepida e sapone, avendo cura di asciugare le superfici con un panno morbido subito dopo l'uso ed una particolare attenzione a non usare oggetti appuntiti o particolarmente ruvidi, saranno sufficienti per mantenere in perfette condizioni il nostro prodotto nel vostro bagno.

EN) Advice on bathroom cleaning and maintenance

All our products are manufactured with carefully selected materials, undergo strict quality controls and are designed to last. The minor alterations in colour or shade of the various items are the result of manual and not industrial production and guarantee a unique product. They should therefore be considered as precious features and not defects to complain about. Careful maintenance and several simple actions ensure that sanitary ware remains as good as new and retains the visual and functional features that guarantee the uniqueness and craftsmanship of Scarabeo products. We suggest always using a damp sponge to clean the washbasins and sanitary ware. Avoid using abrasive, caustic or aggressive products that could damage or dull the ceramic. To ensure perfect hygiene and remove any traces of limescale or soap, it is recommended to clean them thoroughly every now and then, although again using a non-abrasive detergent. Wash our bathroom products regularly with warm water and soap and dry the surfaces thoroughly with a soft cloth after use, and also avoid using sharp or particularly rough objects, to ensure they remain in perfect condition.

FR) Conseils pour le nettoyage et l'entretien de la salle de bain

Tous nos produits sont réalisés à l'aide de matériaux triés sur le volet et soumis à tous les contrôles de qualité nécessaires. Ils ont été conçus afin de résister à l'épreuve du temps. Les petites altérations de couleur ou de ton qui peuvent apparaître sont le résultat d'un processus de production à la main, non industriel. Elles garantissent le caractère unique du produit. Ce sont donc des critères de luxe et ne sont en aucun cas des défauts pouvant faire l'objet d'une réclamation. Un entretien minutieux et le respect de plusieurs conseils vous permettront de préserver votre salle de bain et tous les aspects esthétiques et fonctionnels qui confèrent aux produits Scarabeo leur caractère unique et artisanal. Nous vous conseillons donc d'utiliser toujours une éponge douce pour nettoyer les lavabos et les sanitaires. Évitez les produits abrasifs, caustiques ou agressifs qui pourraient endommager ou matifier la céramique. Pour un nettoyage en toute sécurité et pour éliminer les traces de calcaire ou de savon, procédez à un nettoyage plus approfondi à l'aide d'un détergent non abrasif en toutes circonstances. Effectuez un lavage régulier à l'eau tiède et au savon, en veillant à sécher les surfaces à l'aide d'un chiffon doux directement après utilisation. Veillez à ne pas utiliser d'objets pointus ou rugueux. Vous pourrez ainsi garantir l'état de nos produits et de votre salle de bain.

DE) Empfehlungen für die Reinigung und Instandhaltung des Bades

Alle unsere Produkte sind auf Langlebigkeit ausgelegt, da sie nur aus sorgfältig ausgewählten Materialien hergestellt und strengen Qualitätskontrollen unterzogen werden. Eventuelle geringfügige Farbtonabweichungen zwischen den einzelnen Produkten sind Merkmale der handwerklichen Verarbeitung und garantieren deren Einzigartigkeit. Daher sind solche Abweichungen Qualitätsmerkmale und stellen keine Mängel dar, die Gegenstand von Reklamationen sein könnten. Bei korrekter Pflege und richtiger Behandlung bleiben Ihre Sanitärprodukte über lange Zeit in einem einwandfreien Zustand und erhalten die ästhetischen und funktionellen Eigenschaften, die für die Einzigartigkeit und handwerkliche Verarbeitung der Produkte von Scarabeo charakteristisch sind. Wir empfehlen die Reinigung der Waschbecken und Sanitärprodukte mit einem weichen Schwamm. Vermeiden Sie bitte den Einsatz von Scheuermitteln, ätzenden oder auf sonstige Weise aggressiven Substanzen, die die Oberflächen der Keramik beschädigen oder ihren Glanz beeinträchtigen können. Für eine sichere Hygiene und zur Entfernung von Kalkablagerungen oder Seifenresten empfehlen wir, regelmäßig eine gründlichere Reinigung mit einem grundsätzlich nicht scheuernden Reinigungsmittel durchzuführen. Regelmäßiges Spülen mit lauwarmem Wasser und Seife, nachfolgendes Trocknen mit einem weichen Tuch und das Vermeiden von Kontakt mit spitzen oder sehr rauen Gegenständen ist völlig ausreichend, um die Sanitärprodukte in Ihrem Bad in einem perfekten Zustand zu erhalten.

ES) Consejos para la limpieza y el mantenimiento del baño

Todos nuestros productos, realizados con materiales seleccionados y sometidos a todos los controles de calidad, han sido diseñados para durar a lo largo del tiempo. Es posible que se produzcan pequeñas alteraciones del color o del tono, características de la elaboración manual, no industrial, garantía del carácter único del producto. Por eso deben considerarse características de valor y no defectos de fabricación a reclamar. El mantenimiento preciso y algunas pequeñas precauciones permiten mantener los sanitarios como nuevos, sin que se alteren las características estéticas y funcionales que los hacen únicos y aseguran el carácter artesanal de los productos Scarabeo. Nuestro consejo es utilizar siempre una esponja suave para la limpieza de los lavabos y sanitarios y evitar el uso de sustancias abrasivas, cáusticas o agresivas que podrían arruinar la cerámica y quitarle brillo. Para una higiene más segura y para quitar posibles residuos calcáreos o de jabón se aconseja periódicamente realizar una limpieza más profunda empleando un detergente no abrasivo. Un lavado frecuente con agua tibia y jabón, teniendo cuidado de secar las superficies con un paño blando inmediatamente después del uso, sin utilizar objetos puntiagudos o ásperos, será suficiente para mantener el sanitario en perfectas condiciones.

RU) Рекомендации по очистке и уходу за ванной комнатой

Все наши товары, выполненные из тщательно отобранных материалов, прошедших весь необходимый контроль качества, были разработаны таким образом, чтобы обеспечить длительный срок эксплуатации. Небольшие отклонения цвета или тона, которые, возможно, Вы встретите, являются следствием того, что товары не были произведены в серийном производстве, но являются результатом ручной работы, и свидетельствуют об их уникальности. Поэтому они должны рассматриваться как ценные характеристики, а не дефекты, являющиеся поводом для рекации. Благодаря тщательному уходу и соблюдению некоторых несложных мер предосторожности, Ваши сантехнические изделия всегда будут как новые, и сохранятся эстетические и эксплуатационные характеристики, которые определяют уникальность и самобытность, присущие товарам компании Scarabeo. Рекомендуем Вам при очистке умывальников и сантехнических изделий всегда использовать мягкую губку и не прибегать к использованию абразивных, едких или агрессивных веществ, которые могут нанести вред керамическим изделиям или привести к помутнению их покрытия. Для обеспечения более строгой гигиены, а также для удаления возможных остатков известковых отложений или мыла рекомендуется периодически выполнять углубленную очистку, всегда используя для этого неабразивное чистящее средство. С тем, чтобы наши сантехнические товары, которые Вы выбрали для ванной комнаты, сохранили свое прекрасное состояние, будет достаточно регулярной мойки теплой водой с мылом и аккуратной протирки поверхностей мягкой тканевой салфеткой сразу же после использования. Необходимо также тщательно следить за тем, что Вы не используете заостренные или очень шероховатые предметы.

CONDIZIONI GENERALI DI VENDITA

01) IVA. Tutti i prezzi nel presente listino si intendono escluso IVA.

02) CONSEGNE. Le merci sono vendute franco fabbrica.

La società fornitrice "Scarabeo Ceramiche S.r.l." si riserva il diritto di spedire un ordine in più di una consegna, a seconda della disponibilità del prodotto in magazzino. Nel caso in cui i colli non risultino intatti al momento del loro arrivo, il Cliente lo annoterà sulla bolla di consegna e informerà la società fornitrice entro 5 giorni dalla consegna delle merci.

03) ACCETTAZIONE DEGLI ORDINI. Gli ordini emessi ai nostri agenti di zona, anche quando essi sono sottoscritti, dovranno in ogni caso essere accettati da "Scarabeo Ceramiche S.r.l.".

04) RESPONSABILITÀ. La società fornitrice, previa autorizzazione, accetterà unicamente quei resi che saranno stati riconosciuti come difettosi a causa di difetti di produzione e provvederà ad accreditare al Cliente l'importo dei resi meno le spese di trasporto oppure si riserva il diritto di sostituire i resi difettosi. Ogni altro provvedimento, indennizzo o risarcimento per danni diretti o indiretti causati dall'installazione di merci difettose, rimane escluso.

05) TERMINI DI CONSEGNA. La data di consegna espressa nella conferma è da intendersi puramente indicativa e non vincolante. Le consegne saranno programmate in considerazione dei requisiti dei nostri Clienti, restando ben inteso che la società fornitrice si riserva il diritto di modificare la programmazione delle consegne. Qualsiasi responsabilità da parte della società fornitrice per ritardi nelle consegne o per consegne mancate rimane esclusa, indipendentemente dalla causa.

06) PAGAMENTI. I termini di pagamento saranno quelli riportati sulla conferma d'ordine.

La società fornitrice si riserva il diritto di interrompere o annullare una fornitura nel caso in cui i pagamenti non vengono effettuati nel rispetto delle date di scadenza e nei metodi concordati. I pagamenti si considerano effettuati dal Cliente solo nel momento in cui il relativo importo sarà stato accreditato sul conto corrente della società fornitrice.

Eventuali controversie di qualsiasi natura non danno al Cliente il diritto di interrompere i pagamenti in corso.

Gli ordini per un valore imponibile inferiore a Euro 250,00 saranno spediti in contrassegno, o previo pagamento anticipato.

7) CESSIONE DEL CREDITO. Scarabeo Ceramiche srl, potrà cedere o trasferire, in tutto o in parte, i crediti derivanti dalle forniture effettuate, senza il preventivo consenso del Cliente.

08) IMBALLAGGIO. L'imballaggio deve essere effettuato per mezzo di imballi standard (pallet, scatole, ecc.) e gli imballi specifici eventualmente utilizzati saranno annotati sulle singole conferme d'ordine. Il costo è a carico del Cliente.

09) RECLAMI. Ciascuna partita sarà ritenuta accettata dopo otto giorni dal ricevimento delle merci senza che sia stato avanzato alcun reclamo.

10) NUMERI DI CODICE. I prodotti devono essere ordinati in base al numero del loro codice di identificazione.

11) CARATTERISTICHE TECNICHE. "Scarabeo Ceramiche S.r.l." si riserva il diritto di modificare le caratteristiche tecniche dei prodotti in qualsiasi momento con lo scopo di migliorare i prodotti stessi o per interrompere la produzione di modelli in un qualsiasi momento senza alcun preavviso.

12) FORO COMPETENTE. Per ogni controversia tra "Scarabeo Ceramiche S.r.l." e il cliente, l'unico foro competente è e sarà sempre il tribunale di Viterbo.

13) E-COMMERCE. A tutela del marchio e delle nostre politiche commerciali, per coloro che hanno intenzione di effettuare vendite tramite internet (e-commerce) del nostro prodotto, è assolutamente necessario attenersi alle seguenti disposizioni:

a) Necessità di ricevere richiesta scritta dell'intenzione di effettuare vendite tramite internet (e-commerce) specificando :

1) Ragione sociale se diversa

2) Nome del sito, indirizzo, pec, interlocutore

3) Allegare visura camerale

b) Dopo valutazione interna la Scarabeo Ceramiche srl provvederà ad emettere autorizzazione scritta.

c) L'autorizzazione di Scarabeo Ceramiche srl riguarda solo ed esclusivamente il sito riportato nella richiesta. Per siti collegati e/o nuovi bisogna ripetere iter.

d) Potranno essere utilizzate soltanto immagini tratte dai nostri cataloghi ufficiali, l'uso di immagini dovrà essere autorizzato dalla Scarabeo Ceramiche srl.

e) Il mancato rispetto degli accordi, comporterà l'immediata interruzione di ogni fornitura, senza la necessità di alcun preavviso da parte di Scarabeo ceramiche srl.

Il presente listino prezzi annulla ogni listino prezzi precedente.
Le dimensioni e i pesi riportati nel presente listino prezzi sono approssimativi.

GENERAL SALES CONDITIONS

01) DELIVERY. Goods are sold ex factory.

The supplying company "Scarabeo Ceramiche S.r.l." reserves the right to despatch an order in more than one delivery depending on the actual product availability in their warehouses. Should the packages not be intact upon arrival, it is the Client's duty to report this on the delivery note and to inform the supplying company within 5 days of delivery of the goods.

02) ORDER ACCEPTANCE. Orders issued to our area agents, even when undersigned, are understood to be subject to acceptance by "Scarabeo Ceramiche S.r.l.".

03) LIABILITY. The supplying company, subject to authorisation, shall accept only those returned goods recognised as faulty due to manufacturing defects and shall credit the amount of the returned goods minus transport costs to the Client, or shall reserve the right to replace the faulty goods returned. Any other actions, refund or compensation whatsoever for indirect and direct damages caused by the installation of the faulty goods remains excluded.

04) DELIVERY TERMS. The date is purely indicative and is not binding. Deliveries will be programmed taking into consideration the requirements of our Clients, it being understood that the supplying company reserves the right to change the delivery programme. Any liability whatsoever on the part of the supplying company for delivery delays or missed deliveries remains excluded, whatever the cause may be.

05) PAYMENTS. The terms of payment are those indicated on the order confirmation.

The supplier company reserves the right to suspend or cancel a supply if the payments are not made according to the due dates and in the methods agreed. Payments are considered as made by the Customer only at the moment when the relative sum has been credited into the current account of the supplier company.

Disputes of any nature will not give the Customer the right to suspend current payments.

Orders for a taxable value under Euro 250.00 will be shipped cash on delivery, or with payment beforehand.

06) ASSIGNMENT OF CREDIT. Scarabeo Ceramiche srl may assign or transfer, in full or in part, the credit resulting from the supplies made, without the Customer's prior consent.

07) PACKAGING. Packaging is carried out using standard packaging (pallets, boxes, etc.) and specific type of packaging used shall be noted on the individual order confirmations. The cost is payable by the Client (5% increase pallets - boxes).

08) COMPLAINTS. Dach consignment is understood to be accepted after eight days have passed from receipt of good Without any complaint having been lodged.

09) CODE NUMBERS. Products must be order by their identification code number.

10) TECHNICAL FEATURES. "Scarabeo Ceramiche S.r.l." reserves the right to modify the technical features of the products at any time in order to improve the product itself, or to interrupt productions of models at any time whatsoever without giving any prior notice.

11) LEGAL RESIDENCE. For any controversy whatsoever between "Scarabeo Ceramiche S.r.l." and the customer, the Court of Viterbo is and always will be the only place of jurisdiction.

12) E-COMMERCE.

In order to safeguard our brand and commercial policies, subjects who intend selling our product via the Internet (e-commerce) must observe the following rules:

a) A written application indicating the intention to sell via the Internet (e-commerce) must be submitted, specifying:

1) Company name (if different)

2) Name of the website, address, certified e-mail (PEC), contact person

3) Chamber of commerce company registration certificate

b) After an internal assessment, Scarabeo Ceramiche srl will issue the written authorisation.

c) The authorisation of Scarabeo Ceramiche srl relates solely and exclusively to the website indicated in the application. The process must be repeated for related and/or new websites.

d) Only images taken from our official catalogues may be used; the use of any image must be authorised by Scarabeo Ceramiche srl.

e) Failure to observe the agreements shall imply the immediate interruption of supplies, without prior notice on the part of Scarabeo Ceramiche srl.

This price list cancels all previous ones.

The sizes and Weights stated in this price list are understood to be approximate.

CONDITIONS GENERALES DE VENTE

01) LIVRAISONS. Les marchandises sont vendues départ l'usine.

Le fournisseur "Scarabeo Ceramiche S.r.l." se réserve le droit d'envoyer une commande en sus d'une livraison en fonction de la disponibilité du produit. Si les colis sont endommagés à la réception, le Client en fera mention sur le bordereau de livraison et en informera le fournisseur dans les cinq jours à compter de la livraison des marchandises.

02) ACCEPTATION DES COMMANDES. Les commandes émises à l'attention de nos intermédiaires locaux, même si elles sont dûment signées, devront au préalable être acceptées par "Scarabeo Ceramiche S.r.l."

03) RESPONSABILITES. Le fournisseur, moyennant autorisation préalable, acceptera uniquement les renvois de marchandises jugées défectueuses en raison de défaut de fabrication. La société veillera à rembourser au Client le prix des marchandises renvoyées à l'exception des frais de renvoi ou procédera à l'échange des produits défectueux.

Toute autre disposition, indemnité ou tout autre dédommagement pour les dommages directs et indirects causés par l'installation des marchandises défectueuses sont exclus.

04) DELAIS DE LIVRAISON. La date est purement indicative et n'est pas contractuelle. Les livraisons seront programmées en fonction des exigences de nos Clients sans préjudice du fait que le fournisseur se réserve le droit de modifier le programme des livraisons.

Le fournisseur décline toute responsabilité en cas de retard ou d'absence de livraison quelle qu'en soit la cause.

05) PAIEMENTS. Les délais de paiement figurent sur la confirmation de commande.

Le fournisseur se réserve le droit de suspendre ou annuler la livraison au cas où les paiements ne seraient pas effectués avant la date d'échéance de la facture et selon les méthodes convenues. Les paiements seront réputés effectués par le Client exclusivement à partir du moment où le montant correspondant sera crédité sur le compte du fournisseur.

Les litiges quels qu'ils soient ne confèrent en aucun cas au Client le droit de suspendre les paiements échus.

Les commandes d'une valeur imposable inférieure à 250,00 EUR seront envoyées moyennant paiement à la livraison ou après réception du paiement.

06) CESSIION DE CREDIT. Scarabeo Ceramiche srl se réserve le droit de céder ou transférer, intégralement ou en partie, les crédits dérivant des livraisons effectuées sans accord préalable du Client.

07) CONDITIONNEMENT. L'emballage peut être effectué à l'aide de moyens traditionnels (palettes, boîtes, etc.).

Les emballages spécifiques éventuellement utilisés seront mentionnés sur la confirmation de la commande.

Les frais sont à charge du Client (augmentation de 5 % pour palettes - boîtes).

08) RECLAMATIONS. Les lots seront réputés acceptés si aucune réclamation n'est envoyée dans les huit jours suivant la réception des marchandises.

09) NUMEROS DE CODE. Les produits doivent être classés en fonction de leur code d'identification.

10) CARACTERISTIQUES TECHNIQUES. "Scarabeo Ceramiche S.r.l." se réserve le droit de modifier les caractéristiques techniques des produits à tout moment en vue d'améliorer les produits en question ou d'interrompre la production des modèles à tout moment et sans préavis.

11) TRIBUNAL COMPETENT. Le tribunal de Viterbo connaîtra des litiges éventuels entre "Scarabeo Ceramiche S.r.l." et le Client.

12) LIVRAISON DES MARCHANDISES, SONT VENDUES DEPART USINE

13) E-COMMERCE.

Conformément à notre marque et nos politiques commerciales, toute personne ayant l'intention de proposer des ventes par Internet (e-commerce) pour nos produits devra respecter les conditions suivantes :

a) réception d'une demande écrite de l'intention d'effectuer des ventes par Internet (e-commerce) en précisant :

1) raison sociale (si différente)

2) nom du site, adresse, adresse e-mail certifiée, personne de contact

3) annexe l'extrait du registre des entreprises

b) après l'évaluation interne, Scarabeo Ceramiche srl rédigera une autorisation écrite.

c) L'autorisation de Scarabeo Ceramiche srl concerne exclusivement le site figurant dans la demande. Pour les sites connexes et/ou récents, il convient de réitérer la demande.

d) Seules les images provenant des catalogues officiels sont autorisées. Les autres images nécessiteront l'accord de Scarabeo Ceramiche srl.

e) Le non-respect des accords impliquera l'interruption immédiate de toute livraison sans préavis de la part de Scarabeo Ceramiche srl.

La présente liste des prix annule et remplace la précédente.

Les dimensions et les poids indiqués dans le présent catalogue sont approximatifs.

ALLGEMEINE VERKAUFSBEDINGUNGEN

01) LIEFERUNGEN. Die Waren werden frei Werk verkauft.

Die Lieferfirma "Scarabeo Ceramiche S.r.l." behält sich das Recht vor, gegebenenfalls eine Bestellung in mehreren Lieferungen zu verschicken, je nach der Verfügbarkeit des Produkts im Lager. Falls die Frachtstücke bei ihrer Ankunft nicht unversehrt sein sollten, muss der Kunde dies auf dem Lieferschein vermerken und die Lieferfirma innerhalb von 5 Tagen ab Warenerhalt benachrichtigen.

02) ANNAHME DER BESTELLUNGEN. Die von unseren Gebietsvertretern angenommenen Bestellungen müssen, auch wenn sie unterzeichnet sind, auf jeden Fall von der Gesellschaft "Scarabeo Ceramiche S.r.l." bestätigt werden.

03) HAFTUNG. Die Lieferfirma nimmt nach vorheriger Genehmigung ausschließlich jene Retourwaren an, die aufgrund von Herstellungsfehlern als fehlerhaft anerkannt werden. Anschließend stellt sie dem Kunden eine Gutschrift mit dem Betrag der Retourware, abzüglich Transportkosten, aus bzw. behält es sich vor, die fehlerhafte Ware zu ersetzen. Jede andere Maßnahme, Entschädigung oder Schadensersatz für direkte oder indirekte Schäden, die durch den Einbau fehlerhafter Ware hervorgerufen wird, ist ausgeschlossen.

04) LIEFERFRISTEN. Das Datum ist als ungefähres Datum anzusehen und somit nicht bindend. Die Lieferungen werden unter Berücksichtigung der Erfordernisse unserer Kunden geplant, wobei sich die Lieferfirma Planungsänderungen vorbehält. Jede Haftung seitens der Lieferfirma für verspätete oder verhinderte Auslieferung ist ausgeschlossen, unabhängig von der Ursache.

05) ZAHLUNGEN Die Zahlungsfristen sind auf der Bestellbestätigung angegeben.

Der Lieferant behält sich das Recht vor, Lieferungen zu unterbrechen oder zu stornieren, falls die Zahlungen nicht zu den Fälligkeitsterminen und mit den vereinbarten Modalitäten eingehen. Zahlungen des Kunden gelten erst als geleistet, nachdem der entsprechende Betrag auf dem Girokonto des Lieferanten eingegangen ist.

Eventuelle Kontroversen beliebiger Art geben dem Kunden nicht das Recht, laufende Zahlungen einzustellen.

Bestellungen mit einem Nettowert unter 250,00 Euro können per Nachnahme oder im Voraus bezahlt werden.

06) FORDERUNGSABTRETUNG Scarabeo Ceramiche Srl hat das Recht, Forderungen aus erfolgten Lieferungen ohne vorherige Zustimmung des Kunden vollständig oder teilweise abzutreten.

07) VERPACKUNG. Die Verpackung erfolgt mit traditionellen Verpackungsmitteln (Paletten, Schachteln usw.); falls spezifische Verpackungen benutzt werden, sind diese auf den einzelnen Auftragsbestätigungen angegeben.

Die Kosten gehen zu Lasten des Kunden (5 % Erhöhung für Paletten und Schachteln).

08) MÄNGELRÜGEN. Jeder Posten gilt als angenommen, wenn innerhalb von acht Tagen ab Erhalt der Ware keine Mängelrüge vorgebracht wird.

09) CODENUMMERN. Die Produkte müssen mit der Nummer ihres Identifikationscodes bestellt werden.

10) TECHNISCHE PRODUKTEIGENSCHAFTEN. Die Gesellschaft "Scarabeo Ceramiche S.r.l." behält es sich vor, die technischen Produkteigenschaften jederzeit zum Zweck der Produktverbesserung zu verändern, bzw. die Produktion der Modelle jederzeit und ohne Vorankündigung einzustellen.

11) GERICHTSSTAND. Für jede Streitigkeit zwischen der "Scarabeo Ceramiche S.r.l." und dem Kunden ist allein das Gericht Viterbo zuständig.

12) E-COMMERCE.

Zum Schutz unseres Markenzeichens und unserer Handelspolitik müssen alle, die beabsichtigen, unsere Produkte über Internet (e-commerce) zu verkaufen, die folgenden Bestimmungen unbedingt beachten:

a) Bitte stellen Sie einen schriftlichen Antrag auf Online-Verkauf (E-Commerce) mit folgenden Angaben:

1) Unternehmensbezeichnung, sofern abweichend

2) Name der Website, Postadresse, zertifizierte E-Mail-Adresse, Ansprechpartner

3) Handelsregisterauszug als Anhang

b) Nach der internen Prüfung stellt die Scarabeo Ceramiche Srl eine schriftliche Genehmigung aus.

c) Die Genehmigung der Scarabeo Ceramiche Srl gilt ausschließlich für die im Antrag genannten Aktivitäten. Für verknüpfte und/oder weitere Websites muss ein neuer Antrag gestellt werden.

d) Es dürfen ausschließlich Abbildungen aus unseren offiziellen Produktkatalogen verwendet werden. Die Nutzung von Fotos muss außerdem von der Scarabeo Ceramiche Srl genehmigt werden.

e) Die Nichtbeachtung der Vereinbarungen führt zum sofortigen Lieferstopp ohne vorherige Ankündigung durch Scarabeo Ceramiche srl.

Diese Preisliste ersetzt jede vorherige Preisliste.

Die in dieser Preisliste angeführten Abmessungen und Gewichte sind als ungefähre Angaben anzusehen.

CONDICIONES GENERALES DE VENTA

01) ENTREGA. Los productos se entregan franco fábrica. La empresa proveedora "Scarabeo Ceramiche S.r.l." se reserva el derecho completar un pedido en varias entregas conforme las existencias en su almacén. Si en el momento de recibir el pedido los bultos no estuvieran intactos, el cliente anotará el hecho en los documentos de entrega y lo comunicará a la empresa vendedora antes de transcurridos 5 días desde la fecha de entrega.

02) ACEPTACIÓN DE PEDIDOS. Los pedidos formulados a nuestros agentes de zona, aunque estén firmados, están sujetos a la aceptación por parte de "Scarabeo Ceramiche S.r.l.".

03) RESPONSABILIDAD. La empresa proveedora, una vez dada la autorización, aceptará únicamente la devolución de aquellos artículos en que se hayan comprobado defectos de fabricación; acreditará al cliente el importe de la devolución menos los gastos de transporte o, en su lugar, se reserva el derecho de reemplazar los artículos defectuosos. Queda excluida toda otra acción, indemnización o resarcimiento por daños directos o indirectos provocados por la instalación de productos defectuosos.

04) TÉRMINOS DE ENTREGA. La fecha es meramente indicativa y no constituye un vínculo. Las entregas se programarán según las necesidades de nuestros clientes, sin perjuicio del derecho de la empresa proveedora de modificar la programación de las entregas. La empresa proveedora declina toda responsabilidad por retardos en las entregas o por entregas no efectuadas, cualquiera sea la causa.

05) PAGOS. Las condiciones de pago se indican en la confirmación del pedido.

El proveedor se reserva el derecho de interrumpir o anular un suministro si los pagos no se efectúan dentro de los plazos y con los métodos acordados. Los pagos se considerarán efectuados por el Cliente sólo en el momento en que el importe se acredite en la cuenta corriente del proveedor.

Eventuales controversias de cualquier naturaleza no darán al Cliente derecho a interrumpir los pagos en curso.

Los pedidos de un valor imponible inferior a 250,00 euros serán enviados con pago contra entrega, o previo pago anticipado.

06) CESIÓN DEL CRÉDITO. Scarabeo Ceramiche srl podrá ceder o transferir total o parcialmente los créditos derivados de los suministros efectuados, sin el consentimiento del Cliente.

07) EMBALAJE. Para el envío de los productos se utilizarán embalajes estándar (palés, cajas u otros); en caso de utilizarse embalajes específicos, esto se anotará en el pedido en firme. El coste corre por cuenta del cliente (aumento del 5% palés, cajas).

08) RECLAMACIONES. Transcurridos ocho días desde la recepción de un pedido sin que se hayan presentado reclamaciones, la mercadería se considerará aceptada.

09) NÚMEROS DE CÓDIGO. Los productos se pedirán según el número del código que los identifica.

10) CARACTERÍSTICAS TÉCNICAS. "Scarabeo Ceramiche S.r.l." se reserva el derecho de modificar en cualquier momento y sin aviso previo las características técnicas de los productos, con la finalidad de mejorarlos o de interrumpir la producción de modelos.

11) FUERO COMPETENTE. Ante cualquier controversia que pudiera surgir entre "Scarabeo Ceramiche S.r.l." y el cliente, el único fuero competente presente y futuro es únicamente el tribunal de Viterbo.

12) COMERCIO ELECTRÓNICO

En defensa de la marca y de nuestras políticas comerciales, para quienes tengan la intención de realizar ventas por Internet (comercio electrónico) de nuestro producto, es absolutamente necesario atenerse a las siguientes disposiciones:

a) Necesidad de recibir solicitud escrita de la intención de efectuar ventas por Internet (comercio electrónico) especificando:

1) Razón social, si es diferente

2) Nombre del sitio, dirección, correo electrónico certificado, interlocutor

3) Adjuntar visorio de la Cámara de Comercio

b) Después de una evaluación interna, Scarabeo Ceramiche srl emitirá la autorización por escrito.

c) La autorización de Scarabeo Ceramiche srl concierne sola y exclusivamente al sitio indicado en la solicitud. Para sitios asociados o nuevos es necesario repetir el procedimiento.

d) Podrán utilizarse sólo imágenes extraídas de nuestros catálogos oficiales; el uso de imágenes deberá estar autorizado por Scarabeo Ceramiche srl.

e) El incumplimiento de los acuerdos implicará la inmediata interrupción de todo tipo de suministro, sin necesidad de preaviso por parte de Scarabeo Ceramiche srl.

Esta lista de precios anula toda otra lista de precios anterior.
Las medidas y pesos indicados en esta lista de precios son aproximados.

ОБЩИЕ УСЛОВИЯ ПРОДАЖИ

01) НДС. Предполагается, что все цены, представленные в настоящем прайс-листе, не включают НДС.

02) ПОСТАВКИ. Продажа товаров осуществляется на условиях «франко-завод».

Компания-поставщик Scarabeo Ceramiche S.r.l. оставляет за собой право отгружать товар по одному заказу за несколько поставок, в зависимости от наличия продукции на складе. В случае если грузы на момент прибытия имеют нарушения целостности, Клиент должен сделать об этом запись в транспортной накладной и информировать компанию-поставщика в течение 5 дней с момента получения груза.

03) ПРИЕМКА ЗАКАЗОВ. Заказы, сделанные нашими региональными агентами, даже в случае их подписания, должны в любом случае подвергаться приемке со стороны Scarabeo Ceramiche S.r.l.

04) ОТВЕТСТВЕННОСТЬ. Компания-поставщик, после соответствующего утверждения, принимает исключительно те возвраты, которые будут признаны дефектными по причине нарушения технологического процесса, и примет меры по перечислению на счет Клиента суммы возврата за вычетом затрат на транспортировку, либо оставит за собой право на замену дефектных возвращенных изделий. Любые другие меры, возмещение убытков или компенсации в связи с прямым или косвенным ущербом, понесенным в результате установки дефектных товарных единиц, – исключаются.

05) УСЛОВИЯ ПОСТАВКИ. Дата поставки, указанная в подтверждении заказа, считается чисто индикативной и не является обязательной. Поставки будут планироваться, исходя из требований наших Клиентов, при условии, что компания-поставщик оставляет за собой право на внесение изменений в запланированные поставки. Исключается какая бы то ни было ответственность со стороны компании-поставщика за невыполнение сроков поставки или за недопоставку вне зависимости от причин.

6) ПЛАТЕЖИ. Условия оплаты будут такими, как указано в подтверждении заказа.

Компания-поставщик сохраняет за собой право приостановить или отменить поставку, если оплата не совершена в установленный срок и согласованным способом. Платежи считаются произведенными Клиентом только в тот момент, когда соответствующая сумма зачислена на расчетный счет компании-поставщика.

Споры какого бы то ни было характера не дают Клиенту права приостанавливать текущие платежи.

Заказы налогооблагаемой стоимостью меньше 250,00 евро отправляются на условиях оплаты наложенным платежом или предоплаты.

7) УСТУПКА ПРАВА ТРЕБОВАНИЯ. Компания Scarabeo Ceramiche srl имеет право полностью или частично уступать или передавать права требования, возникшие в связи с выполненными поставками, без предварительного согласия Клиента.

08) УПАКОВКА. Упаковка должна осуществляться с использованием стандартных средств упаковки (паллеты, ящики и т. д.), а специальные средства, которые используются в определенных случаях, должны указываться в отдельных подтверждениях заказов. Затраты берет на себя Клиент.

09) РЕКЛАМАЦИИ. Любая партия будет считаться принятой по прошествии восьми дней с момента получения товара, если не имели место какие-либо рекламации.

10) КОДОВЫЕ НОМЕРА. Изделия должны заказываться с использованием идентифицирующих их кодовых номеров.

11) ТЕХНИЧЕСКИЕ ХАРАКТЕРИСТИКИ. Компания Scarabeo Ceramiche S.r.l. оставляет за собой право на внесение в любое время изменений в технические характеристики продукции, направленных на ее улучшение, либо на приостановку выпуска моделей в любое время без предварительного извещения.

12) КОМПЕТЕНТНЫЙ СУД. В случае возникновения споров между Scarabeo Ceramiche S.r.l. и Клиентом, единственным компетентным судом является и всегда будет являться суд города Витербо.

13) ПРОДАЖИ ЧЕРЕЗ СЕТЬ ИНТЕРНЕТ (E-COMMERCE)

С целью защиты товарного знака и наших политик в коммерческой сфере обязательным условием для тех, кто намеревается осуществлять продажи нашей продукции в сети Интернет (e-commerce), является выполнение следующих положений:

а) Предоставить письменный запрос о намерении осуществлять продажи через сеть Интернет (e-commerce), указав в нем следующую информацию: 1) Название компании, если отличается. 2) Название сайта, адрес, сертифицированная электронная почта, контактное лицо. 3) Прикрепить выписку из торгового реестра.

б) После анализа документов компания Scarabeo Ceramiche srl предоставит письменное разрешение.

в) Разрешение, предоставленное Scarabeo Ceramiche srl, действительно только и исключительно для сайта, указанного в запросе. Для новых и/или аффилированных сайтов требуется повторить процедуру.

д) Разрешается использовать только изображения, полученные из наших официальных каталогов. Для использования изображений необходимо получить разрешение компании Scarabeo Ceramiche srl.

е) Нарушение согласованных положений повлечет за собой немедленное прекращение всяких поставок без необходимости каких-либо предварительных уведомлений со стороны Scarabeo Ceramiche srl.

Настоящий прайс-лист заменяет собой все другие прайс-листы, выпущенные ранее.
Размеры и веса, указанные в настоящем прайс-листе, являются приблизительными.

Art.	Pag.	Art.	Pag.	Art.	Pag.	Art.	Pag.	Art.	Pag.
1001	155	2110SX	288	2715	248	5119	29	5325	184
1002	155	2111	290/304	2716	248	5120	30	5326	186
1501	100	2112	290/304	2717	248	5121	31	5327	186
1502	100	2113	290/304	2901	216	5122	32	5328	186
1503	100	2114	290/304	2902	216	5123	28	5329	186
1511	101	2115	291/305	2903	216	5124	30	5330	186
1512	101	2116	291/305	2905	218/233	5125	32	5331	186
1513	101	2117	291/305	2906	218/233	5126CL	20	5332	187
1521	102	2118	289	2907	218/233	5126TW	20	5333	187
1522	102	2201	298	2908	219/234	5127	20	5334	187
1523	102	2202	298	2909	219/234	5129	24	5335	188
1801	52	2203	298	2910	217	5130	34	5336	188
1802	52	2204	298	2911	217	5131	34	5337	188
1803	51	2205	299	2912	217	5132	34	5338	189
1804	51	2206	299	2913	217	5133	35	5339	189
1805	54	2207	299	2914	218/233	5134	35	5340	188
1806	51	2208	299	2916	219/234	5135	36	5341	188
1807	50	2209	300	3001	114	5136	36	5342	188
1808	50	2210	300	3002	114	5137	36	5343	189
1809	50	2301	240/301	3003	115	5138CL	21	5344	189
1810	54	2302	240/301	3004	114	5139	22	5345	189
1811	52	2303	241	3005	115	5140CL	22	5346	189
1812	53	2304	240/301	3006	115	5141	22	5347	187
1813	53	2305	241	3007	116	5142	30	5348	187
1813B	53	2306	241	3008	116	5143	32	5349	176
1830	266	2310	198	3009	116	5146	42	5350	185
1831	266	2311	198	4001	194	5147	42	5351	187
1832	266	2312	198	4002	194	5148	42	5352	182
1833	267	2313	199	4003	194	5149	43	5355	181
1834	267	2314	199	4004	195	5150	43	5356A	182
1835	267	2315	201	4005	195	5151	43	5356B	182
1836	268	2316	201	4006	192	5153	35	5357A	182
1837	268	2317A	199	4007	192	5154	37	5357B	182
1838	268	2317B	199	4008	193	5155	25	5359	183
1839	269	2318A	200	4009	193	5156	26	5360	183
1840	269	2318B	200	4010A	193	5201TW	48	5364	178
1841	270/303	2319A	200	4010B	193	5202	48	5365	178
1842	270/303	2319B	200	4012	196	5210	157	5501	13
1843	270/303	2401	210	4013	196	5211	157	5502	13
1844	278	2402	210	4014	196	5212	157	5503	13
1845	278	2403	211/300	4015	196	5301	180	5504	14
1846	278	2404	210/300	4016	196	5302	180	5505	14
1847	279	2501	228	4017	196	5303	180	5506	14
1890	173	2502	228	4018	197	5304	181	5507	15
1891	173	2504	229	4019	197	5305	181	5508	15
2011	170	2551	232	5001	130	5306	176	5509	15
2012	170	2552	232	5002	130	5307	176	5510	16
2014	171	2553	232	5003	130	5308	177	5511	17
2100	284	2701	244	5101	24	5309	177	5512	17
2101	284	2702	244	5102	24	5309B	177	5520CL	8
2102	284	2703	244	5104	26	5310A	179	5521	8
2103DX	285	2704	245/302	5105	26	5310B	179	5522CL	9
2103SX	285	2705	245	5108	33	5315	185	5523	9
2104DX	286	2706	245	5109	33	5316	185	5524CL	11
2104SX	286	2707	246	5110	27	5317	185	5525	11
2105	286	2708	247	5111	25	5318	185	5526A	12
2107	287	2709	247	5112	25	5319	185	5526B	12
2108DX	287	2710	247	5114	27	5320	184	5526CL	10
2108SX	287	2711	246	5115	28	5321	184	5527	10
2109	288	2712	246	5116	33	5322	184	5530A	12
2110	285	2713	211/229/248/261	5117	27	5323	184	5530A	49
2110DX	288	2714	211/229/248/261	5118	28	5324	184	5530B	12

Art.	Pag.	Art.	Pag.	Art.	Pag.	Art.	Pag.	Art.	Pag.
5530B	49	8046	106	8703A	127	10042	39/117/135	DIV7	251
5531	16	8046R	106	8703B	127	10043	39/135	FO1	242
5553A	179	8047A	161	8801	60	10044	117	FO2	242
5553B	179	8047B	162	8802	60	10045	39/135	FO3	242
6001	86	8047D	162	8803	60	10046	39/117/135	FO4	243
6002	86	8051	143	8804	61	10047	310	FO5	243
6003	86	8051R	143	8805	64	10048	312	FO6	243
6004	87	8052	143	8806	64	10050/A	311	FR201	280
6005	89	8052R	144	8807	61	10050/B	311	FR202	280
6006	89	8053	144	8808	61	10050/C	311	FR203	280
6007	89	8053R	144	8809	62	10060	38	FRM1	271
6008	89	8054	145	8810	62	10060	134	FRM2	271
6009	90	8054R	145	8811	62	10061	38/134	FRM3	271
6010	90	8055	138	8812	58	10062	38/134	FRM4	272
6011	90	8055A	138	8812CL	58	10063	38/134	FRM5	272
6012	90	8055AR	139	8813	58	10064	38	FRM6	272
6013	87	8055R	138	8814A	59	10065	38	FRM7	273
6014	87	8056	139	8814B	59	10066	157	FRM8	273
6015	88	8056A	140	8815	59	10067	157	FU1	262
6016	260	8056AR	140	8816	63	5106R100A	29	FU2	262
6018	260	8056R	139	8816A	59	5106R100B	29	FU3	262
6020	88	8089	121	8817	63	5107R120A	31	FU4	263
6101	82	8090	121	8818	64	5107R120B	31	PHRM1	292
6102	82	8091	121	8819	63	8031-40	128	PHRM2	292
6103	83	8092	122	8820	64	8031-60	128	PHRM3	292
6104	83	8093	159	8821	64	8031-80	129	PHRM4	293
8003	169	8093B	159	8822	63	8031R100A	132	PHRM5	293
8007A	152	8094	159	9001	94	8031R100B	133	PHRM6	293
8007B	152	8097	165	9002	95	8031R120A	133	PLN1	235
8007D	152	8098	165	9003	94	8031R120B	133	PLN2	235
8007E	153	8104	73	9004	95	8031R40	131	PLN3	235
8008	169	8105	68	9005	94	8031R41X23	129	PLN4	236
8009	107	8105CL	68	9006	96	8031R60	132	PLN5	236
8009R	107	8106	68	9007	95	8031R80	132	PLN6	236
8010	108	8108A	70	9008	96	8047D80	163	PO101	306
8010R	108	8108B	70	9009	97	AB1	212	PO102	306
8011	108	8109	71	9010	97	AB2	212	PO103	306
8020	168	8110	71	10004A	310	AB3	212	PO104	307
8021	168	8111	72	10004B	310	DIV1	249	PO105	307
8025A	151	8112	72	10005	310	DIV2	249	PO106	307
8025B	151	8206	170	10006	311	DIV21	251	SLD1	202
8025D	151	8207	169	10007	309	DIV22	251	SLD2	202
8029	109	8305A	23	10008	309	DIV23	252	SLD3	202
8029D	109	8305B	23	10009	309	DIV24	252	SLD4	203
8029R	109	8306	161	10010	308	DIV24b	252	SOL1	220
8030	110	8307	161	10010C	308	DIV25	253	SOL2	220
8030R	110	8308	162	10012	310	DIV26	253	SOL21	222
8031	128	8401	69	10014	311	DIV26b	253	SOL22	222
8031D	131	8403	69	10014A	311	DIV27	254	SOL23	222
8031R	131	8404	70	10014B	311	DIV28	254	SOL24	223
8032	120	8601	78	10016	312	DIV29	254	SOL25	223
8033	120	8602	78	10019	309	DIV3	249	SOL26	223
8034	168	8603	79	10022	10/22/312	DIV30	255	SOL3	220
8035	134	8604	76	10026	308	DIV31	255	SOL4	221
8036	129	8605	76	10028	311	DIV31b	255	SOL5	221
8037	120	8606	77	10029	312	DIV32	256	SOL6	221
8038	148	8607	77	10030	310	DIV32b	256		
8038R	149	8609A	77	10032	309	DIV33	256		
8039	148	8609B	77	10034	308	DIV34	257		
8039R	148	8610	78	10035	308	DIV4	250		
8044	107	8701	126	10040	135	DIV5	250		
8045	106	8702	126	10041	39/135	DIV6	250		

DecorLAB - POIS

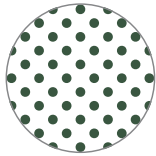

SEV
GREEN

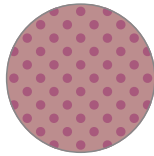

SER
PINK



SEM
BROWN

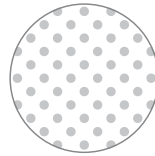

SENT
NEUTRAL

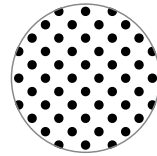

SENR
BLACK

DecorLAB - FULL POIS

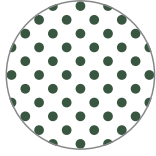

SFLV
GREEN

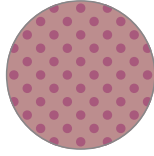

SFLR
PINK



SFLM
BROWN

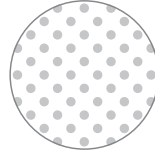

SFLNT
NEUTRAL

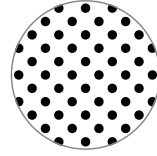

SFLNR
BLACK

Interno / esterno - Internal / external - Interne / externe - Intern / extern - Interno / externo - Внутренний / внешний

DecorLAB - LINE



REV
GREEN

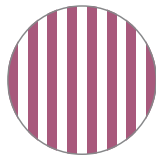

RER
PINK



REM
BROWN

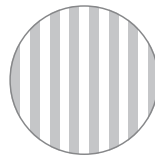

RENT
NEUTRAL

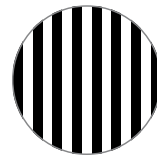

RENR
BLACK

DecorLAB - POIS STRIP

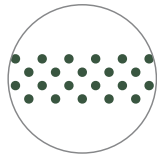

FSV
GREEN

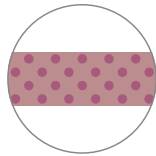

FSR
PINK

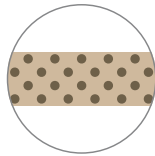

FSM
BROWN

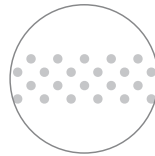

FSNT
NEUTRAL

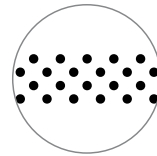

FSNR
BLACK

Interno / esterno - Internal / external - Interne / externe - Intern / extern - Interno / externo - Внутренний / внешний

DecorLAB - LINE STRIP



RRV
GREEN

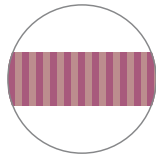

RRR
PINK



RRM
BROWN

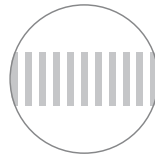

RRNT
NEUTRAL

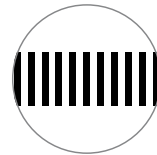

RRNR
BLACK

Interno / esterno - Internal / external - Interne / externe - Intern / extern - Interno / externo - Внутренний / внешний

COLORS



41
PEARL



49
ARDESIA



37
LAVA



35
NIGHT



52
SAND



53
TOBACCO



54
ANTIQUÉ PINK



55
MUSK



56
OCEAN

BICOLORS



B41
BICOLORS
PEARL



B49
BICOLORS
ARDESIA



B52
BICOLORS
SAND

DecorART

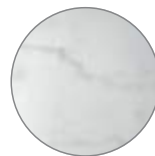

F
MARBLE WHITE

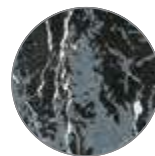

G
MARBLE BLACK

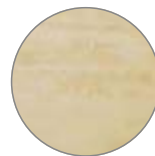

E
TRAVERTINE

METALS



BS
MATT WHITE



49
MATT ARDESIA

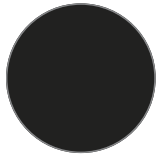

NROP
MATT BLACK

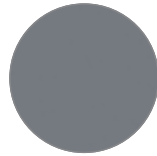

GRG
MATT GRAY

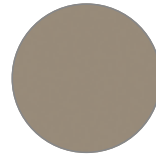

TRT
MATT TAUPE



ORS
BRUSHED GOLD

WOOD - FRAME

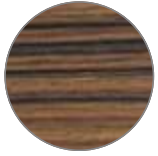

87
MACASSAR

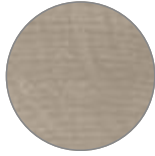

88
ROVERE BRIZZO



89
ROVERE NODATO



90
STRATOS

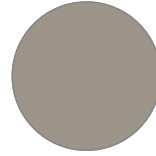

91
SABBIA

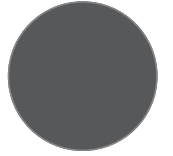

92
ANTRACITE

WOOD - FRAME 2.0 - SLIDE - ABLE - SOLID - DIVA - FUJI

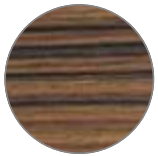

87
MACASSAR



88
ROVERE BRIZZO



89
ROVERE NODATO

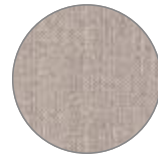

96
ALPACA



97
CESIO

NEW WOOD - SOLID - DIVA

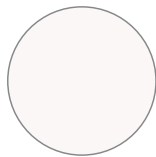

93
LACQUER WHITE



49
MATT BLACK

WOOD - CROSS



98
LIGHT WOODEN FINISH



99
DARK WOODEN FINISH

WOOD - PHORMA

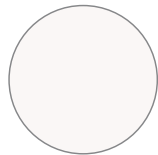

93
LACQUER WHITE



94
EGO CHIARO

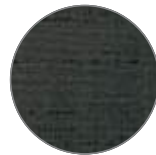

95
EGO SCURO



F1
LACQUER WHITE-EGO CHIARO



F2
LACQUER WHITE-EGO SCURO



F3
EGO CHIARO-LACQUER WHITE



F4
EGO SCURO-LACQUER WHITE

BUCKET DECORATIONS



PSA
FISHING HOOK



RZZ
ROCKET



R
JUMPING FISH



S
DROP



T
PAINT



X
SMALL FISHES



Y
ORANGE



K
PORTHOLE



U
BASKET



V
SWALLOWS



W
LACE



Z
PIXELS



MOS
MOSCOW



DXB
DUBAI



SYD
SYDNEY



ROM
ROME



LON
LONDON



TKY
TOKYO



SHA
SHANGHAI



NYC
NEW YORK



PAR
PARIS



CR
CHROMIUM



TOWEL RAIL
BS
SATIN WHITE



NS
SATIN BLACK

LA NOSTRA RETE VENDITA
OUR SALES ORGANIZATION - RESEAU COMMERCIAL
VERKAUFSNETZ - NUESTRA RED DE VENTAS - НАША ТОРГОВАЯ СЕТЬ



TUTTI I NOSTRI PRODOTTI SONO IDEATI PROGETTATI E COMPLETAMENTE REALIZZATI NEI NOSTRI STABILIMENTI DI FABRICA DI ROMA - VT - ITALIA
ALL OUR PRODUCTS ARE CONCEIVED, DESIGNED AND ENTIRELY MANUFACTURED IN OUR PRODUCTION PLANTS LOCATED IN FABRICA DI ROMA (PROVINCE OF VITERBO) - ITALY
TOUS NOS PRODUITS SONT CRÉÉS, CONÇUS ET ENTIÈREMENT RÉALISÉS DANS NOTRE USINE DE FABRICA DI ROMA (VT) - ITALIE
ALLE UNSERE PRODUKTE WERDEN IN UNSEREN WERKEN IN ROM (VT) – ITALIEN ERDACHT, ENTWORFEN UND KOMPLETT HERGESTELLT:
TODOS NUESTROS PRODUCTOS SE DISEÑAN Y REALIZAN PLENAMENTE EN NUESTRAS FÁBRICAS EN FABRICA DI ROMA (VT) - ITALIE
ВСЕ НАШИ ИЗДЕЛИЯ ЗАДУМАНЫ, СПРОЕКТИРОВАНЫ И ПОЛНОСТЬЮ ИЗГОТОВЛЕНЫ НА НАШИХ ПРОИЗВОДСТВЕННЫХ ПРЕДПРИЯТИЯХ В РИМЕ - ВТ - ИТАЛИЯ

REPLACEMENT PROCEEDINGS

Dear Client,

In order to handle complaints at the best, please, comply with the following proceedings:

- 1- Send photos (possibly more than one) of faulty goods (if possible by highlighting the fault with a felt-tip pen) to: tecnico@scarabeosrl.com;
- 2- Should we require the return of faulty goods to check them, please, remember that:
 - a) we don't return broken goods, so no credit note will follow;
 - b) the fault must be highlighted on every faulty article;
 - c) we don't return unpacked goods;
 - d) goods must be packed with care (boxes or pallet). When possible, please, use the same original package (please, don't use brown adhesive tape because it can not be removed from ceramics).
- 3- Please, draw up a delivery note and specify "faulty goods returned". We check the goods as soon as we receive them. Should we notice the fault, a credit note will follow briefly.

NB. Should the goods be sent by express courier, please, note that every complaints for breakage will be taken into consideration only if we receive a regular claim with some photos of the broken piece and the package within 7 (seven) days after delivery of goods.

PROCEDURE S.A.V.

Cher Client,

afin de gérer au mieux les éventuelles réclamations sur le matériel fourni par SCARABEO, nous vous prions de bien vouloir vous conformer à la procédure suivante:

- 1- Envoyer les photos (si possible plus d'une) du défaut noté (si possible en le mettant en évidence avec un crayon feutre) à l'adresse: tecnico@scarabeosrl.com;
- 2- Au cas où nous demandions la reprise du matériel défectueux pour le contrôler, nous vous rappelons que:
 - a) la marchandise cassée NE peut PAS être reprise pourtant elle NE peut PAS être créditée;
 - b) le défaut doit être mis en évidence avec un crayon feutre sur chaque pièce défectueuse;
 - c) il n'est pas possible de reprendre le matériel sans carton;
 - d) le matériel ne sera repris que bien emballé dans des cartons ou sur palette. Si possible, merci d'utiliser le même emballage utilisé par le transporteur qui a livré (merci de ne pas utiliser le ruban adhésif marron, car il ne peut pas être enlevé de la céramique);
- 3- Merci de rédiger un bordereau de livraison en spécifiant « matériel rendu non-conforme ». Lors de la réception du matériel nous vérifierons l'état de la marchandise. Si on reconnaîtra le défaut, on fera l'avoir.

NB. Pour ce qui est du matériel livré par courrier express, nous vous rappelons que, afin de prendre en considération vos réclamations, elles doivent nous parvenir dans les 7 (sept) jours à partir de la réception de la marchandise en même temps que les photos du matériel cassé et de l'emballage.

Sehr geehrter Kunde,

für die Verwaltung eventueller Beanstandungen am von uns gelieferten Material bitten wir Sie, den nachfolgend beschriebenen Vorgang zu beachten:

- 1- Senden Sie an die E-Mailadresse tecnico@scarabeosrl.com die Fotos des festgestellten Fehlers (möglichst mehrere Fotos) und, wenn möglich, kennzeichnen Sie den Fehler mit einem Filzstift;
- 2- Sollten wir die die Abholung des fehlerhaften Materials für eventuelle Kontrollen anfordern, denken Sie daran:
 - a) kaputte Teile können NICHT abgeholt und somit gutgeschrieben werden;
 - b) auf jedem Teil muss der Fehler mit einem Filzstift gekennzeichnet sein;
 - c) es können keine losen Einzelteile abgeholt werden;
 - d) das Material wird nur abgeholt, wenn es entsprechend in Kartons oder auf Paletten verpackt ist. Wenn möglich verwenden Sie die gleiche Verpackung des Kuriers, der die Zustellung ausgeführt hat (verwenden Sie bitte kein braunes Klebeband, da sich dieses nicht von der Keramik abziehen lässt);
- 3- Bitte stellen Sie einen Lieferschein aus und geben Sie als Grund 'Rückgabe von nicht konformem Material' an. Sobald wir die Ware erhalten, werden wir sie gründlich prüfen; wenn der Fehler anerkannt wurde, werden wir eine Gutschrift über die fehlerhaften Teile ausstellen.
N.B. wurde das Material mit Expresskurier zugestellt, denken Sie bitte daran, dass eventuelle Beanstandungen für beschädigt eingegangenes Material ausschließlich dann berücksichtigt werden können, wenn eine ordentliche Schadensanzeige mit Fotos des beschädigten Teils und der Verpackung innerhalb von 7 (sieben) Tagen nach Eingang der Ware gemacht wurde.

PROCEDIMIENTOS DE SUSTITUCIÓN

Estimado Cliente,

para gestionar las reclamaciones lo mejor posible, le rogamos respete los procedimientos siguientes:

- 1- Enviar unas fotografías (posiblemente más de una) de los productos defectuosos (marcando si posible el defecto con un rotulador) a: tecnico@scarabeosrl.com;
- 2- En caso de devolución de los productos defectuosos para un control, le rogamos recordar que:
 - a) no aceptamos la devolución de productos dañados y no emitiremos ninguna nota de crédito para ellos;
 - b) el defecto debe estar marcado en cada producto defectuoso;
 - c) no aceptamos la devolución de mercancía sin embalaje;
 - d) los productos tienen que estar embalados de forma adecuada (cajas o paletas). Cuando posible, le rogamos utilizar el embalaje original (le rogamos también no utilizar cinta adhesiva de color marrón puesto que resulta imposible quitarla de la cerámica).
- 3- Le rogamos redacte una nota de entrega, indicando "devolución de productos defectuosos". Controlaremos los productos en cuando los recibamos. En caso de encontrar el defecto, emitiremos a continuación una nota de crédito.

NB. En el caso de que los productos se envíen por mensajería exprés, le rogamos tome nota de que las reclamaciones por daños se considerarán sólo al recibir una reclamación oficial acompañada por unas fotografías de la pieza dañada y el embalaje dentro de 7 (siete) días después de la entrega

ПОРЯДОК ЗАМЕНЫ

Уважаемый клиент,

для оптимального обращения с комплектующими просим следовать следующему порядку:

- 1- Отправьте фотографии (по возможности несколько) бракованных товаров (по возможности выделив брак маркером) на: tecnico@scarabeosrl.com;
- 2- Если мы затребуем вернуть бракованные изделия для их проверки, помните следующее:
 - a) мы не возвращаем обратно поврежденные изделия, так что их не будет сопровождать никаких платежных счетов;
 - b) брак должен быть выделен на каждом бракованном изделии;
 - c) мы не возвращаем обратно распакованные товары;
 - d) товары должны быть тщательно упакованы (в коробках или на поддонах). По возможности просим использовать оригинальную заводскую упаковку (просим не использовать коричневый скотч, потому что его трудно удалить с керамики).
- 3- Просим составить накладную и указать "возврат бракованных товаров". Мы проверим товары, как только мы их получим. Если мы обнаружим брак, в ближайшее время мы вышлем платежный счет.

ПРИМЕЧАНИЕ Если товары отправляются экспресс-курьером, просим отметить, чтобы все жалобы на брак были учтены, только если мы получим правильную рекламацию с несколькими фотографиями поврежденных изделий и упаковку в течение 7 (семи) дней с даты отправки товаров.

Variazioni nelle dimensioni comprese tra $\pm 5\%$

La società si riserva il diritto di apportare modifiche ai prodotti in qualsiasi momento senza preavviso.

Dimension tolerance $\pm 5\%$

The company reserves the right to make changes without prior notice.

Variations des dimensions comprises entre + ou - 5%

Notre société se réserve le droit d'apporter des modifications à ses produits à tout moment et sans obligation de préavis.

Änderungen der Abmessungen liegen bei $\pm 5\%$

Das Unternehmen behält sich das Recht vor, jederzeit und ohne Vorankündigung Änderungen an den Produkten vorzunehmen.

Variaciones de medidas comprendidas entre $\pm 5\%$

La empresa se reserva el derecho de modificar los productos en cualquier momento y sin aviso previo.

Изменение размеров в рамках $\pm 5\%$

Компания оставляет за собой право вносить изменения в изделия в любое время без предварительного предупреждения.