

price list

New
products 2024



hand made in italy

cielo

INDICE

INDEX

Filo	p. 05
Otis	p. 31
Itaca	p. 45
Kanto	p. 87
Delfo	p. 115

Filo

design Giuseppe Pezzano e Andrea Parisio

indice collezione \ collection index pg. 07

modulo d'ordine \ order form pg. 10 - 17

listino prezzi \ price list pg. 18 -29

Washbasins and shelf finishes

Acabados de Lavabos y top \ Finitions des Lavabos et plan \ Waschbecken - Platte Farbe \ столешница - Отделки Раковина

Essential Colors

-  Gloss White
-  Gloss Black
-  FU - Fumo **NEW**
-  TP - Talpa **NEW**

Cabinet, base unit and shelf finishes



Acabados para mueble, base, estante \ finitions pour le meuble, base, étagère | Für Möbel, Waschbeckenunterbau, Regal Farbe | отделка доступна для ящика, Лакированное основание, Полочка

-  FU - Fumo **NEW**
-  TP - Talpa **NEW**

Le Terre di Cielo



-  TL - Talco
-  PM - Pomice
-  BR - Brina
-  CM - Cemento
-  BA - Basalto
-  LV - Lavagna
-  FN - Fango
-  CA - Cacao
-  AN - Arenaria
-  AV - Avena
-  MU - Muschio
-  AG - Agave
-  LN - Lino
-  CN - Canapa
-  CP - Cipria
-  PL - Polvere

Le Acque di Cielo

-  OL - Oltremare
-  SM - Smeraldo
-  AL - Alga
-  CO - Corallo
-  NI - Ninfea
-  AM - Anemone

(Top)

(Encimera \ Plaque \ Regal \ столешница)

-  Bianco Carrara Gioia
-  Nero Marquina

Le Terre di Cielo

-  TL - Talco
-  PM - Pomice
-  BR - Brina
-  CM - Cemento
-  BA - Basalto
-  AN - Arenaria
-  AV - Avena
-  MU - Muschio
-  AG - Agave **NEW**

Essenze

-  Rovere Sbiancato
-  Rovere Naturale
-  Rovere Tinto Noce **NEW**
-  Rovere Nero
-  Eucalipto

Le Acque di Cielo

-  OL - Oltremare
-  SM - Smeraldo
-  AL - Alga
-  CO - Corallo
-  NI - Ninfea
-  AM - Anemone

Available finishes for container mirrors

Acabado estructura espejo contenedor / Finitions structure miroir avec rangement / Ausführung Spiegelschrank / Зеркальный верный шкафчик с крашенной рамой

lacquering / lacados / laquages / Lackierungen / Крашенная отделка

-  NM - Matt Black
-  CM - Cemento
-  FU - Fumo **NEW**
-  TP - Talpa **NEW**

Le Acque di Cielo

lacquering / lacados / laquages / Lackierungen / Крашенная отделка

-  OL - Oltremare
-  SM - Smeraldo
-  AL - Alga
-  CO - Corallo
-  NI - Ninfea
-  AM - Anemone

The possible variations of the colour cannot be considered as defect, but as a guarantee of the completely artisan manufacturing of this unique and high quality product. / Las variaciones de colores no se consideran un defecto sino una garantía de una elaboración manual y artesanal en un producto único y de calidad. / Les éventuelles variations de couleur ne peuvent être considérées comme des défauts, elles témoignent en revanche d'une méthode de travail totalement manuelle et artisanale employée pour obtenir un produit fini unique et de qualité. / Eventuelle Farbvariationen sind nicht als Mangel anzusehen, sondern als Garantie für die komplett handwerkliche Anfertigung eines einzigartigen und hochqualitativen Produkts. / Возможные вариации цвета не могут считаться дефектом, а являются подтверждением ручной работы, гарантией качества и уникальности изделия.

Lavabi con mobile / washbasins with cabinet



FILASPR58
Lavabo sottopiano
Undercounter washbasin
cm 58 x 35 x 15 h
pag. 18

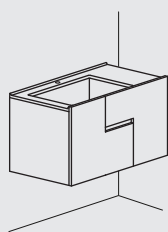

Lavabo con mobile 90 maniglia orizzontale - sx
Washbasin on the left with Filo 90 cabinet with horizontal handle
cm 90 x 55 x 45 h
pag. 20

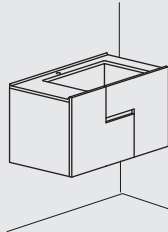

Lavabo con mobile 90 maniglia orizzontale - dx
Washbasin on the right with Filo 90 cabinet with horizontal handle
cm 90 x 55 x 45 h
pag. 20

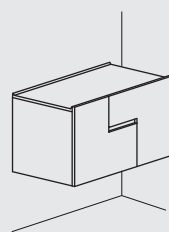

Mobile 90 maniglia orizzontale senza lavabo
Filo 90 cabinet with horizontal handle no washbasin
cm 90 x 55 x 45 h
pag. 20

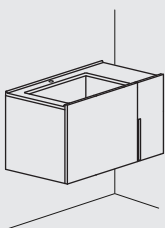

Lavabo con mobile 90 maniglia verticale - sx
Washbasin on the left with Filo 90 cabinet with vertical handle
cm 90 x 55 x 45 h
pag. 22

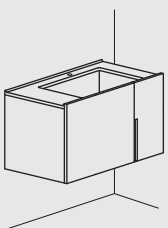

Lavabo con mobile 90 maniglia verticale - dx
Washbasin on the right with Filo 90 cabinet with vertical handle
cm 90 x 55 x 45 h
pag. 22

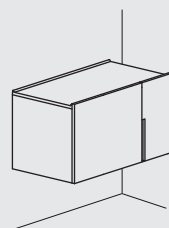

Mobile 90 maniglia verticale senza lavabo
Filo 90 cabinet with vertical handle no washbasin
cm 90 x 55 x 45 h
pag. 22

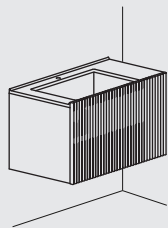

Lavabo con mobile 90 con doghe - sx
Washbasin on the left with Filo 90 cabinet in wood with slatted front
cm 90 x 55 x 45 h
pag. 24

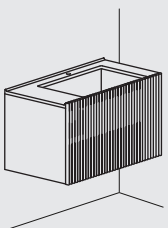

Lavabo con mobile 90 con doghe - dx
Washbasin on the right with Filo 90 cabinet in wood with slatted front
cm 90 x 55 x 45 h
pag. 24

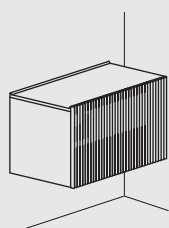

Mobile 90 con doghe senza lavabo
Filo 90 cabinet in wood with slatted front no washbasin
cm 90 x 55 x 45 h
pag. 24

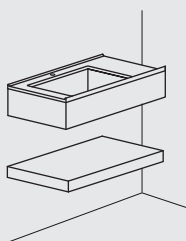

Lavabo con mensola - sx
Washbasin on the left with shelf
cm 90 x 55 x 21 h (fascione\base unit)
cm 90 x 50 x 7 h (mensola\shelf)
pag. 26

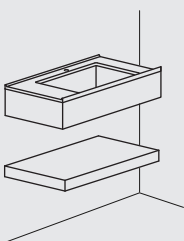

Lavabo con mensola - dx
Washbasin on the right with shelf
cm 90 x 55 x 21 h (fascione\base unit)
cm 90 x 50 x 7 h (mensola\shelf)
pag. 26

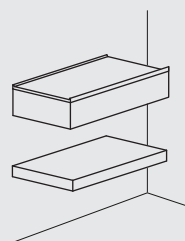

Mensola senza lavabo
Shelf without washbasin
cm 90 x 55 x 21 h (fascione\base unit)
cm 90 x 50 x 7 h (mensola\shelf)
pag. 26

Specchi / mirrors

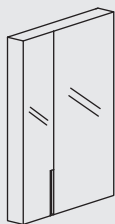

Specchio contenitore con luce led, fianchi a specchio, versione destra
Filo container mirror, right version, shell with mirrored sides
cm 90 x 13 x 110 h
pag. 28

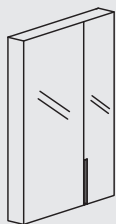

Specchio contenitore con luce led, fianchi a specchio, versione sinistra
Filo container mirror, left version, shell with mirrored sides
cm 90 x 13 x 110 h
pag. 28

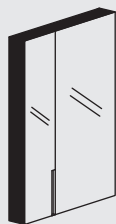

Specchio contenitore con luce led, laccato, versione destra
Filo container mirror, right version, shell with lacquered sides
cm 90 x 13 x 110 h
pag. 28

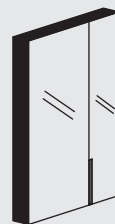

Specchio contenitore con luce led, laccato, versione sinistra
Filo container mirror, left version, shell with lacquered sides
cm 90 x 13 x 110 h
pag. 28



modelli disponibili / available models

FILO
collection

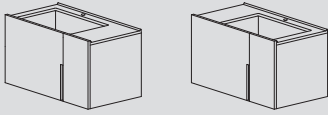

Mobile Filo 90 con maniglia verticale
Filo cabinet 90 with vertical handle



finiture / finishes

LAVABO IN CERAMICA / CERAMIC WASHBASIN

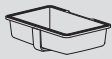

FILASPR58

Le Terre di Cielo



Le Acque di Cielo



Essential colors

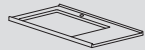

FIP90SX (ceramic)
FIP90MSX (marble)

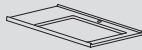

FIP90DX (ceramic)
FIP90MDX (marble)

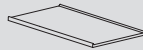

FIP90 (ceramic)
FIP90M (marble)

PIANO IN CERAMICA / CERAMIC TOP

Le Terre di Cielo

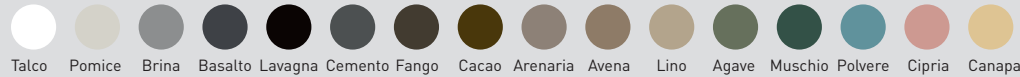

PIANO IN CERAMICA / CERAMIC TOP

Le Acque di Cielo



Essential colors

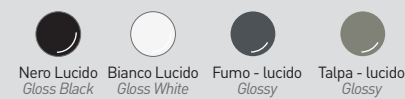

PIANO IN MARMO / MARBLE TOP

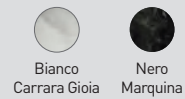

MOBILE IN LEGNO / WOODEN CABINET

laccature / lacquers

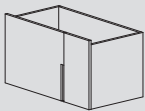

Le Terre di Cielo



FIC90LV / FIC90LVSF
FIC90EV / FIC90EVSF

Le Acque di Cielo



essenze / wooden finishes

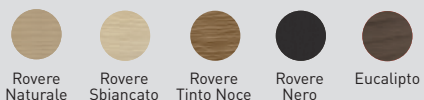

note tecniche lavabo / washbasin technical notes

con troppopieno
with overflow

senza foro
without hole

installazione sottopiano
fitted installation

con un lato non smaltato
one side is unglazed

Modulo Ordine Filo mobile con cassetto - maniglia verticale

Filo cabinet with drawer, with vertical handle Order Form

cielo

CLIENTE/client: ORD. REF.:

QUANTITA'/quantity: EMAIL:

INDICARE CON UN SEGNO LE FINITURE SCELTE PER I DIVERSI COMPONENTI

INDICATE WITH A TICK, THE CHOOSEN FINISHES FOR ALL THE COMPONENTS

art. **FILASPR58**

FINITURE LAVABO
TOP FINISHES

Essential Colors

- Bianco/white - glossy
- N - Nero/black - glossy
- FU - Fumo - glossy
- TP - Talpa - glossy

Le Terre di Cielo

<input type="radio"/> TL - Talco	<input type="radio"/> AN - Arenaria
<input type="radio"/> PM - Pomice	<input type="radio"/> AV - Avena
<input type="radio"/> BR - Brina	<input type="radio"/> LN - Lino
<input type="radio"/> BA - Basalto	<input type="radio"/> AG - Agave
<input type="radio"/> LV - Lavagna	<input type="radio"/> MU - Muschio
<input type="radio"/> CM - Cemento	<input type="radio"/> PL - Polvere
<input type="radio"/> FN - Fango	<input type="radio"/> CP - Cipria
<input type="radio"/> CA - Cacao	<input type="radio"/> CN - Canapa

Le Acque di Cielo

<input type="radio"/> OL - Oltremare	<input type="radio"/> CO - Corallo
<input type="radio"/> SM - Smeraldo	<input type="radio"/> NI - Ninfea
<input type="radio"/> AL - Alga	<input type="radio"/> AM - Anemone

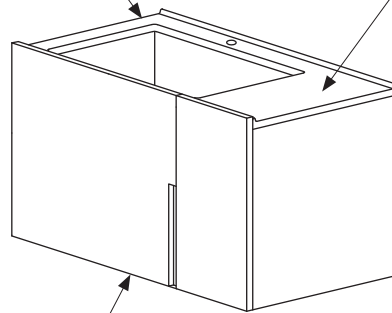

art. **FIP90**
art. **FIP90SX**
art. **FIP90DX**

FINITURE PIANO IN CERAMICA
CERAMIC TOP FINISHES

Essential Colors

- Bianco/white - glossy
- N - Nero/black - glossy
- FU - Fumo - glossy
- TP - Talpa - glossy

Le Terre di Cielo

<input type="radio"/> TL - Talco	<input type="radio"/> AN - Arenaria
<input type="radio"/> PM - Pomice	<input type="radio"/> AV - Avena
<input type="radio"/> BR - Brina	<input type="radio"/> LN - Lino
<input type="radio"/> BA - Basalto	<input type="radio"/> AG - Agave
<input type="radio"/> LV - Lavagna	<input type="radio"/> MU - Muschio
<input type="radio"/> CM - Cemento	<input type="radio"/> PL - Polvere
<input type="radio"/> FN - Fango	<input type="radio"/> CP - Cipria
<input type="radio"/> CA - Cacao	<input type="radio"/> CN - Canapa

Le Acque di Cielo

<input type="radio"/> OL - Oltremare	<input type="radio"/> CO - Corallo
<input type="radio"/> SM - Smeraldo	<input type="radio"/> NI - Ninfea
<input type="radio"/> AL - Alga	<input type="radio"/> AM - Anemone

art. **FIC90LV** (laccato/laquered)
art. **FIC90LVSF** (laccato senza scasso/laquered without hole)
art. **FIC90EV** (essenza/essence)
art. **FIC90EVSF** (essenza senza scasso/essence without hole)

FINITURE MOBILE IN LEGNO VERSIONE LISCIA
WOODEN CABINET FINISHES - SMOOTH VERSION

laccature/laquerings

<input type="radio"/> TL - Talco	Le Acque di Cielo	<input type="radio"/> RO - Rovere Nero
<input type="radio"/> PM - Pomice	<input type="radio"/> OL - Oltremare	<input type="radio"/> RT - Rovere Tinto Noce
<input type="radio"/> BR - Brina	<input type="radio"/> SM - Smeraldo	<input type="radio"/> RS - Rovere Sbiancato
<input type="radio"/> AN - Arenaria	<input type="radio"/> AL - Alga	<input type="radio"/> RN - Rovere Naturale
<input type="radio"/> AV - Avena	<input type="radio"/> CO - Corallo	<input type="radio"/> EU - Eucalipto
<input type="radio"/> CM - Cemento	<input type="radio"/> NI - Ninfea	
<input type="radio"/> BA - Basalto	<input type="radio"/> AM - Anemone	
<input type="radio"/> MU - Muschio	<input type="radio"/> FU - Fumo - glossy	
<input type="radio"/> AG - Agave	<input type="radio"/> TP - Talpa - glossy	

essenze legno/
wood essences

art. **FIP90M**
art. **FIP90MSX**
art. **FIP90MDX**

FINITURE PIANO IN MARMO
MARBLE TOP FINISHES

- MB - Bianco Carrara Gioia
- MN - Nero Marquinia

N.B. Indicare obbligatoriamente la posizione
It is mandatory to specify the position



LAVABO A SINISTRA
LEFT WASHBASIN



LAVABO A DESTRA
RIGHT WASHBASIN

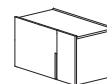

SENZA LAVABO
WITHOUT WASHBASIN

DATA

DATE

FIRMA DEL CLIENTE
SIGNATURE

ATTENZIONE:
La rappresentazione delle finiture è puramente indicativa. Verificare le finiture con le relative cartelle.
Ogni oggetto possiede la peculiarità di essere elaborato secondo principi puramente tradizionali, in modo da garantirne l'assoluta originalità ed unicità. Le eventuali piccole variazioni di colore, tono o venature fra gli articoli sono da considerarsi pregi e non difetti, in quanto garanzia della fattura manuale del prodotto, che fa di ogni oggetto Cielo un pezzo unico ed esclusivo, lontano dall'omologazione industriale. In fase d'ordine si intendono, pertanto, accettate tali tolleranze che non possono dare adito a contestazioni di alcun genere.
Verificare sempre le disponibilità e i tempi di consegna con il commerciale.

ATTENTION:
The representation of the finishes is merely indicative. Please choose the finishes using the folders.
Every item possesses that particular feature of being processed according to purely traditional principles that guarantee its absolute originality and uniqueness. The small variations in colour, hues or streaks on the items are to be considered as qualities and not defects, since they warranty the handcrafted processing which makes each Cielo item a unique and exclusive piece that cannot be compared to industrial standardization. When making the order, the client implicitly accepts those various features that may give rise to claims of any sort.
Always check the availability and delivery time with the commercial department.

modelli disponibili / available models

FILO
collection

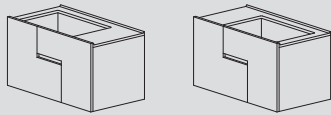

Mobile Filo 90 con maniglia orizzontale
Filo cabinet 90 with horizontal handle



finiture / finishes

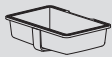

FILASPR58

LAVABO IN CERAMICA / CERAMIC WASHBASIN

Le Terre di Cielo

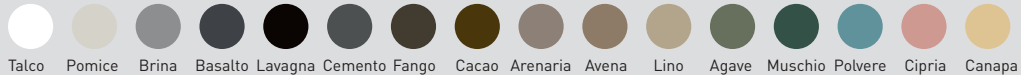

Le Acque di Cielo



Essential colors

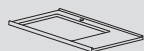
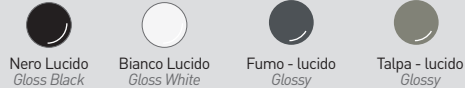

FIP90SX (ceramic)
FIP90MSX (marble)

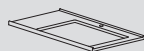

FIP90DX (ceramic)
FIP90MDX (marble)

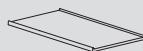

FIP90 (ceramic)
FIP90M (marble)

PIANO IN CERAMICA / CERAMIC TOP

Le Terre di Cielo

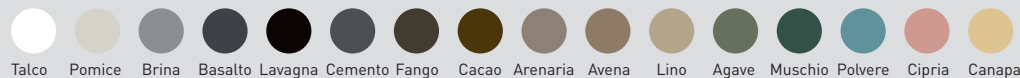

PIANO IN CERAMICA / CERAMIC TOP

Le Acque di Cielo



Essential colors

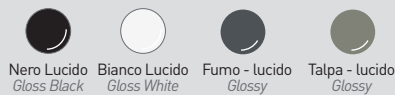

PIANO IN MARMO / MARBLE TOP

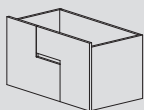
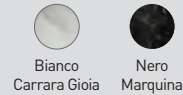

MOBILE IN LEGNO / WOODEN CABINET

laccature / lacquers

Le Terre di Cielo

FIC90LO / FIC90LOSF
FIC90EO / FIC90EOSF

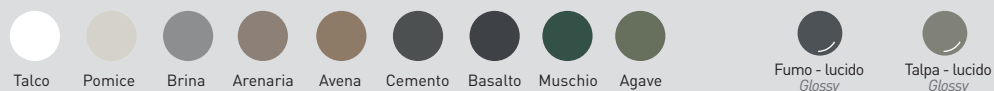

Le Acque di Cielo



essenze / wooden finishes

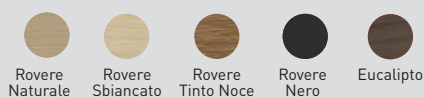

note tecniche lavabo / washbasin technical notes

con troppopieno
with overflow

senza foro
without hole

installazione sottopiano
fitted installation

con un lato non smaltato
one side is unglazed

Modulo Ordine Filo mobile con cassetto - maniglia orizzontale

Filo cabinet with drawer, with horizontal handle Order Form

cielo

CLIENTE/client: ORD. REF.:

QUANTITA'/quantity: EMAIL:

INDICARE CON UN SEGNO LE FINITURE SCELTE PER I DIVERSI COMPONENTI

INDICATE WITH A TICK, THE CHOSEN FINISHES FOR ALL THE COMPONENTS

art. **FILASPR58**

FINITURE LAVABO

TOP FINISHES

Essential Colors

- Bianco/white - glossy
- N - Nero/black - glossy
- FU - Fumo - glossy
- TP - Talpa - glossy

Le Terre di Cielo

- | | |
|------------------------------------|-------------------------------------|
| <input type="radio"/> TL - Talco | <input type="radio"/> AN - Arenaria |
| <input type="radio"/> PM - Pomice | <input type="radio"/> AV - Avena |
| <input type="radio"/> BR - Brina | <input type="radio"/> LN - Lino |
| <input type="radio"/> BA - Basalto | <input type="radio"/> AG - Agave |
| <input type="radio"/> LV - Lavagna | <input type="radio"/> MU - Muschio |
| <input type="radio"/> CM - Cemento | <input type="radio"/> PL - Polvere |
| <input type="radio"/> FN - Fango | <input type="radio"/> CP - Cipria |
| <input type="radio"/> CA - Cacao | <input type="radio"/> CN - Canapa |

Le Acque di Cielo

- | | |
|--------------------------------------|------------------------------------|
| <input type="radio"/> OL - Oltremare | <input type="radio"/> CO - Corallo |
| <input type="radio"/> SM - Smeraldo | <input type="radio"/> NI - Ninfea |
| <input type="radio"/> AL - Alga | <input type="radio"/> AM - Anemone |

art. **FIP90**

art. **FIP90SX**

art. **FIP90DX**

FINITURE PIANO IN CERAMICA

CERAMIC TOP FINISHES

Essential Colors

- Bianco/white - glossy
- N - Nero/black - glossy
- FU - Fumo - glossy
- TP - Talpa - glossy

Le Terre di Cielo

- | | |
|------------------------------------|-------------------------------------|
| <input type="radio"/> TL - Talco | <input type="radio"/> AN - Arenaria |
| <input type="radio"/> PM - Pomice | <input type="radio"/> AV - Avena |
| <input type="radio"/> BR - Brina | <input type="radio"/> LN - Lino |
| <input type="radio"/> BA - Basalto | <input type="radio"/> AG - Agave |
| <input type="radio"/> LV - Lavagna | <input type="radio"/> MU - Muschio |
| <input type="radio"/> CM - Cemento | <input type="radio"/> PL - Polvere |
| <input type="radio"/> FN - Fango | <input type="radio"/> CP - Cipria |
| <input type="radio"/> CA - Cacao | <input type="radio"/> CN - Canapa |

Le Acque di Cielo

- | | |
|--------------------------------------|------------------------------------|
| <input type="radio"/> OL - Oltremare | <input type="radio"/> CO - Corallo |
| <input type="radio"/> SM - Smeraldo | <input type="radio"/> NI - Ninfea |
| <input type="radio"/> AL - Alga | <input type="radio"/> AM - Anemone |

art. **FIC90LO** (laccato/laquered)

art. **FIC90LOSF** (laccato senza scasso/laquered without hole)

art. **FIC90EO** (essenza/essence)

art. **FIC90EOSF** (essenza senza scasso/essence without hole)

FINITURE MOBILE IN LEGNO VERSIONE LISCIA

WOODEN CABINET FINISHES - SMOOTH VERSION

laccature/laquerings

- | | |
|-------------------------------------|---|
| <input type="radio"/> TL - Talco | <input type="radio"/> OL - Oltremare |
| <input type="radio"/> PM - Pomice | <input type="radio"/> SM - Smeraldo |
| <input type="radio"/> BR - Brina | <input type="radio"/> AL - Alga |
| <input type="radio"/> AN - Arenaria | <input type="radio"/> CO - Corallo |
| <input type="radio"/> AV - Avena | <input type="radio"/> NI - Ninfea |
| <input type="radio"/> CM - Cemento | <input type="radio"/> AM - Anemone |
| <input type="radio"/> BA - Basalto | <input type="radio"/> FU - Fumo - glossy |
| <input type="radio"/> MU - Muschio | <input type="radio"/> TP - Talpa - glossy |
| <input type="radio"/> AG - Agave | |

essenze legno/
wood essences

- RO - Rovere Nero
- RT - Rovere Tinto Noce
- RS - Rovere Sbiancato
- RN - Rovere Naturale
- EU - Eucalipto

art. **FIP90M**

art. **FIP90MSX**

art. **FIP90MDX**

FINITURE PIANO IN MARMO

MARBLE TOP FINISHES

- MB - Bianco Carrara Gioia
- MN - Nero Marquinia

N.B. Indicare obbligatoriamente la posizione
It is mandatory to specify the position

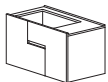

LAVABO A SINISTRA
LEFT WASHBASIN

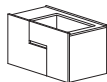

LAVABO A DESTRA
RIGHT WASHBASIN

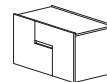

SENZA LAVABO
WITHOUT WASHBASIN

DATA

DATE

FIRMA DEL CLIENTE
SIGNATURE

ATTENZIONE:

La rappresentazione delle finiture è puramente indicativa. Verificare le finiture con le relative cartelle. Ogni oggetto possiede la peculiarità di essere elaborato secondo principi puramente tradizionali, in modo da garantirne l'assoluta originalità ed unicità. Le eventuali piccole variazioni di colore, tono o venature fra gli articoli sono da considerarsi pregi e non difetti, in quanto garanzia della fattura manuale del prodotto, che fa di ogni oggetto Cielo un pezzo unico ed esclusivo, lontano dall'omologazione industriale. In fase d'ordine si intendono, pertanto, accettate tali tolleranze che non possono dare adito a contestazioni di alcun genere. Verificare sempre le disponibilità e i tempi di consegna con il commerciale.

ATTENTION:

The representation of the finishes is merely indicative. Please choose the finishes using the folders. Every item possesses that particular feature of being processed according to purely traditional principles that guarantee its absolute originality and uniqueness. The small variations in colour, hues or streaks on the items are to be considered as qualities and not defects, since they warranty the handcrafted processing which makes each Cielo item a unique and exclusive piece that cannot be compared to industrial standardization. When making the order, the client implicitly accepts those various features that may give rise to claims of any sort. Always check the availability and delivery time with the commercial department.

modelli disponibili / available models

FILO
collection

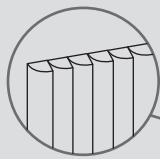

DETTAGLIO DOGHE IN LEGNO
STRIPS WOODEN DETAIL

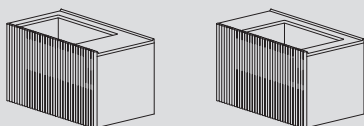

Mobile Filo 90 con frontale a doghe
Filo cabinet 90 with wooden strips

finiture / finishes



FILASPR58

LAVABO IN CERAMICA / CERAMIC WASHBASIN

Le Terre di Cielo

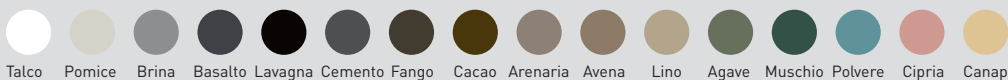

Le Acque di Cielo



Essential colors

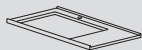

FIP90SX (ceramic)
FIP90MSX (marble)

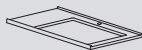

FIP90DX (ceramic)
FIP90MDX (marble)

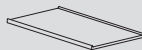

FIP90 (ceramic)
FIP90M (marble)

PIANO IN CERAMICA / CERAMIC TOP

Le Terre di Cielo



PIANO IN CERAMICA / CERAMIC TOP

Le Acque di Cielo



Essential colors

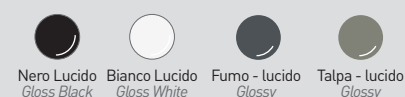

PIANO IN MARMO / MARBLE TOP

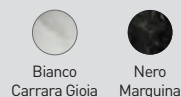

MOBILE IN LEGNO / WOODEN CABINET

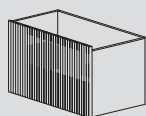

FIC90E / FIC90ESF

essenze / wooden finishes

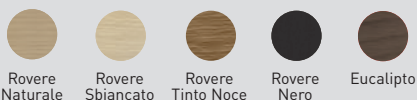

note tecniche lavabo / washbasin technical notes



con troppopieno
with overflow



senza foro
without hole



installazione sottopiano
fitted installation



con un lato non smaltato
one side is unglazed

Modulo Ordine Filo mobile con cassetto - frontale a doghe

Filo cabinet with drawer, wooden strips Order Form

cielo

CLIENTE/client: ORD. REF.:

QUANTITA'/quantity: EMAIL:

INDICARE CON UN SEGNO LE FINITURE SCELTE PER I DIVERSI COMPONENTI

INDICATE WITH A TICK, THE CHOSEN FINISHES FOR ALL THE COMPONENTS

art. **FILASPR58**

FINITURE LAVABO

TOP FINISHES

Essential Colors

- Bianco/white - glossy
- N - Nero/black - glossy
- FU - Fumo - glossy
- TP - Talpa - glossy

Le Terre di Cielo

- | | |
|------------------------------------|-------------------------------------|
| <input type="radio"/> TL - Talco | <input type="radio"/> AN - Arenaria |
| <input type="radio"/> PM - Pomice | <input type="radio"/> AV - Avena |
| <input type="radio"/> BR - Brina | <input type="radio"/> LN - Lino |
| <input type="radio"/> BA - Basalto | <input type="radio"/> AG - Agave |
| <input type="radio"/> LV - Lavagna | <input type="radio"/> MU - Muschio |
| <input type="radio"/> CM - Cemento | <input type="radio"/> PL - Polvere |
| <input type="radio"/> FN - Fango | <input type="radio"/> CP - Cipria |
| <input type="radio"/> CA - Cacao | <input type="radio"/> CN - Canapa |

Le Acque di Cielo

- | | |
|--------------------------------------|------------------------------------|
| <input type="radio"/> OL - Oltremare | <input type="radio"/> CO - Corallo |
| <input type="radio"/> SM - Smeraldo | <input type="radio"/> NI - Ninfea |
| <input type="radio"/> AL - Alga | <input type="radio"/> AM - Anemone |

art. **FIP90**

art. **FIP90SX**

art. **FIP90DX**

FINITURE PIANO IN CERAMICA

CERAMIC TOP FINISHES

Essential Colors

- Bianco/white - glossy
- N - Nero/black - glossy
- FU - Fumo - glossy
- TP - Talpa - glossy

Le Terre di Cielo

- | | |
|------------------------------------|-------------------------------------|
| <input type="radio"/> TL - Talco | <input type="radio"/> AN - Arenaria |
| <input type="radio"/> PM - Pomice | <input type="radio"/> AV - Avena |
| <input type="radio"/> BR - Brina | <input type="radio"/> LN - Lino |
| <input type="radio"/> BA - Basalto | <input type="radio"/> AG - Agave |
| <input type="radio"/> LV - Lavagna | <input type="radio"/> MU - Muschio |
| <input type="radio"/> CM - Cemento | <input type="radio"/> PL - Polvere |
| <input type="radio"/> FN - Fango | <input type="radio"/> CP - Cipria |
| <input type="radio"/> CA - Cacao | <input type="radio"/> CN - Canapa |

Le Acque di Cielo

- | | |
|--------------------------------------|------------------------------------|
| <input type="radio"/> OL - Oltremare | <input type="radio"/> CO - Corallo |
| <input type="radio"/> SM - Smeraldo | <input type="radio"/> NI - Ninfea |
| <input type="radio"/> AL - Alga | <input type="radio"/> AM - Anemone |

art. **FIC90E**

art. **FIC90ESF** (senza scasso/without hole)

FINITURE MOBILE IN LEGNO

WOODEN CABINET FINISHES

essenze legno/
wood essences

- RO - Rovere Nero
- RT - Rovere Tinto Noce
- RS - Rovere Sbiancato
- RN - Rovere Naturale
- EU - Eucalipto

art. **FIP90M**

art. **FIP90MSX**

art. **FIP90MDX**

FINITURE PIANO IN MARMO

MARBLE TOP FINISHES

- MB - Bianco Carrara Gioia
- MN - Nero Marquinia

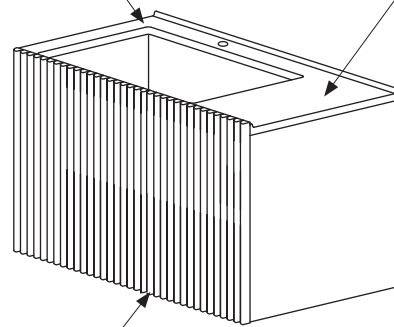

N.B. Indicare obbligatoriamente la posizione
It is mandatory to specify the position

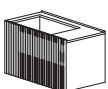

LAVABO A SINISTRA
LEFT WASHBASIN

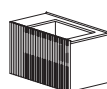

LAVABO A DESTRA
RIGHT WASHBASIN

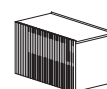

SENZA LAVABO
WITHOUT WASHBASIN

DATA

DATE

FIRMA DEL CLIENTE
SIGNATURE

ATTENZIONE:

La rappresentazione delle finiture è puramente indicativa. Verificare le finiture con le relative cartelle. Ogni oggetto possiede la peculiarità di essere elaborato secondo principi puramente tradizionali, in modo da garantirne l'assoluta originalità ed unicità. Le eventuali piccole variazioni di colore, tono o venature fra gli articoli sono da considerarsi pregi e non difetti, in quanto garanzia della fattura manuale del prodotto, che fa di ogni oggetto Cielo un pezzo unico ed esclusivo, lontano dall'omologazione industriale. In fase d'ordine si intendono, pertanto, accettate tali tolleranze che non possono dare adito a contestazioni di alcun genere. Verificare sempre le disponibilità e i tempi di consegna con il commerciale.

ATTENTION:

The representation of the finishes is merely indicative. Please choose the finishes using the folders. Every item possesses that particular feature of being processed according to purely traditional principles that guarantee its absolute originality and uniqueness. The small variations in colour, hues or streaks on the items are to be considered as qualities and not defects, since they warranty the handcrafted processing which makes each Cielo item a unique and exclusive piece that cannot be compared to industrial standardization. When making the order, the client implicitly accepts those various features that may give rise to claims of any sort. Always check the availability and delivery time with the commercial department.

modelli disponibili / available models

FILO
collection

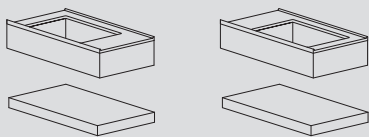

Lavabo con mensola
Washbasin with shelf



finiture / finishes



FILASPR58

LAVABO IN CERAMICA / CERAMIC WASHBASIN

Le Terre di Cielo

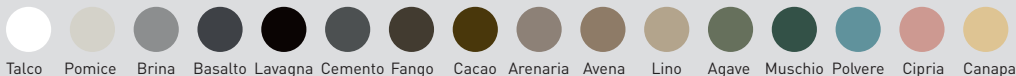

Le Acque di Cielo



Essential colors

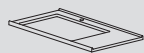

FIP90SX (ceramic)
FIP90MSX (marble)

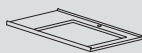

FIP90DX (ceramic)
FIP90MDX (marble)

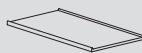

FIP90 (ceramic)
FIP90M (marble)

PIANO IN CERAMICA / CERAMIC TOP

Le Terre di Cielo

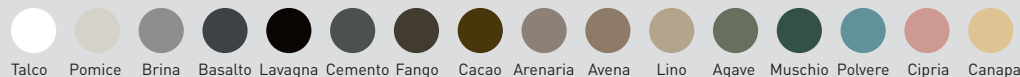

PIANO IN CERAMICA / CERAMIC TOP

Le Acque di Cielo



Essential colors

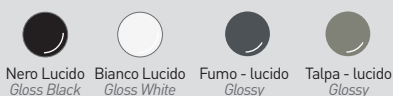

PIANO IN MARMO / MARBLE TOP

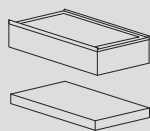
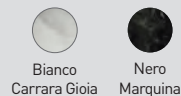

FIB90L / FIB90E
FIM90L / FIM90E

BASE LAVABO E MENSOLA IN LEGNO / WOODEN BASE UNIT AND SHELF

laccature / lacquers

Le Terre di Cielo



Le Acque di Cielo



essenze / wooden finishes

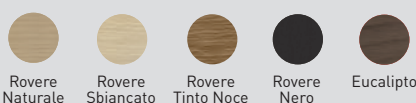

note tecniche lavabo / washbasin technical notes



con troppopieno
with overflow



senza foro
without hole



installazione sottopiano
fitted installation



con un lato non smaltato
one side is unglazed

Modulo Ordine Filo lavabo con mensola

Filo washbasin with shelf Order Form

cielo

CLIENTE/client: ORD. REF.:

QUANTITA'/quantity: EMAIL:

INDICARE CON UN SEGNO LE FINITURE SCELTE PER I DIVERSI COMPONENTI

INDICATE WITH A TICK, THE CHOSEN FINISHES FOR ALL THE COMPONENTS

art. **FILASPR58**

FINITURE LAVABO

TOP FINISHES

Essential Colors

- Bianco/white - glossy
- N - Nero/black - glossy
- FU - Fumo - glossy
- TP - Talpa - glossy

Le Terre di Cielo

- | | |
|------------------------------------|-------------------------------------|
| <input type="radio"/> TL - Talco | <input type="radio"/> AN - Arenaria |
| <input type="radio"/> PM - Pomice | <input type="radio"/> AV - Avena |
| <input type="radio"/> BR - Brina | <input type="radio"/> LN - Lino |
| <input type="radio"/> BA - Basalto | <input type="radio"/> AG - Agave |
| <input type="radio"/> LV - Lavagna | <input type="radio"/> MU - Muschio |
| <input type="radio"/> CM - Cemento | <input type="radio"/> PL - Polvere |
| <input type="radio"/> FN - Fango | <input type="radio"/> CP - Cipria |
| <input type="radio"/> CA - Cacao | <input type="radio"/> CN - Canapa |

Le Acque di Cielo

- | | |
|--------------------------------------|------------------------------------|
| <input type="radio"/> OL - Oltremare | <input type="radio"/> CO - Corallo |
| <input type="radio"/> SM - Smeraldo | <input type="radio"/> NI - Ninfea |
| <input type="radio"/> AL - Alga | <input type="radio"/> AM - Anemone |

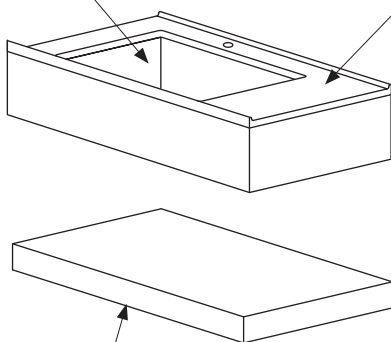

art. **FIP90**

art. **FIP90SX**

art. **FIP90DX**

FINITURE PIANO IN CERAMICA

CERAMIC TOP FINISHES

Essential Colors

- Bianco/white - glossy
- N - Nero/black - glossy
- FU - Fumo - glossy
- TP - Talpa - glossy

Le Terre di Cielo

- | | |
|------------------------------------|-------------------------------------|
| <input type="radio"/> TL - Talco | <input type="radio"/> AN - Arenaria |
| <input type="radio"/> PM - Pomice | <input type="radio"/> AV - Avena |
| <input type="radio"/> BR - Brina | <input type="radio"/> LN - Lino |
| <input type="radio"/> BA - Basalto | <input type="radio"/> AG - Agave |
| <input type="radio"/> LV - Lavagna | <input type="radio"/> MU - Muschio |
| <input type="radio"/> CM - Cemento | <input type="radio"/> PL - Polvere |
| <input type="radio"/> FN - Fango | <input type="radio"/> CP - Cipria |
| <input type="radio"/> CA - Cacao | <input type="radio"/> CN - Canapa |

Le Acque di Cielo

- | | |
|--------------------------------------|------------------------------------|
| <input type="radio"/> OL - Oltremare | <input type="radio"/> CO - Corallo |
| <input type="radio"/> SM - Smeraldo | <input type="radio"/> NI - Ninfea |
| <input type="radio"/> AL - Alga | <input type="radio"/> AM - Anemone |

art. **FIB90L** (laccato/laquered) / art. **FIB90LSF** (laccato senza scasso/laquered without hole)

art. **FIB90E** (essenza/essence) / art. **FIB90ESF** (essenza senza scasso/essence without hole)

art. **FIM90L** (laccato/laquered) / art. **FIM90E**

FINITURE BASE LAVABO E MENSOLA

BASE WASHBASIN AND SHELF FINISHES

laccature/laquerings

- | | |
|-------------------------------------|---|
| <input type="radio"/> TL - Talco | Le Acque di Cielo |
| <input type="radio"/> PM - Pomice | <input type="radio"/> OL - Oltremare |
| <input type="radio"/> BR - Brina | <input type="radio"/> SM - Smeraldo |
| <input type="radio"/> AN - Arenaria | <input type="radio"/> AL - Alga |
| <input type="radio"/> AV - Avena | <input type="radio"/> CO - Corallo |
| <input type="radio"/> CM - Cemento | <input type="radio"/> NI - Ninfea |
| <input type="radio"/> BA - Basalto | <input type="radio"/> AM - Anemone |
| <input type="radio"/> MU - Muschio | <input type="radio"/> FU - Fumo - glossy |
| <input type="radio"/> AG - Agave | <input type="radio"/> TP - Talpa - glossy |

essenze legno/
wood essences

- RO - Rovere Nero
- RT - Rovere Tinto Noce
- RS - Rovere Sbiancato
- RN - Rovere Naturale
- EU - Eucalipto

art. **FIP90M**

art. **FIP90MSX**

art. **FIP90MDX**

FINITURE PIANO IN MARMO

MARBLE TOP FINISHES

- MB - Bianco Carrara Gioia
- MN - Nero Marquinia

N.B. Indicare obbligatoriamente la posizione
It is mandatory to specify the position

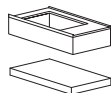

LAVABO A SINISTRA
LEFT WASHBASIN

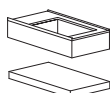

LAVABO A DESTRA
RIGHT WASHBASIN

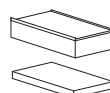

SENZA LAVABO
WITHOUT WASHBASIN

DATA

DATE

FIRMA DEL CLIENTE
SIGNATURE







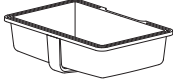

ATTENZIONE:

La rappresentazione delle finiture è puramente indicativa. Verificare le finiture con le relative cartelle. Ogni oggetto possiede la peculiarità di essere elaborato secondo principi puramente tradizionali, in modo da garantirne l'assoluta originalità ed unicità. Le eventuali piccole variazioni di colore, tono o venature fra gli articoli sono da considerarsi pregi e non difetti, in quanto garanzia della fattura manuale del prodotto, che fa di ogni oggetto Cielo un pezzo unico ed esclusivo, lontano dall'omologazione industriale. In fase d'ordine si intendono, pertanto, accettate tali tolleranze che non possono dare adito a contestazioni di alcun genere. Verificare sempre le disponibilità e i tempi di consegna con il commerciale.

ATTENTION:

The representation of the finishes is merely indicative. Please choose the finishes using the folders. Every item possesses that particular feature of being processed according to purely traditional principles that guarantee its absolute originality and uniqueness. The small variations in colour, hues or streaks on the items are to be considered as qualities and not defects, since they warranty the handcrafted processing which makes each Cielo item a unique and exclusive piece that cannot be compared to industrial standardization. When making the order, the client implicitly accepts those various features that may give rise to claims of any sort. Always check the availability and delivery time with the commercial department.





































Washbasin_lavabo_Waschbecken_раковиной Консоли с раковиной





















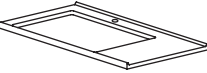









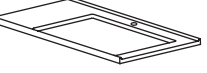





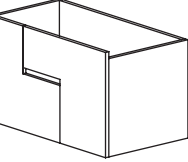

	Size (cm) Medidas Dimensions Maße Размеры	Product code Artículo Article Artikel Артикул	Net weight (Kg) Peso neto Poids net Reingewicht вес нетто	Finishes Acabados Finitions Farbe Отделки	Euro Евро	Pz. шт. pallet Italia	Pz. шт. pallet Cont.
 <p>Undercounter rectangular washbasin Lavabo bajo encimera rectangular / Vasque à encastrer par dessous rectangulaire / Rechteckiges Unterbaubecken / Раковина прямоугольная встроенная под столешницу</p>	58 x 35 x h 15	FILASPR58(x)*		<ul style="list-style-type: none">  Gloss White  *X = N - Gloss Black  *X = FU - Fumo  *X = TP - Talpa  Le Terre di Cielo  Le Acque di Cielo 	319,00		
 <p>Fixing system for undercounter washbasin Fijaciones para lavabo bajo encimera / Fixations pour vasque à encastrer par dessous / Befestigungen für Unterbaubecken / Крепления для раковины для установки под столешницу</p>		FISP	0,40		17,00		

Technical symbols legend / Simbolos técnicos clave | Légende symboles techniques | Technische Zeichenerklärung / Перечень технических символов











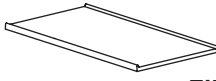



-  **with overflow**
con rebosadero
avec trop-plein
mit Überlauf
с переливом
-  **fitted installation**
instalación en encimera
installation sous plan
Unterbaumontage
встраиваемая установка

- Le Terre di Cielo
-  TL - Talco
 -  PM - Pomice
 -  BR - Brina
 -  BA - Basalto
 -  LV - Lavagna
 -  CM - Cemento
 -  FN - Fango
 -  CA - Cacao
 -  AN - Arenaria
 -  AV - Avena
 -  LN - Lino
 -  AG - Agave
 -  MU - Muschio
 -  PL - Polvere
 -  CP - Cipria
 -  CN - Canapa
- Le Acque di Cielo
-  OL - Oltremare
 -  SM - Smeraldo
 -  AL - Alga
 -  CO - Corallo
 -  NI - Ninfea
 -  AM - Anemone

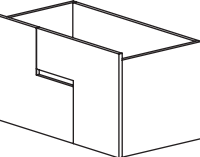
	Product code Artículo Article Artikel Артикул	Net weight (Kg) Peso neto Poids net Reingewicht вес нетто	Finishes Acabados Finitions Farbe Отделки	Euro Евро
 <p>Universal click/clack drain in CHROME with ceramic lid Válvula universal click/clack Cromado con tapa en cerámica Bonde universelle clic/clac Chromé avec clapet en céramique Universal-Ablaufgarnitur Click-Clack Chrom mit Keramikstopfen Универсальный донный клапан click/clack хром с керамической крышкой</p>	PIL01(X)*	0,40	<ul style="list-style-type: none">  Gloss White  *X = N - Gloss Black  *X = FU - Fumo  *X = TP- Talpa  Le Terre di Cielo  Le Acque di Cielo 	<p>95,00</p> <p>114,00</p> <p>139,00</p> <p>139,00</p> <p>139,00</p> <p>139,00</p>
 <p>Universal click/clack drain in BLACK MATT finish with ceramic lid / Válvula universal click/clack Negro Matt con tapa en cerámica Bonde universelle clic/clac Noir Mat avec clapet en céramique / Universal-Ablaufgarnitur Click-Clack Matt Schwarz mit Keramikstopfen / Универсальный донный клапан click/clack черный матовый с керамической крышкой</p>	PIL01NM(X)*	0,40	<ul style="list-style-type: none">  Gloss White  *X = N - Gloss Black  *X = FU - Fumo  *X = TP- Talpa  Le Terre di Cielo  Le Acque di Cielo 	<p>120,00</p> <p>159,00</p> <p>169,00</p> <p>169,00</p> <p>169,00</p> <p>169,00</p>
 <p>Universal click/clack drain in CEMENTO finish with ceramic lid / Válvula universal click/clack Cemento con tapa en cerámica Bonde universelle clic/clac Cemento avec clapet en céramique / Universal-Ablaufgarnitur Click-Clack Cement mit Keramikstopfen / Универсальный донный клапан click/clack с керамической крышкой</p>	PIL01CM(X)*	0,40	<ul style="list-style-type: none">  Gloss White  *X = N - Gloss Black  *X = FU - Fumo  *X = TP- Talpa  Le Terre di Cielo  Le Acque di Cielo 	<p>120,00</p> <p>159,00</p> <p>169,00</p> <p>169,00</p> <p>169,00</p> <p>169,00</p>
 <p>Universal click/clack drain in BRONZE with ceramic lid Válvula universal click/clack Bronce con tapa en cerámica Bonde universelle clic/clac Bronze avec clapet en céramique Universal-Ablaufgarnitur Click-Clack Bronze mit Keramikstopfen / Универсальный донный клапан click/clack бронза с керамической крышкой</p>	PIL01BR(X)*	0,40	<ul style="list-style-type: none">  Gloss White  *X = N - Gloss Black  *X = FU - Fumo  *X = TP- Talpa  Le Terre di Cielo  Le Acque di Cielo 	<p>135,00</p> <p>171,00</p> <p>182,00</p> <p>182,00</p> <p>182,00</p> <p>182,00</p>
 <p>CHROMED siphon Sifone Cromado \ Siphon Chromé \ Siphon Verchromt \ сифон Chrome</p>	SISP	0,93	<ul style="list-style-type: none">  Chrome 	133,00
 <p>MATT BLACK siphon Sifone Negro Mate \ Siphon Noir Mat \ Siphon Schwarz Matt \ Сифон Черный матовый</p>	SIFN	0,93	<ul style="list-style-type: none">  Matt Black 	194,00
 <p>CEMENTO siphon Sifone Cemento \ Siphon Cemento \ Siphon Cemento \ сифон Cemento</p>	SIFCM	0,93	<ul style="list-style-type: none">  Cemento 	194,00
 <p>BRONZE siphon Sifone Bronce \ Siphon Bronze \ Siphon Bronze \ бронза сифон</p>	SIFBR	0,93	<ul style="list-style-type: none">  Bronze 	220,00

	Size (cm)	Product code	Net weight(Kg)	Finishes	Euro	Pz.	Pz.
	Medidas Dimensions Maße Размеры	Artículo Article Artikel Артикул	Peso neto Poids net Reingewicht вес нетто	Acabados Finitions Farbe Отделки	Евро	шт. pallet Italia	шт. pallet Cont.
<p>drains and siphons pg. 19 desagües y sifones pg. 19 les drains et les siphons pg. 19 Ablaufgarnituren und Siphons pg. 19 Донные клапаны и сифоны pg. 19</p>    <p>Undercounter rectangular washbasin Lavabo bajo encimera rectangular / Vasque à encastrer par dessous rectangulaire / Rechteckiges Unterbaubecken / Раковина прямоугольная встроенная под столешницу</p>	58 x 35 x h 15	FILASPR58(X)*		<ul style="list-style-type: none">  Gloss White  *X = N - Gloss Black  *X = FU - Fumo  *X = TP - Talpa  Le Terre di Cielo  Le Acque di Cielo 	319,00 462,00 462,00 462,00 462,00 462,00		
  <p>Filo 90 ceramic countertop - left Encimera de cerámica - izquierda Plaque en céramique - gauche Regal aus keramik - links Керамическая столешница - справа</p>	90 x 53 x h3	FIP90SX(X)* FIP90SXS(X)* no tap hole sin agujero - sans orifice - ohne Loch без отверстия		<ul style="list-style-type: none">  Gloss White  *X = N - Gloss Black  *X = FU - Fumo  *X = TP - Talpa  Le Terre di Cielo  Le Acque di Cielo 	385,00 550,00 550,00 550,00 550,00		
 <p>Filo 90 marble countertop - left Encimera de mármol - izquierda Plaque en marbre - gauche Marmor Regal - links Столешница из мрамора - справа</p>		FIP90MSX(X)* FIP90MSXS(X)* no tap hole sin agujero - sans orifice - ohne Loch без отверстия		<ul style="list-style-type: none">  *X = MB - Bianco Carrara Gioia  *X = MN - Nero Marquina 	1210,00 1210,00		
  <p>Filo 90 ceramic countertop - right Encimera de cerámica - derecha Plaque en céramique - droite Regal aus keramik - rechts Керамическая столешница - слева</p>	90 x 53 x h3	FIP90DX(X)* FIP90DXS(X)* no tap hole sin agujero - sans orifice - ohne Loch без отверстия		<ul style="list-style-type: none">  Gloss White  *X = N - Gloss Black  *X = FU - Fumo  *X = TP - Talpa  Le Terre di Cielo  Le Acque di Cielo 	385,00 550,00 550,00 550,00 550,00		
 <p>Filo 90 marble countertop - right Encimera de mármol - derecha Plaque en marbre - droite Marmor Regal - rechts Столешница из мрамора - слева</p>		FIP90MDX(X)* FIP90MDXS(X)* no tap hole sin agujero - sans orifice - ohne Loch без отверстия		<ul style="list-style-type: none">  *X = MB - Bianco Carrara Gioia  *X = MN - Nero Marquina 	1210,00 1210,00		
  <p>Filo 90 lacquered cabinet with drawer - horizontal handle Mueble lacado Filo 90, con cajón - tirador horizontal \ Meuble laqué Filo 90, avec tiroir - poignée horizontale \ Möbel Filo 90 lackiert, mit Schublade - Griff horizontal \ Мебель Filo 90 в крашенной отделке, с ящиком - горизонтальная ручка</p>	90 x 55 x h 45	FIC90LO(X)*		<ul style="list-style-type: none">  *X = FU - Fumo  *X = TP - Talpa  Le Terre di Cielo*  Le Acque di Cielo 	1887,00 1887,00 1733,00 1887,00		
 <p>Filo 90 cabinet in wood with drawer - horizontal handle Mueble Filo 90 de madera, con cajón - tirador horizontal \ Meuble Filo 90 en bois, avec tiroir - poignée horizontale \ Möbel Filo 90 aus Holz, mit Schublade - Griff horizontal \ Мебель Filo 90 в отделке из шпона, с ящиком - горизонтальная ручка</p>		FIC90EO(X)*		<ul style="list-style-type: none">  EsSENze ROvere •  *X = EU - Eucalipto 	2145,00 2420,00		

 **ATTENTION: Compulsory washbasin + countertop + cabinet. The washbasin can also be purchased individually.**
ATENCIÓN: composición obligatoria lavabo + encimera + mueble. El lavabo también se puede adquirir individualmente.
ATTENTION: composition vasque + plan/top + meuble obligatoire. La vasque peut également être achetée individuellement.
ACHTUNG: Verpflichtung zum Kauf von Waschbecken + Arbeitsplatte + Unterschrank. Das Waschbecken kann auch einzeln gekauft werden.
ВНИМАНИЕ: Обязательный набор: тумбочка + столешница + мебель. Раковина может быть приобретением отдельно.

	Size (cm) Medidas Dimensions Maße Размеры	Product code Artículo Article Artikel Артикул	Net weight (Kg) Peso neto Poids net Reingewicht вес нетто	Finishes Acabados Finitions Farbe Отделки	Euro Евро	Pz. шт. pallet Italia	Pz. шт. pallet Cont.
<p>Filo 90 ceramic countertop, without washbasin Encimera de cerámica Plaque en céramique Regal aus Keramik Керамическая столешница</p> 	90 x 53 x h3	FIP90(X)*		<ul style="list-style-type: none">  Gloss White  *X = N - Gloss Black  *X = FU - Fumo  *X = TP - Talpa  Le Terre di Cielo  Le Acque di Cielo 	341,00		
		FIP90M(X)*		<ul style="list-style-type: none">  *X = MB - Bianco Carrara Gioia  *X = MN - Nero Marquina 	506,00	506,00	506,00
<p>Filo 90 lacquered cabinet with drawer – horizontal handle version without washbasin Mueble lacado Filo 90, con cajón - versión tirador horizontal sin lavabo \ Meuble laqué Filo 90, avec tiroir - version poignée horizontale sans vasque \ Möbel Filo 90 lackiert, mit Schublade - Griff horizontal, Ausführung ohne Waschbecken \ Мебель Filo 90 в крашенной отделке, с ящиком - горизонтальная ручка, версия без раковины</p> 	90 x 55 x h 45	FIC90LOSF(X)*		<ul style="list-style-type: none">  *X = FU - Fumo  *X = TP - Talpa  Le Terre di Cielo*  Le Acque di Cielo 	1887,00		
		FIC90EOSF(X)*		<ul style="list-style-type: none">  EsSENze Rovere •  *X = EU - Eucalipto 	1887,00	1733,00	1887,00
<p>Filo 90 cabinet in wood with drawer – horizontal handle version without washbasin Mueble Filo 90 de madera, con cajón - versión tirador horizontal sin lavabo \ Meuble Filo 90 en bois, avec tiroir - version poignée horizontale sans vasque \ Möbel Filo 90 aus Holz, mit Schublade - Griff horizontal, Ausführung ohne Waschbecken \ Мебель Filo 90 в отделке из шпона, с ящиком - горизонтальная ручка, версия без раковины</p>							

Technical symbols legend / Símbolos técnicos clave / Légende symboles techniques / Technische Zeichenerklärung / Перечень технических символов









with overflow
con rebosadero
avec trop-plein
mit Überlauf
с переливом

fitted installation
instalación en encimera
Installation sous plan
Unterbaumontage
встраиваемая установка

one tap hole
con 1 agujero
monotrou
1-Loch
одно отверстие
под смеситель



no tap hole on request
sin agujero, solo a petición
sans orifice sur demande
auf Anfrage ohne Loch
без отверстия под смеситель по запросу

Mandatory composition: FIP90/FIP90M + FIC90LOSF/FIC90EOSF
Composición obligatoria: FIP90/FIP90M + FIC90LOSF/FIC90EOSF
Composition obligatoire: FIP90/FIP90M + FIC90LOSF/FIC90EOSF
Das Möbel besteht obligatorisch aus: FIP90/FIP90M + FIC90LOSF/FIC90EOSF
Обязательный комплект: FIP90/FIP90M + FIC90LOSF/FIC90EOSF

Le Terre di Cielo  TL - Talco  PM - Pomice  BR - Brina  BA - Basalto  LV - Lavagna  CM - Cemento  FN - Fango  CA - Cacao

 AN - Arenaria  AV - Avena  LN - Lino  AG - Agave  MU - Muschio  PL - Polvere  CP - Cipria  CN - Canapa

Le Acque di Cielo  OL - Oltremare  SM - Smeraldo  AL - Alga  CO - Corallo  NI - Ninfea  AM - Anemone

















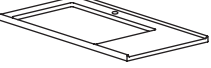





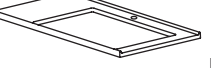







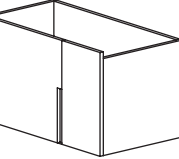

• **EsSENze Rovere**  RS - Rovere Sbiancato  RN - Rovere Naturale  RN - Rovere Nero  RT - Rovere Tinto Noce

* **Terre/Acque di Cielo laquering available for cabinet**
/ lacados Terre/Acque di Cielo disponibles para mueble /
laquages Terre/Acque di Cielo disponibles pour le meuble /
Für Möbel erhältliche Lackierungen Terre/Acque di Cielo /
крашная отделка Terre/Acque di Cielo доступна для
ящика и столешницы











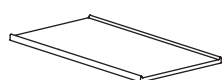





 TL - Talco  PM - Pomice  BR - Brina  AN - Arenaria  AV - Avena

 CM - Cemento  BA - Basalto  MU - Muschio  AG - Agave

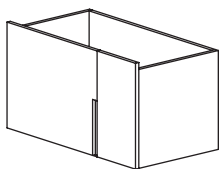

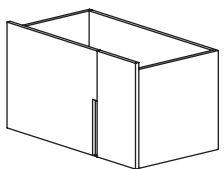

 OL - Oltremare  SM - Smeraldo  AL - Alga  CO - Corallo  NI - Ninfea  AM - Anemone

<p>drains and siphons pg. 19 desagües y sifones pg. 19 les drains et les siphons pg. 19 Ablaufgarnituren und Siphons pg. 19 Донные клапаны и сифоны pg. 19</p>	<p>Size (cm) Medidas Dimensions Maße Размеры</p>	<p>Product code Artículo Article Artikel Артикул</p>	<p>Net weight(Kg) Peso neto Poids net Reingewicht вес нетто</p>	<p>Finishes Acabados Finitions Farbe Отделки</p>	<p>Euro Евро</p>	<p>Pz. шт. pallet Italia</p>	<p>Pz. шт. pallet Cont.</p>
 <p>Undercounter rectangular washbasin Lavabo bajo encimera rectangular / Vasque à encastrer par dessous rectangulaire / Rechteckiges Unterbaubecken / Раковина прямоугольная встроенная под столешницу</p>	<p>58 x 35 x h 15</p>	<p>FILASPR58(X)*</p>		<ul style="list-style-type: none">  Gloss White  *X = N - Gloss Black  *X = FU - Fumo  *X = TP - Talpa  Le Terre di Cielo  Le Acque di Cielo 	<p>319,00 462,00 462,00 462,00 462,00 462,00</p>		
 <p>Filo 90 ceramic countertop - left Encimera de cerámica - izquierda Plaque en céramique - gauche Regal aus keramik - links Керамическая столешница - справа</p>	<p>90 x 53 x h3</p>	<p>FIP90SX(X)* FIP90XSXF(X)* no tap hole sin agujero - sans orifice - ohne Loch без отверстия</p>		<ul style="list-style-type: none">  Gloss White  *X = N - Gloss Black  *X = FU - Fumo  *X = TP - Talpa  Le Terre di Cielo  Le Acque di Cielo 	<p>385,00 550,00 550,00 550,00 550,00 550,00</p>		
 <p>Filo 90 marble countertop - left Encimera de mármol - izquierda Plaque en marbre - gauche Marmor Regal - links Столешница из мрамора - справа</p>	<p>90 x 53 x h3</p>	<p>FIP90MSX(X)* FIP90MSXSXF(X)* no tap hole sin agujero - sans orifice - ohne Loch без отверстия</p>		<ul style="list-style-type: none">  *X = MB - Bianco Carrara Gioia  *X = MN - Nero Marquina 	<p>1210,00 1210,00</p>		
 <p>Filo 90 ceramic countertop - right Encimera de cerámica - derecha Plaque en céramique - droite Regal aus keramik - rechts Керамическая столешница - слева</p>	<p>90 x 53 x h3</p>	<p>FIP90DX(X)* FIP90DXSF(X)* no tap hole sin agujero - sans orifice - ohne Loch без отверстия</p>		<ul style="list-style-type: none">  Gloss White  *X = N - Gloss Black  *X = FU - Fumo  *X = TP - Talpa  Le Terre di Cielo  Le Acque di Cielo 	<p>385,00 550,00 550,00 550,00 550,00 550,00</p>		
 <p>Filo 90 marble countertop - right Encimera de mármol - derecha Plaque en marbre - droite Marmor Regal - rechts Столешница из мрамора - слева</p>	<p>90 x 53 x h3</p>	<p>FIP90MDX(X)* FIP90MDXSXF(X)* no tap hole sin agujero - sans orifice - ohne Loch без отверстия</p>		<ul style="list-style-type: none">  *X = MB - Bianco Carrara Gioia  *X = MN - Nero Marquina 	<p>1210,00 1210,00</p>		
 <p>Filo 90 lacquered cabinet with drawer - vertical handle Mueble lacado Filo 90, con cajón - tirador vertical \ Meuble laqué Filo 90, avec tiroir - poignée verticale \ Möbel Filo 90 lackiert, mit Schublade - Griff vertikal \ Мебель Filo 90 в крашенной отделке, с ящиком - вертикальная ручка</p>	<p>90 x 55 x h 45</p>	<p>FIC90LV(X)*</p>		<ul style="list-style-type: none">  *X = FU - Fumo  *X = TP - Talpa  Le Terre di Cielo*  Le Acque di Cielo 	<p>1887,00 1887,00 1733,00 1887,00</p>		
 <p>Filo 90 cabinet in wood with drawer - vertical handle Mueble de madera Filo 90 con cajón - tirador vertical \ Meuble Filo 90 en bois avec tiroir - poignée verticale \ Möbel Filo 90 aus Holz mit Schublade - Griff vertikal \ Мебель Filo 90 в отделке из шпона, с ящиком - вертикальная ручка</p>	<p>90 x 55 x h 45</p>	<p>FIC90EV(X)*</p>		<ul style="list-style-type: none">  Esenze Rovere •  *X = EU - Eucalipto 	<p>2145,00 2420,00</p>		

ATTENTION: Compulsory washbasin + countertop + cabinet. The washbasin can also be purchased individually.
ATENCIÓN: composición obligatoria lavabo + encimera + mueble. El lavabo también se puede adquirir individualmente.
ATTENTION: composition vasque + plan/top + meuble obligatoire. La vasque peut également être achetée individuellement.
ACHTUNG: Verpflichtung zum Kauf von Waschbecken + Arbeitsplatte + Unterschrank. Das Waschbecken kann auch einzeln gekauft werden.
ВНИМАНИЕ: Обязательный набор: тумбочка + столешница + мебель. Раковина может быть приобретением отдельно.

	Size (cm) Medidas Dimensions Maße Размеры	Product code Artículo Article Artikel Артикул	Net weight (Kg) Peso neto Poids net Reingewicht вес нетто	Finishes Acabados Finitions Farbe Отделки	Euro Евро	Pz. шт. pallet Italia	Pz. шт. pallet Cont.
 <p>Filo 90 ceramic countertop Encimera de cerámica Plaque en céramique Regal aus Keramik Керамическая столешница</p> 	90 x 53 x h3	FIP90(X)*		<ul style="list-style-type: none">  Gloss White  *X = N - Gloss Black  *X = FU - Fumo  *X = TP - Talpa  Le Terre di Cielo  Le Acque di Cielo 	341,00		
		FIP90M(X)*		<ul style="list-style-type: none">  *X = MB - Bianco Carrara Gioia  *X = MN - Nero Marquina 	506,00		
 <p>Filo 90 lacquered cabinet with drawer – vertical handle version without washbasin Mueble lacado Filo 90, con cajón - tirador vertical, versión sin lavabo Meuble laqué Filo 90, avec tiroir - poignée verticale, version sans vasque Möbel Filo 90 lackiert, mit Schublade - Griff vertikal, Ausführung ohne Waschbecken Мебель Filo 90 в крашенной отделке, с ящиком - вертикальная ручка, версия без раковины</p> 	90 x 55 x h 45	FIC90LVSF(X)*		<ul style="list-style-type: none">  *X = FU - Fumo  *X = TP - Talpa  Le Terre di Cielo*  Le Acque di Cielo 	1887,00		
		FIC90EVSF(X)*		<ul style="list-style-type: none">  EsSENze Rovere •  *X = EU - Eucalpto 	1887,00		
<p>Filo 90 cabinet in wood with drawer – vertical handle version without washbasin Mueble Filo 90 de madera, con cajón - tirador vertical, versión sin lavabo Meuble Filo 90 en bois, avec tiroir - poignée verticale, version sans vasque Möbel Filo 90 aus Holz, mit Schublade - Griff vertikal, Ausführung ohne Waschbecken Мебель Filo 90 в крашенной отделке, с ящиком - вертикальная ручка, версия без раковины</p> 							

Technical symbols legend / Símbolos técnicos clave / Légende symboles techniques / Technische Zeichenerklärung / Перечень технических символов















 with overflow con rebosadero avec trop-plein mit Überlauf с переливом	 fitted installation instalación en encimera Installation sous plan Unterbaumontage встраиваемая установка	 one tap hole con 1 agujero monotrou 1-Loch одно отверстие под смеситель	 no tap hole on request sin agujero, solo a petición sans orifice sur demande auf Anfrage ohne Loch без отверстия под смеситель по запросу
---	--	---	---







Mandatory composition: FIP90/FIP90M + FIC90LVSF/FIC90EVSF
Composición obligatoria: FIP90/FIP90M + FIC90LVSF/FIC90EVSF
Composition obligatoire: FIP90/FIP90M + FIC90LVSF/FIC90EVSF
Das Möbel besteht obligatorisch aus: FIP90/FIP90M + FIC90LVSF/FIC90EVSF
Обязательный комплект: FIP90/FIP90M + FIC90LVSF/FIC90EVSF

Le Terre di Cielo	 TL - Talco	 PM - Pomice	 BR - Brina	 BA - Basalto	 LV - Lavagna	 CM - Cemento	 FN - Fango	 CA - Cacao
	 AN - Arenaria	 AV - Avena	 LN - Lino	 AG - Agave	 MU - Muschio	 PL - Polvere	 CP - Cipria	 CN - Canapa
Le Acque di Cielo	 OL - Oltremare	 SM - Smeraldo	 AL - Alga	 CO - Corallo	 NI - Ninfea	 AM - Anemone		

• EsSENze Rovere	 RS - Rovere Sbiancato	 RN - Rovere Naturale	 RN - Rovere Nero	 RT - Rovere Tinto Noce
-------------------------	---	--	--	--

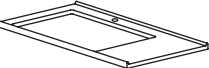
* Terre/Acque di Cielo laquering available for cabinet
/ lacados Terre/Acque di Cielo disponibles para mueble /
laquages Terre/Acque di Cielo disponibles pour le meuble /
Für Möbel erhältliche Lackierungen Terre/Acque di Cielo /
крашенная отделка Terre/Acque di Cielo доступна для
ящика и столешницы

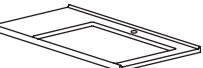
 TL - Talco	 PM - Pomice	 BR - Brina	 AN - Arenaria	 AV - Avena
 CM - Cemento	 BA - Basalto	 MU - Muschio	 AG - Agave	
 OL - Oltremare	 SM - Smeraldo	 AL - Alga	 CO - Corallo	 NI - Ninfea
			 AM - Anemone	

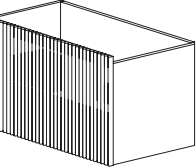
	Size (cm)	Product code	Net weight(Kg)	Finishes	Euro	Pz.	Pz.
	Medidas Dimensions Maße Размеры	Artículo Article Artikel Артикул	Peso neto Poids net Reingewicht вес нетто	Acabados Finitions Farbe Отделки	Евро	шт. pallet Italia	шт. pallet Cont.
<p>drains and siphons pg. 19 desagües y sifones pg. 19 les drains et les siphons pg. 19 Ablaufgarnituren und Siphons pg. 19 Донные клапаны и сифоны pg. 19</p>   <p>Undercounter rectangular washbasin Lavabo bajo encimera rectangular / Vasque à encastrer par dessous rectangulaire / Rechteckiges Unterbaubecken / Раковина прямоугольная встроенная под столешницу</p>	58 x 35 x h 15	FILASPR58(X)*		<ul style="list-style-type: none"> Gloss White 319,00 *X = N - Gloss Black 462,00 *X = FU - Fumo 462,00 *X = TP - Talpa 462,00 Le Terre di Cielo 462,00 Le Acque di Cielo 462,00 			
<p> Filo 90 ceramic countertop - left Encimera de cerámica - izquierda Plaque en céramique - gauche Regal aus Keramik - links Керамическая столешница - справа</p>  <p>Filo 90 marble countertop - left Encimera de mármol - izquierda Plaque en marbre - gauche Marmor Regal - links Столешница из мрамора - справа</p>	90 x 53 x h3	FIP90SX(X)*		<ul style="list-style-type: none"> Gloss White 385,00 *X = N - Gloss Black 550,00 *X = FU - Fumo 550,00 *X = TP - Talpa 550,00 Le Terre di Cielo 550,00 Le Acque di Cielo 550,00 			
		FIP90MSX(X)* FIP90MSXS(X)* no tap hole sin agujero - sans orifice - ohne Loch без отверстия	<ul style="list-style-type: none"> *X = MB - Bianco Carrara Gioia 1210,00 *X = MN - Nero Marquina 1210,00 				
<p> Filo 90 ceramic countertop - right Encimera de cerámica - derecha Plaque en céramique - droite Regal aus Keramik - rechts Керамическая столешница - слева</p>  <p>Filo 90 marble countertop - right Encimera de mármol - derecha Plaque en marbre - droite Marmor Regal - rechts Столешница из мрамора - слева</p>	90 x 53 x h3	FIP90DX(X)*		<ul style="list-style-type: none"> Gloss White 385,00 *X = N - Gloss Black 550,00 *X = FU - Fumo 550,00 *X = TP - Talpa 550,00 Le Terre di Cielo 550,00 Le Acque di Cielo 550,00 			
		FIP90MDX(X)* FIP90MDXS(X)* no tap hole sin agujero - sans orifice - ohne Loch без отверстия	<ul style="list-style-type: none"> *X = MB - Bianco Carrara Gioia 1210,00 *X = MN - Nero Marquina 1210,00 				
<p> Filo 90 cabinet in wood with drawer and slatted front Mueble Filo 90 en madera, con cajón con frente de lamas \ Meuble Filo 90 en bois, avec tiroir avec façade à lattes \ Möbel Filo 90 aus Holz, mit Schublade mit Frontblende in Leistenoptik \ Мебель Filo 90 в отделке из шпона, с ящиком и фронтальной панелью из реек</p> 	90 x 50 x h 45	FICD90E(X)*		<ul style="list-style-type: none"> Essenze Rovere • 2847,00 *X = EU - Eucalipto 3148,00 			











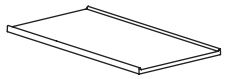

ATTENTION: Compulsory washbasin + countertop + cabinet. The washbasin can also be purchased individually.

ATENCIÓN: composición obligatoria lavabo + encimera + mueble. El lavabo también se puede adquirir individualmente.

ATTENTION: composition vasque + plan/top + meuble obligatoire. La vasque peut également être achetée individuellement.

ACHTUNG: Verpflichtung zum Kauf von Waschbecken + Arbeitsplatte + Unterschrank. Das Waschbecken kann auch einzeln gekauft werden.

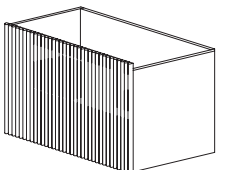
ВНИМАНИЕ: Обязательный набор: тумбочка + столешница + мебель. Раковина может быть приобретением отдельно.

	Size (cm) Medidas Dimensions Maße Размеры	Product code Artículo Article Artikel Артикул	Net weight (Kg) Peso neto Poids net Reingewicht вес нетто	Finishes Acabados Finitions Farbe Отделки	Euro Евро	Pz. шт. pallet Italia	Pz. шт. pallet Cont.
 <p>Filo 90 ceramic countertop Encimera de cerámica Plaque en céramique Regal aus Keramik Керамическая столешница</p> 	90 x 53 x h3	FIP90(X)*		<ul style="list-style-type: none">  Gloss White  *X = N - Gloss Black  *X = FU - Fumo  *X = TP - Talpa  Le Terre di Cielo  Le Acque di Cielo 	<p>341,00</p> <p>506,00</p> <p>506,00</p> <p>506,00</p> <p>506,00</p> <p>506,00</p>		
		FIP90M(X)*		<ul style="list-style-type: none">  *X = MB - Bianco Carrara Gioia  *X = MN - Nero Marquina 	<p>935,00</p> <p>935,00</p>		
 <p>Filo 90 cabinet in wood with drawer and slatted front – version without washbasin Mueble Filo 90 de madera, con cajón con frente de lamas, versión sin lavabo \ Meuble Filo 90 en bois, avec tiroir avec façade à lattes, version sans vasque \ Möbel Filo 90 aus Holz, mit Schublade mit Frontblende in Leistenoptik, Ausführung ohne Waschbecken \ Мебель Filo 90 в отделке из шпона, с ящиком и фронтальной панелью из реек, версия без раковины</p> 	90 x 50 x h 45	FICD90ESF(X)*		<ul style="list-style-type: none">  EsSENze Rovere •  *X = EU - Eucalipto 	<p>2698,00</p> <p>3000,00</p>		

Technical symbols legend / Símbolos técnicos clave / Légende symboles techniques / Technische Zeichenerklärung / Перечень технических символов

 **with overflow**
con rebosadero
avec trop-plein
mit Überlauf
с переливом

 **fitted installation**
instalación en encimera
Installation sous plan
Unterbaumontage
встраиваемая установка

 **one tap hole**
con 1 agujero
monotrou
1-Loch
одно отверстие
под смеситель

 **no tap hole on request**
sin agujero, solo a petición
sans orifice sur demande
auf Anfrage ohne Loch
без отверстия под смеситель по запросу











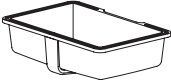







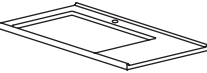







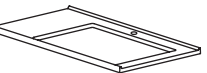



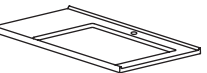







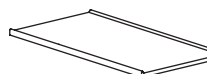

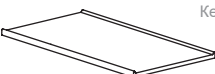

 **Mandatory composition: FIP90/FIP90M + FICD90ESF**
Composición obligatoria: FIP90/FIP90M + FICD90ESF
Composition obligatoire: FIP90/FIP90M + FICD90ESF
Das Möbel besteht obligatorisch aus: FIP90/FIP90M + FICD90ESF
Обязательный комплект: FIP90/FIP90M + FICD90ESF







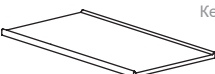



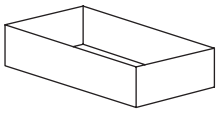



Le Terre di Cielo  TL - Talco  PM - Pomice  BR - Brina  BA - Basalto  LV - Lavagna  CM - Cemento  FN - Fango  CA - Cacao

 AN - Arenaria  AV - Avena  LN - Lino  AG - Agave  MU - Muschio  PL - Polvere  CP - Cipria  CN - Canapa

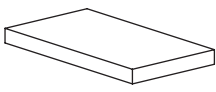
Le Acque di Cielo  OL - Oltremare  SM - Smeraldo  AL - Alga  CO - Corallo  NI - Ninfea  AM - Anemone





 **EsSENze Rovere**  RS - Rovere Sbiancato  RN - Rovere Naturale  RN - Rovere Nero  RT - Rovere Tinto Noce

	Size (cm)	Product code	Net weight(Kg)	Finishes	Euro	Pz.	Pz.
	Medidas Dimensions Maße Размеры	Artículo Article Artikel Артикул	Peso neto Poids net Reingewicht вес нетто	Acabados Finitions Farbe Отделки	Евро	шт. pallet Italia	шт. pallet Cont.
<p>drains and siphons pg. 19 desagües y sifones pg. 19 les drains et les siphons pg. 19 Ablaufgarnituren und Siphons pg. 19 Донные клапаны и сифоны pg. 19</p>   <p>Undercounter rectangular washbasin Lavabo bajo encimera rectangular / Vasque à encastrer par dessous rectangulaire / Rechteckiges Unterbaubecken / Раковина прямоугольная встроенная под столешницу</p>	58 x 35 x h 15	FILASPR58(X)*		<ul style="list-style-type: none">  Gloss White 319,00  *X = N - Gloss Black 462,00  *X = FU - Fumo 462,00  *X = TP - Talpa 462,00  Le Terre di Cielo 462,00  Le Acque di Cielo 462,00 			
<p></p>  <p>Filo 90 ceramic countertop - left Encimera de cerámica - izquierda Plaque en céramique - gauche Regal aus keramik - links Керамическая столешница - справа</p>	90 x 53 x h3	FIP90SX(X)* FIP90SXSF(X)* no tap hole sin agujero - sans orifice - ohne Loch без отверстия		<ul style="list-style-type: none">  Gloss White 385,00  *X = N - Gloss Black 550,00  *X = FU - Fumo 550,00  *X = TP - Talpa 550,00  Le Terre di Cielo 550,00  Le Acque di Cielo 550,00 			
  <p>Filo 90 marble countertop - left Encimera de mármol - izquierda Plaque en marbre - gauche Marmor Regal - links Столешница из мрамора - справа</p>		FIP90MSX(X)* FIP90MSXSF(X)* no tap hole sin agujero - sans orifice - ohne Loch без отверстия		<ul style="list-style-type: none">  *X = MB - Bianco Carrara Gioia 1210,00  *X = MN - Nero Marquina 1210,00 			
<p></p>  <p>Filo 90 ceramic countertop - right Encimera de cerámica - derecha Plaque en céramique - droite Regal aus keramik - rechts Керамическая столешница - слева</p>	90 x 53 x h3	FIP90DX(X)* FIP90DXSF(X)* no tap hole sin agujero - sans orifice - ohne Loch без отверстия		<ul style="list-style-type: none">  Gloss White 385,00  *X = N - Gloss Black 550,00  *X = FU - Fumo 550,00  *X = TP - Talpa 550,00  Le Terre di Cielo 550,00  Le Acque di Cielo 550,00 			
  <p>Filo 90 marble countertop - right Encimera de mármol - derecha Plaque en marbre - droite Marmor Regal - rechts Столешница из мрамора - слева</p>		FIP90MDX(X)* FIP90MDXSF(X)* no tap hole sin agujero - sans orifice - ohne Loch без отверстия		<ul style="list-style-type: none">  *X = MB - Bianco Carrara Gioia 1210,00  *X = MN - Nero Marquina 1210,00 			
<p></p>  <p>Filo 90 ceramic countertop Encimera de cerámica Plaque en céramique Regal aus keramik Керамическая столешница</p>	90 x 53 x h 15	FIP90(X)*		<ul style="list-style-type: none">  Gloss White 341,00  *X = N - Gloss Black 506,00  *X = FU - Fumo 506,00  *X = TP - Talpa 506,00  Le Terre di Cielo 506,00  Le Acque di Cielo 506,00 			
<p></p>  <p>Filo 90 marble countertop Encimera de mármol Plaque en marbre Marmor Regal Столешница из мрамора</p>		FIP90M(X)*		<ul style="list-style-type: none">  *X = MB - Bianco Carrara Gioia 935,00  *X = MN - Nero Marquina 935,00 			

	Size (cm) Medidas Dimensions Maße Размеры	Product code Artículo Article Artikel Артикул	Net weight (kg) Peso neto Poids net Reingewicht вес нетто	Finishes Acabados Finitions Farbe Отделки	Euro Евро
 <p>Filo lacquered washbasin base unit Base de lavabo lacada \ Base vasque laquée \ Lackierter Waschbeckenunterbau \ Лакированное основание умывальника</p> 	90 x 55 x h 21	FIB90L(X)*		<ul style="list-style-type: none">  *X = FU - Fumo  *X = TP - Talpa  Le Terre di Cielo*  Le Acque di Cielo 	<p>1166,00</p> <p>1166,00</p> <p>1001,00</p> <p>1166,00</p>
		FIB90E(X)*		<ul style="list-style-type: none">  Essenze Rovere •  Eucalipto 	<p>1243,00</p> <p>1474,00</p>
 <p>Filo shelf - lacquered Estante lacado / étagère laqué / lackiertes Regal / Полочка крашенные</p> 	90 x 50 x h 7	FIM90L(X)*		<ul style="list-style-type: none">  *X = FU - Fumo  *X = TP - Talpa  Le Terre di Cielo*  Le Acque di Cielo 	<p>902,00</p> <p>902,00</p> <p>748,00</p> <p>902,00</p>
		FIM90E(X)*		<ul style="list-style-type: none">  Essenze Rovere •  *X = EU - Eucalipto 	<p>864,00</p> <p>935,00</p>

 **ATTENTION: Compulsory washbasin + countertop + cabinet. The washbasin can also be purchased individually.**
ATENCIÓN: composición obligatoria lavabo + encimera + mueble. El lavabo también se puede adquirir individualmente.
ATTENTION: composition vasque + plan/top + meuble obligatoire. La vasque peut également être achetée individuellement.
ACHTUNG: Verpflichtung zum Kauf von Waschbecken + Arbeitsplatte + Unterschrank. Das Waschbecken kann auch einzeln gekauft werden.
ВНИМАНИЕ: Обязательный набор: тумбочка + столешница + мебель. Раковина может быть приобретением отдельно.

Technical symbols legend / Símbolos técnicos clave / Légende symboles techniques / Technische Zeichenerklärung /
Перечень технических символов











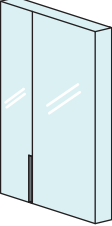
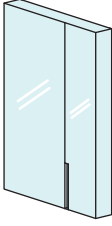

-  **with overflow**
con rebosadero / avec trop-plein / mit Überlauf / с переливом
-  **fitted installation**
instalación en encimera / installation sous plan / Unterbaumontage / встраиваемая установка
-  **one tap hole**
con 1 agujero monotrou / 1-Loch / одно отверстие под смеситель
-  **no tap hole on request**
sin agujero, solo a petición / sans orifice sur demande / auf Anfrage ohne Loch / без отверстия под смеситель по запросу

- Le Terre di Cielo
-  TL - Talco
 -  PM - Pomice
 -  BR - Brina
 -  BA - Basalto
 -  LV - Lavagna
 -  CM - Cemento
 -  FN - Fango
 -  CA - Cacao
 -  AN - Arenaria
 -  AV - Avena
 -  LN - Lino
 -  AG - Agave
 -  MU - Muschio
 -  PL - Polvere
 -  CP - Cipria
 -  CN - Canapa
- Le Acque di Cielo
-  OL - Oltremare
 -  SM - Smeraldo
 -  AL - Alga
 -  CO - Corallo
 -  NI - Ninfea
 -  AM - Anemone

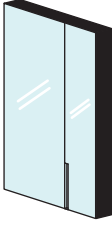
Terre\Acque di Cielo available for base and shelf / Terre\Acque di Cielo disponibles para base y estante / Terre\Acque di Cielo disponibles pour base et étagère / Erhältlich für Waschbeckenunterbau und Ablage Terre\Acque di Cielo / Terre\Acque di Cielo доступен для основания и полки

-  TL - Talco
-  PM - Pomice
-  BR - Brina
-  AN - Arenaria
-  AV - Avena
-  CM - Cemento
-  BA - Basalto
-  MU - Muschio
-  AG - Agave
-  OL - Oltremare
-  SM - Smeraldo
-  AL - Alga
-  CO - Corallo
-  NI - Ninfea
-  AM - Anemone

- Essenze Rovere
-  RS - Rovere Sbiancato
-  RN - Rovere Naturale
-  RN - Rovere Nero
-  RT - Rovere Tinto Noce

	Size (cm) Medidas Dimensions Maße Размеры	Product code Artículo Article Artikel Артикул	Net weight (kg) Peso neto Poids net Reingewicht вес нетто	Finishes Acabados Finitions Farbe Отделки	Euro Евро	Pz. шт. pallet Italia	Pz. шт. pallet Cont.
 <p>Container mirror with led light - right Espejo contenedor con luz led - derecha / Miroir avec rangement avec éclairage led - droit / Spiegelschrank mit LED-Beleuchtung - Rechts / Зеркальный верно шкафчик - справа</p>	90 x 13 x h 110	FISPCGLDXS			1859,00		
 <p>Container mirror with led light - left Espejo contenedor con luz led - izquierda / Miroir avec rangement avec éclairage led - gauche / Spiegelschrank mit LED-Beleuchtung - Links / Зеркальный верно шкафчик - слева</p>	90 x 13 x h 110	FISPCGLSXS			1859,00		
 <p>Container mirror with led light with lacquered box-right Espejo contenedor con borde lacado con luz led - derecha / Miroir avec rangement avec corps laqué avec éclairage led - droit / Spiegelschrank mit LED-Beleuchtung, Gestell lackiert - Rechts / Зеркальный верно шкафчик с крашенной рамой - справа</p>	90 x 13 x h 110	FISPCGLDXL(X)*		<ul style="list-style-type: none">  *X = NM - Matt Black  *X = CM - Cemento  *X = FU - Fumo  *X = TP - Talpa  Le Acque di Cielo 	1782,00 1782,00 2002,00 2002,00 2002,00		
 <p>Container mirror with led light with lacquered box-left Espejo contenedor con borde lacado con luz led - izquierda / Miroir avec rangement avec corps laqué avec éclairage led - gauche / Spiegelschrank mit LED-Beleuchtung, Gestell lackiert - Links / Зеркальный верно шкафчик с крашенной рамой - слева</p>	90 x 13 x h 110	FISPCGLSXL(X)*		<ul style="list-style-type: none">  *X = NM - Matt Black  *X = CM - Cemento  *X = FU - Fumo  *X = TP - Talpa  Le Acque di Cielo 	1782,00 1782,00 2002,00 2002,00 2002,00		



Otis

design Giuseppe Pezzano e Andrea Parisio



indice collezione \ collection index pg. 33

listino prezzi \ price list pg. 36 - 43

Washbasins finishes

Acabados de Lavabos \ Finitions
des Lavabos \ Waschbecken
Farbe \ Отделки Раковина

Essential Colours

-  Gloss White
-  Gloss Black
-  FU - Fumo **NEW**
-  TP - Talpa **NEW**

Le Terre di Cielo

-  TL - Talco
-  PM - Pomice
-  BR - Brina
-  CM - Cemento
-  BA - Basalto
-  LV - Lavagna
-  FN - Fango
-  CA - Cacao
-  AN - Arenaria
-  AV - Avena
-  MU - Muschio
-  AG - Agave
-  LN - Lino
-  CN - Canapa
-  CP - Cipria
-  PL - Polvere

Le Acque di Cielo

-  OL - Oltremare
-  SM - Smeraldo
-  AL - Alga
-  CO - Corallo
-  NI - Ninfea
-  AM - Anemone

WC and Bidets finishes

Acabados de Sanitarios \ Finitions
des WC et Bidets \ WC und Bidet
Farbe \ Отделки Унитаз и Биде

Essential Colors

-  Gloss White
-  Gloss Black
-  FU - Fumo **NEW**
-  TP - Talpa **NEW**

Le Terre di Cielo

-  TL - Talco
-  PM - Pomice
-  LN - Lino
-  BR - Brina
-  AV - Avena
-  AN - Arenaria
-  CM - Cemento
-  BA - Basalto
-  LV - Lavagna

Le Acque di Cielo

-  OL - Oltremare
-  SM - Smeraldo
-  AL - Alga
-  CO - Corallo
-  NI - Ninfea
-  AM - Anemone

The possible variations of the colour cannot be considered as defect, but as a guarantee of the completely artisan manufacturing of this unique and high quality product. / Las variaciones de colores no se consideran un defecto sino una garantía de una elaboración manual y artesanal en un producto único y de calidad. / Les éventuelles variations de couleur ne peuvent être considérées comme des défauts, elles témoignent en revanche d'une méthode de travail totalement manuelle et artisanale employée pour obtenir un produit fini unique et de qualité. / Eventuelle Farbvariationen sind nicht als Mangel anzusehen, sondern als Garantie für die komplett handwerkliche Anfertigung eines einzigartigen und hochqualitativen Produkts. / Возможные вариации цвета не могут считаться дефектом, а являются подтверждением ручной работы, гарантией качества и уникальности изделия.

Lavabi / washbasins

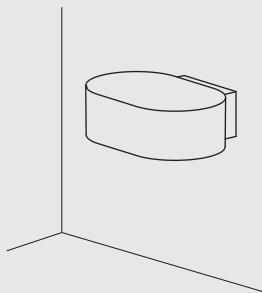

OTLS
60 x 47 x h20
pag. 36

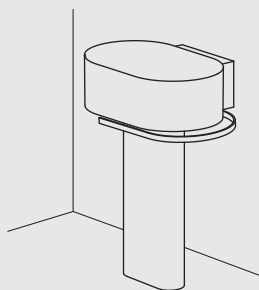

OTLS/OTCOL
60 x 47 x h 87
pag. 36

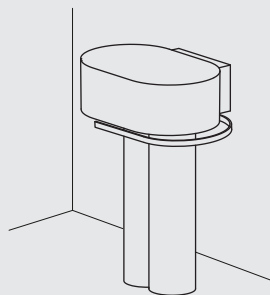

OTLS/OTCOLD
60 x 47 x h 87
pag. 36

Mensole / shelves



Mensola Semicerchio
semicircular shelf
28 x 18 x h 3
pag. 36



Mensola Tonda
round shelf
ø 17 x h 2
pag. 36

Wc - bidet

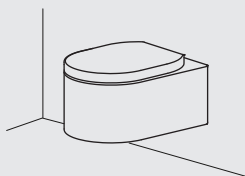

OTVSK
56 x 39 x h25
pag. 38

CIELO RIMLESS 2.01®

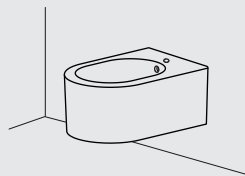

OTBS
56 x 39 x h25
pag. 39

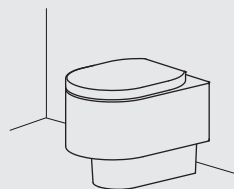

OTVAK
56 x 39 x h 42
pag. 40



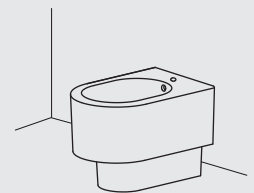





















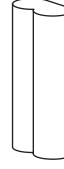









CIELO RIMLESS 2.01®













OTBI
56 x 39 x h 42
pag. 41





	Size (cm) Medidas Dimensions Maße Размеры	Product code Artículo Article Artikel Артикул	Net weight (Kg) Peso neto Poids net Reingewicht вес нетто	Finishes Acabados Finitions Farbe Отделки	Euro Евро	Pz. шт. pallet Italia	Pz. шт. pallet Cont.
 <p>Single-hole oval suspended washbasin Lavabo suspendido oval con 1 agujero Lavabo suspendu ovale mon trou Aufsatzbecken Hängender Oval 1-Loch Раковина подвесная овальный одно отверстие под смеситель</p>	60 x 47 x h 20	OTLS(X)* OTLSSF(X)* no tap hole sin agujero sans orifice ohne Loch без отверстия	15,50	<ul style="list-style-type: none">  Gloss White  *X = N - Gloss Black  *X = FU - Fumo  *X = TP - Talpa  Le Terre di Cielo  Le Acque di Cielo 	550,00 792,00 792,00 792,00 792,00 792,00		
<p>The washbasin is recommended for wall hung installation. For on top installation customers are advised to require the "RETTIFICA" option. Se recomienda la instalación del lavabo suspendido. Para instalaciones de apoyo se aconseja usar la opción "RETTIFICA". / La vasque est recommandée pour l'installation suspendu. Pour l'installation à poser on conseille l'option "RETTIFICA". / Es empfiehlt sich, das Waschbecken hängend zu installieren. Bei Aufsatzmontage bitte die Option "RETTIFICA" anfragen. / Данная раковина предназначена для подвесной установки. При установке на столешницу рекомендуется запросить опцию "RETTIFICA".</p>		RETTIFICA GRINDING РЕКТИФИКАЦИЯ			10,00		
 <p>Smooth column Colonne Columna Säule Waschbeckensäule пьедеста</p>	30 x 14 x h 67	OTCOL(X)*	17,50	<ul style="list-style-type: none">  Gloss White  *X = N - Gloss Black  *X = FU - Fumo  *X = TP - Talpa  Le Terre di Cielo  Le Acque di Cielo 	275,00 385,00 385,00 385,00 385,00 385,00		
 <p>Twin column Colonne Columna Säule Waschbeckensäule пьедеста</p>	32 x 18 x h 67	OTCOLD(X)*	16,00	<ul style="list-style-type: none">  Gloss White  *X = N - Gloss Black  *X = FU - Fumo  *X = TP - Talpa  Le Terre di Cielo  Le Acque di Cielo 	297,00 418,00 418,00 418,00 418,00 418,00		
 <p>*Semicircular shelf - ceramic Estante semicircular en cerámico / étagère semi-circulaire en céramique / halbrundes Keramik / Полочка круглая из керамический</p>	28 x 18 x h 3	OTMS(X)*		<ul style="list-style-type: none">  Gloss White  *X = N - Gloss Black  *X = FU - Fumo  *X = TP - Talpa  Le Terre di Cielo  Le Acque di Cielo 	132,00 176,00 176,00 176,00 176,00 176,00		
<p>Semicircular shelf - wood Iroko Estante semicircular - madera Iroko / étagère semi-circulaire-bois Iroko / halbrundes Regal - Holz Iroko / Полочка полукруглая деревянная Iroko</p>		OTMSE		<ul style="list-style-type: none">  Iroko 	275,00		
 <p>*Round shelf - ceramic Estante redondo en cerámico / étagère ronde en céramique / konsolerund aus Keramik / Полочка круглая из керамический</p>	ø 17 x h 2	OTMT(X)*		<ul style="list-style-type: none">  Gloss White  *X = N - Gloss Black  *X = FU - Fumo  *X = TP - Talpa Le Terre di Cielo Le Acque di Cielo 	132,00 176,00 176,00 176,00 176,00 176,00		
<p>Round shelf - wood Iroko Estante redondo - madera Iroko / étagère ronde - bois Iroko / konsolerund - Holz Iroko / Полочка круглая деревянная Iroko</p>		OTMTE		<ul style="list-style-type: none">  Iroko 	220,00		

	Size (cm)	Product code Artículo Article Artikel Артикул	Net weight (Kg) Peso neto Poids net Reingewicht вес нетто	Finishes Acabados Finitions Farbe Отделка	Euro Евро
 Right-hand side towel rail	37 x 42 x h 3	OTPLDX(x)*	1,10	● *X = NM - Matt Black	160,00
		OTPLSX(x)*		● *X = CM - Cemento	165,00
 Left-hand side towel rail				● *X = FU - Fumo	176,00
				● *X = TP - Talpa	176,00
				● Le Acque di Cielo	176,00
 Universal click/clack drain in CHROME with ceramic lid Válvula universal click/clack Cromado con tapa en cerámica Bonde universelle clic/clac Chromé avec clapet en céramique Universal-Ablaufgarnitur Click-Clack Chrom mit Keramikstopfen Универсальный донный клапан click/clack хром с керамической крышкой		PIL01(x)*	0,40	○ Gloss White	95,00
				● *X = N - Gloss Black	114,00
				● *X = FU - Fumo	139,00
				● *X = TP - Talpa	139,00
				● Le Terre di Cielo	139,00
				● Le Acque di Cielo	139,00
 Universal click/clack drain in BLACK MATT finish with ceramic lid Válvula universal click/clack Negro Matt con tapa en cerámica Bonde universelle clic/clac Noir Mat avec clapet en céramique Universal-Ablaufgarnitur Click-Clack Matt Schwarz mit Keramikstopfen Универсальный донный клапан click/clack черный матовый с керамической крышкой		PIL01NM(x)*	0,40	○ Gloss White	120,00
				● *X = N - Gloss Black	159,00
				● *X = FU - Fumo	169,00
				● *X = TP - Talpa	169,00
				● Le Terre di Cielo	169,00
				● Le Acque di Cielo	169,00
 Universal click/clack drain in CEMENTO finish with ceramic lid Válvula universal click/clack Cemento con tapa en cerámica Bonde universelle clic/clac Cemento avec clapet en céramique Universal-Ablaufgarnitur Click-Clack Cement mit Keramikstopfen Универсальный донный Cemento click/clack с керамической крышкой		PIL01CM(x)*	0,40	○ Gloss White	120,00
				● *X = N - Gloss Black	159,00
				● *X = FU - Fumo	169,00
				● *X = TP - Talpa	169,00
				● Le Terre di Cielo	169,00
				● Le Acque di Cielo	169,00
 Universal click/clack drain in BRONZE with ceramic lid Válvula universal click/clack Bronce con tapa en cerámica Bonde universelle clic/clac Bronze avec clapet en céramique Universal-Ablaufgarnitur Click-Clack Bronze mit Keramikstopfen Универсальный донный клапан click/clack бронза с керамической крышкой		PIL01BR(x)*	0,40	○ Gloss White	135,00
				● *X = N - Gloss Black	171,00
				● *X = FU - Fumo	182,00
				● *X = TP - Talpa	182,00
				● Le Terre di Cielo	182,00
				● Le Acque di Cielo	182,00
 CHROMED siphon Sifone Cromado \ Siphon Chromé \ Siphon Verchromt \ сифон Chrome		SISP	0,93	● Chrome	133,00
 MATT BLACK siphon Sifone Negro Mate \ Siphon Noir Mat \ Siphon Schwarz Matt \ Сифон Черный матовый		SIFN	0,93	● Matt Black	194,00
 CEMENTO siphon Sifone Cemento \ Siphon Cemento \ Siphon Cemento \ сифон Cemento		SIFCM	0,93	● Cemento	194,00
 BRONZE siphon Sifone Bronce \ Siphon Bronce \ Siphon Bronze \ бронза сифон		SIFBR	0,93	● Bronze	220,00

Technical symbols legend | Símbolos técnicos clave | Légende symboles techniques | Technische Zeichenerklärung | Перечень технических символов

 one tap hole con 1 agujero μονοτρύπη 1-Loch одно отверстие под смеситель	 no tap hole on request sin agujero, solo a petición avec un côté non émaillé sans orifice sur demande auf Anfrage ohne Loch без отверстия под смеситель по запросу	 one side is unglazed con un lado sin esmaltar avec un côté non émaillé eine Seite unglasiert одна сторона не покрыта эмалью	 without overflow / sin rebosadero / sans trop-plein / ohne Überlauf / без слива-перелива	 on top installation instalación de apoyo / installation à partir du plan / Montage auf Platte / установка на столешницу	 wall-hung installation instalación suspendida / installation suspendue / wandhängende Montage / подвесная установка	 with fixing parts fijaciones incluidas / fixations incluses / inklusive Befestigungen / в комплекте с крепежами
--	--	--	---	---	---	---

Le Terre di Cielo	○ TL - Talco	● PM - Pomice	● BR - Brina	● BA - Basalto	● LV - Lavagna	● CM - Cemento	● FN - Fango	● CA - Cacao
	● AN - Arenaria	● AV - Avena	● LN - Lino	● AG - Agave	● MU - Muschio	● PL - Polvere	● CP - Cipria	● CN - Canapa
Le Acque di Cielo	● OL - Oltremare	● SM - Smeraldo	● AL - Alga	● CO - Corallo	● NI - Ninfea	● AM - Anemone		

CIELO RIMLESS 2.0.1®



Wall-hung wc with fixing kit (4,5 LT) - rimless 2.0.1

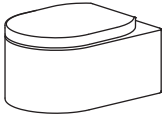

Inodoro suspendido completo con fijaciones (4,5 LT) - sin brida - rimless 2.0.1 / Cuvette suspendue avec fixations (4,5 LT) - sans bride - rimless 2.0.1 / Wand-WC mit Befestigungskit (4,5 Lt.) - ohne Spülrand - rimless 2.0.1 / Подвесной унитаз в комплекте с крепежами (4,5 литр) - без ободка - rimless 2.0.1

	Size (cm) Medidas Dimensions Maße Размеры	Product code Artículo Article Artikel Артикул	Net weight (Kg) Peso neto Poids net Reingewicht вес нетто	Finishes Acabados Finitions Farbe Отделки	Euro Евро	Pz. шт. pallet Italia	Pz. шт. pallet Cont.
<p>QUICK RELEASE HINGES </p> <p>Thermosetting seat & cover Asiento para inodoro Abattant thermdurcissable Wc-sitz thermotur Сиденье из термоотверждающейся смолы</p>	56 x 39 x h25	OTVSK(X)*	26,00	<ul style="list-style-type: none"> Gloss White *X = TL - Talco *X = N - Gloss Black *X = FU - Fumo *X = TP - Talpa Le Terre di Cielo * Le Acque di Cielo 	473,00 616,00 693,00 693,00 693,00 693,00		
<p>QUICK RELEASE HINGES </p> <p>Thermosetting soft close seat & cover Asiento para inodoro amortiguado Abattant thermdurcissable soft Wc-sitz thermotur mit Abs. Сиденье из термоотверждающейся смолы с плавным опусканием</p>		CPVOTT(X)*		<ul style="list-style-type: none"> Gloss White *X = TL - Talco *X = N - Gloss Black *X = FU - Fumo *X = TP - Talpa Le Terre di Cielo * Le Acque di Cielo 	110,00		
<p>QUICK RELEASE HINGES </p> <p>Thermosetting soft close seat & cover Asiento para inodoro amortiguado Abattant thermdurcissable soft Wc-sitz thermotur mit Abs. Сиденье из термоотверждающейся смолы с плавным опусканием</p>		CPVOTT(X)*		<ul style="list-style-type: none"> Gloss White *X = TL - Talco *X = N - Gloss Black *X = FU - Fumo *X = TP - Talpa Le Terre di Cielo * Le Acque di Cielo 	188,00 296,00 316,00 316,00 316,00 316,00		
<p>Impact and acoustic protection panel Protección antigolpes y acústica Protection acoustique et anti-choc Stoss- und Schalldämmung Противоударная и акустическая защита</p>		PAA			17,00		
<p>Couple of fixing brackets for wall-hung wc/bidet Pareja de estribo para Inodoro/Bidet suspendido Étriers de fixation pour Wc/Bidet suspendus 1 Paar Halterungen für wandhängendes Wc/Bidet Монтажная рама для подвесного унитаза/биде</p>	3,3 x 18,5 x 55 h	508			39,00		

Technical symbols legend











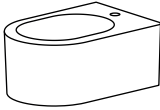



























Símbolos técnicos clave | Légende symboles techniques | Technische Zeichenerklärung | Перечень технических символов

wall-hung installation / instalación suspendida / installation suspendue / wandhängende Montage / подвесная установка
with fixing parts / fijaciones incluidas / fixations incluses / inklusive Befestigungen / в комплекте с крепежами
4,5 l toilet tank / descarga 4,5 lt / évacuation à 4,5 l / 4,5 l-Spülung / бачок на 4,5 л
Combifix compatibility / compatible Combifix / mit Combifix kompatibel / совместим с combifix
quick release hinge / sistema extraíble / charnières à ouverture / Takeoff Funktion / быстрый съем
with overflow / con rebosadero / avec trop-plein / mit Überlauf / с переливом
one tap hole / con 1 agujero / monotrou / 1-Loch / одно отверстие под смеситель











Acque di Cielo available for wc-bidet / Acque di Cielo disponibles para wc-bidet / Acque di Cielo disponibles pour cuvette-bidet / Für das WC/Bidet erhältliche Ausführungen Acque di Cielo / Отделки Acque di Cielo доступны для унитаза и биде

- DL - Oltremare**
- SM - Smeraldo**
- AL - Alga**
- CO - Corallo**
- NI - Ninfea**
- AM - Anemone**
- TL - Talco**
- PM - Pomice**
- BR - Brina**
- AN - Arenaria**
- AV - Avena**
- CM - Cemento**
- LN - Lino**
- BA - Basalto**
- LV - Lavagna**







* Terre di Cielo finishes available for wc-bidet / Acabados Terre di Cielo disponibles para wc-bidet / Finitions Terre di Cielo disponibles pour cuvette-bidet / Für das WC/Bidet erhältliche Ausführungen Terre di Cielo / Отделки Terre di Cielo доступны для унитаза и биде

	Size (cm)	Product code	Net weight (Kg)	Finishes	Euro	Pz.	Pz.
	Medidas Dimensions Maße Размеры	Artículo Article Artikel Артикул	Peso neto Poids net Reingewicht вес нетто	Acabados Finitions Farbe Отделка	Евро	шт. pallet Italia	шт. pallet Cont.
 <p>Wall-hung one hole bidet with fixing kit Bidé suspendido monoagujero completo con fijaciones / Bidet suspendu monotrou avec fixation / Wand-Bidet einloch mit Befestigungskit / Биде подвесное с одним отверстием под смеситель, в комплекте с крепежами</p>	56 x 39 x h25	OTBS(X)*	24,00	<ul style="list-style-type: none">  Gloss White  *X = TL - Talco  *X = N - Gloss Black  *X = FU - Fumo  *X = TP - Talpa  Le Terre di Cielo *  Le Acque di Cielo 	451,00 561,00 649,00 649,00 649,00 649,00 649,00		
 <p>Impact and acoustic protection panel / Protección antigolpes y acústica / Protection acoustique et anti-choc / Stoss- und Schalldämmung / Противоударная и акустическая защита</p>		PAA	0,16		17,00		
 <p>Couple of fixing brackets for wall-hung wc/bidet - Pareja de estribo para Inodoro/Bidet suspendido / Étriers de fixation pour Wc/Bidet suspendus / 1 Paar Halterungen für wandhängendes Wc/ Bidet / Монтажная рама для подвесного унитаза/биде</p>	3,3 x 18,5 x 55 h	508	2,00		39,00		
 <p>Universal click/clack drain in CHROME with ceramic lid Válvula universal click/clack Cromado con tapa en cerámica / Bonde universelle clic/clac Chromé avec clapet en céramique / Universal-Ablaufgarnitur Click-Clack Chrom mit Keramikstopfen / Универсальный донный клапан click/clack хром с керамической крышкой</p>		PIL01(X)*	0,40	<ul style="list-style-type: none">  Gloss White  *X = N - Gloss Black  *X = FU - Fumo  *X = TP- Talpa  Le Terre di Cielo  Le Acque di Cielo 	95,00 114,00 139,00 139,00 139,00 139,00		
 <p>Universal click/clack drain in BLACK MATT finish with ceramic lid / Válvula universal click/clack Negro Matt con tapa en cerámica / Bonde universelle clic/clac Noir Mat avec clapet en céramique / Universal-Ablaufgarnitur Click-Clack Matt Schwarz mit Keramikstopfen / Универсальный донный клапан click/clack черный матовый с керамической крышкой</p>		PIL01NM(X)*	0,40	<ul style="list-style-type: none">  Gloss White  *X = N - Gloss Black  *X = FU - Fumo  *X = TP- Talpa  Le Terre di Cielo  Le Acque di Cielo 	120,00 159,00 169,00 169,00 169,00 169,00		
 <p>Universal click/clack drain in CEMENTO finish with ceramic lid / Válvula universal click/clack Cemento con tapa en cerámica / Bonde universelle clic/clac Cemento avec clapet en céramique / Universal-Ablaufgarnitur Click-Clack Cement mit Keramikstopfen / Универсальный донный клапан Cemento click/clack с керамической крышкой</p>		PIL01CM(X)*	0,40	<ul style="list-style-type: none">  Gloss White  *X = N - Gloss Black  *X = FU - Fumo  *X = TP- Talpa  Le Terre di Cielo  Le Acque di Cielo 	120,00 159,00 169,00 169,00 169,00 169,00		
 <p>Universal click/clack drain in BRONZE with ceramic lid Válvula universal click/clack Bronce con tapa en cerámica / Bonde / Universal-Ablaufgarnitur Click-Clack Bronze mit Keramikstopfen / Универсальный донный клапан click/clack бронза с керамической крышкой</p>		PIL01BR(X)*	0,40	<ul style="list-style-type: none">  Gloss White  *X = N - Gloss Black  *X = FU - Fumo  *X = TP- Talpa  Le Terre di Cielo  Le Acque di Cielo 	135,00 171,00 182,00 182,00 182,00 182,00		

Acque di Cielo available for wc-bidet / Acque di Cielo disponibles para wc-bidet / Acque di Cielo disponibles pour cuvette-bidet / Für das WC/Bidet erhältliche Ausführungen Acque di Cielo / Отделка Acque di Cielo доступны для унитаза и биде

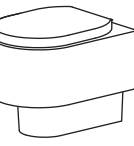
-  OL - Oltremare
-  SM - Smeraldo
-  AL - Alga
-  CO - Corallo
-  NI - Ninfea
-  AM - Anemone
-  TL - Talco
-  PM - Pomice
-  BR - Brina
-  AN - Arenaria
-  AV - Avena
-  CM - Cemento
-  LN - Lino
-  BA - Basalto
-  LV - Lavagna

* Terre di Cielo finishes available for wc-bidet / Acabados Terre di Cielo disponibles para wc-bidet / Finitions Terre di Cielo disponibles pour cuvette-bidet / Für das WC/Bidet erhältliche Ausführungen Terre di Cielo / Отделка Terre di Cielo доступны для унитаза и биде

 	Size (cm) Medidas Dimensions Maße Размеры	Product code Artículo Article Artikel Артикул	Net weight (Kg) Peso neto Poids net Reingewicht вес нетто	Finishes Acabados Finitions Farbe Отделка	Euro Евро	Pz. шт. pallet Italia	Pz. шт. pallet Cont.
 <p>Wc with horizontal outlet convertible to floor outlet by technical curve (4,5 LT) - rimless 2.0.1 Wc con desagüe a pared convertible a suelo con curva técnica (4,5 LT) - sin brida - rimless 2.0.1 \ wc avec évacuation murale transformable à terre avec courbe technique (4,5L) - sans bride - rimless 2.0.1 \ WC mit Wandabfluss, durch Kurventechnik auf Bodenabfluss umrüstbar (4,5 LT) - ohne Spülrand - rimless 2.0.1 \ Слив в стену при помощи технического колена трансформируется на слив в пол (4,5 л) - без ободка - rimless 2.0.1</p>	56 x 39 x h42	OTVAK(X)*	28,50	<ul style="list-style-type: none"> Gloss White 473,00 *X = TL - Talco 616,00 *X = N - Gloss Black 693,00 *X = FU - Fumo 693,00 *X = TP - Talpa 693,00 Le Terre di Cielo * 693,00 Le Acque di Cielo 693,00 			
<p>QUICK RELEASE HINGES </p>  <p>Thermosetting seat & cover Asiento para inodoro Abattant thermodurcissable Wc-sitz thermodur Сиденье из термоотверждающейся смолы</p>		CPVOTT(X)*		<ul style="list-style-type: none"> Gloss White 110,00 			
<p>QUICK RELEASE HINGES </p>  <p>Thermosetting soft close seat & cover Asiento para inodoro amortiguado Abattant thermodurcissable soft Wc-sitz thermodur mit Abs. Сиденье из термоотверждающейся смолы с плавным опусканием</p>		CPVOTT(X)*		<ul style="list-style-type: none"> Gloss White 188,00 *X = TL - Talco 296,00 *X = N - Gloss Black 316,00 *X = FU - Fumo 316,00 *X = TP - Talpa 316,00 Le Terre di Cielo * 316,00 Le Acque di Cielo 316,00 			

Technical symbols legend *Símbolos técnicos clave | Légende symboles techniques | Technische Zeichenerklärung | Перечень технических символов*







-  **back to wall installation**
instalación a suelo /
 installation à terre /
 bodenstehende Montage
 напольная установка
-  **with fixing parts**
 fijaciones incluidas /
 fixations incluses /
 inklusive Befestigungen
 в комплекте с
 крепежами
-  **4,5 L toilet tank**
 descarga 4,5 lt /
 évacuation à 4,5 l
 4,5 l-Spülung / бак
 на 4,5 л
-  **bifunctional drain**
 descarga bifuncional /
 évacuation bifonctionnelle
 Spülung mit zwei
 Montagevarianten /
 ункциональный бак
-  **quick release hinge**
 sistema extraíble /
 charnières à ouverture
 Takeoff Funktion /
 быстрый сьем
-  **with overflow**
 con rebosadero /
 avec trop-plein / mit
 Überlauf / с переливом
-  **one tap hole**
 con 1 agujero / monotrou /
 1-Loch / одно отверстие
 под смеситель

- Acque di Cielo available for wc-bidet** / *Acque di Cielo disponibles para wc-bidet | Acque di Cielo disponibles pour cuvette-bidet | Für das WC/Bidet erhältliche Ausführungen Acque di Cielo | Отделка Acque di Cielo доступны для унитаза и биде*
- -
 -
 -
 -
 -
- * Terre di Cielo finishes available for wc-bidet** / *Acabados Terre di Cielo disponibles para wc-bidet | Finitions Terre di Cielo disponibles pour cuvette-bidet | Für das WC/Bidet erhältliche Ausführungen Terre di Cielo | отделка Terre di Cielo доступны для унитаза и биде*
- -
 -
 -
 -
 -
 -
 -
 -

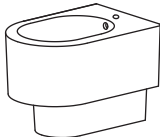
Otis - bidet

Can be ordered from January 2025
 On peut le commander à partir de Janvier 2025
 Disponible para pedir a partir de Enero del 2025
 lieferbar ab Januar 2025
 доступно к заказу с январь 2025

cielo

	Size (cm)	Product code	Net weight (Kg)	Finishes	Euro	Pz.	Pz.
	Medidas Dimensions Maße Размеры	Artículo Article Artikel Артикул	Peso neto Poids net Reingewicht вес нетто	Acabados Finitions Farbe Отделки	Евро	шт. pallet Italia	шт. pallet Cont.
 <p>Back to wall one hole bidet Bidé a suelo monoagujero Bidet monotrou Stand-Bidet einloch Биде напольное с одним отверстием под смеситель</p>	56 x 39 x h42	OTBI(X)*	27,00	● Gloss White ● *X = TL - Talco ● *X = N - Gloss Black ● *X = FU - Fumo ● *X = TP - Talpa ● Le Terre di Cielo * ● Le Acque di Cielo	451,00 561,00 649,00 649,00 649,00 649,00		
 <p>Impact and acoustic protection panel / Protección antigolpes y acústica / Protection acoustique et anti-choc / Stoss- und Schalldämmung / Противоударная и акустическая защита</p>		PAA	0,16		17,00		
 <p>Couple of fixing brackets for wall-hung wc/bidet - Pareja de estribo para Inodoro/Bidet suspendido / Étriers de fixation pour Wc/Bidet suspendus / 1 Paar Halterungen für wandhängendes Wc/Bidet / Монтажная рама для подвешенного унитаза/биде</p>	3,3 x 18,5 x 55 h	508	2,00		39,00		
 <p>Universal click/clack drain in CHROME with ceramic lid Válvula universal click/clack Cromado con tapa en cerámica / Bonde universelle clic/clac Chromé avec clapet en céramique / Universal-Ablaufgarnitur Click-Clack Chrom mit Keramikstopfen / Универсальный донный клапан click/clack хром с керамической крышкой</p>		PIL01(X)*	0,40	● Gloss White ● *X = N - Gloss Black ● *X = FU - Fumo ● *X = TP - Talpa ● Le Terre di Cielo ● Le Acque di Cielo	95,00 114,00 139,00 139,00 139,00 139,00		
 <p>Universal click/clack drain in BLACK MATT finish with ceramic lid Válvula universal click/clack Negro Matt con tapa en cerámica / Bonde universelle clic/clac Noir Mat avec clapet en céramique / Universal-Ablaufgarnitur Click-Clack Matt Schwarz mit Keramikstopfen / Универсальный донный клапан click/clack черный матовый с керамической крышкой</p>		PIL01NM(X)*	0,40	● Gloss White ● *X = N - Gloss Black ● *X = FU - Fumo ● *X = TP - Talpa ● Le Terre di Cielo ● Le Acque di Cielo	120,00 159,00 169,00 169,00 169,00 169,00		
 <p>Universal click/clack drain in CEMENTO finish with ceramic lid Válvula universal click/clack Cemento con tapa en cerámica / Bonde universelle clic/clac Cimento avec clapet en céramique / Universal-Ablaufgarnitur Click-Clack Cement mit Keramikstopfen / Универсальный донный Cimento click/clack с керамической крышкой</p>		PIL01CM(X)*	0,40	● Gloss White ● *X = N - Gloss Black ● *X = FU - Fumo ● *X = TP - Talpa ● Le Terre di Cielo ● Le Acque di Cielo	120,00 159,00 169,00 169,00 169,00 169,00		
 <p>Universal click/clack drain in BRONZE with ceramic lid Válvula universal click/clack Bronce con tapa en cerámica / Bonde / Universal-Ablaufgarnitur Click-Clack Bronze mit Keramikstopfen / Универсальный донный клапан click/clack бронза с керамической крышкой</p>		PIL01BR(X)*	0,40	● Gloss White ● *X = N - Gloss Black ● *X = FU - Fumo ● *X = TP - Talpa ● Le Terre di Cielo ● Le Acque di Cielo	135,00 171,00 182,00 182,00 182,00 182,00		

Acque di Cielo available for wc-bidet / Acque di Cielo disponibles para wc-bidet / Acque di Cielo disponibles pour cuvette-bidet / Für das WC/ Bidet erhältliche Ausführungen Acque di Cielo / Отделку Acque di Cielo доступны для унитаза и биде

* Terre di Cielo finishes available for wc-bidet / Acabados Terre di Cielo disponibles para wc-bidet / Finitions Terre di Cielo disponibles pour cuvette-bidet / Für das WC/Bidet erhältliche Ausführungen Terre di Cielo / отделку Terre di Cielo доступны для унитаза и биде

- OL - Oltremare
- SM - Smeraldo
- AL - Alga
- CO - Corallo
- NI - Ninfea
- AM - Anemone
- TL - Talco
- PM - Pomice
- BR - Brina
- AN - Arenaria
- AV - Avena
- CM - Cemento
- LN - Lino
- BA - Basalto
- LV - Lavagna

	Product code Artículo Article Artikel Артикул	Net weight(Kg) Peso neto Poids net Reingewicht вес нетто	Finishes Acabados Finitions Farbe Отделки	Euro Евро
 <p>Straight pan connector for wall trap Anclaje a pared para inodoro / Pipe pour sortie horizontale / WC-Anschlussstutzen für Abgang waagerecht / Фитинг для выпуска в стену для унитазов</p>	RPB	0,35		15,00
 <p>Off-centre connection 5 cm for wall drainage Conexión excéntrica 5 cm. para desagüe a pared. Raccord excentrique 5 cm max pour l'évacuation au mur. Anschlussstück exzentrisch, 5 cm, für Spülkasten in Wand. Соединение эксцентрик 5 см для слива в стену.</p>	RSE5		● Glossy Black	36,00
 <p>Off-centre connection max ± 4 cm for ground drainage Conexión excéntrica máx ± 4 cm. para desagüe a suelo. Raccord excentrique ± 4 cm max pour l'évacuation au sol. Anschlussstück exzentrisch, max. ± 4 cm, für oder Standausführung. Соединение эксцентрик макс ± 4 см для слива в пол.</p>	RSE4			30,00
 <p>Off-centre connection max ± 2 cm for ground drainage Conexión excéntrica máx ± 2 cm. para desagüe a suelo. Raccord excentrique ± 2 cm max pour l'évacuation au sol. Anschlussstück exzentrisch, max. ± 2 cm, für oder Standausführung. Соединение эксцентрик макс ± 2 см для слива в пол.</p>	RSE2			22,00
 <p>High technical S-bend for floor drainage Curva tecnica a "S" alta para descarga a suelo. Courbe technique haute en « S » pour l'évacuation au sol. "S"-Rohrbogen, hoch, für Spülkasten in Standausführung. Техническая трубка «S» высокая для слива в пол.</p>	CSTR27			43,00
 <p>Compact high technical S-bend Curva tecnica a "S" alta compacta. Courbe technique haute et compacte en « S ». "S"-Rohrbogen, hoch, kompakt. Компактная техническая трубка «S».</p>	CSB27			26,00
 <p>Technical bend adjustable Curva técnica ajustable Courbe technique réglable Einstellbare technische Kurve Регулируемая техническая кривая</p>	CRR			



Itaca

design Luca Cimarra

indice collezione \ collection index pg. 46 - 49





modulo d'ordine \ order form pg. 52 - 61

listino prezzi \ price list pg. 62 - 84

Washbasins finishes

Acabados de Lavabos \ Finitions des Lavabos \ Waschbecken Farbe \ Отделки Раковина

Essential Colours

-  Gloss White
-  Gloss Black
-  FU - Fumo **NEW**
-  TP - Talpa **NEW**

Le Terre di Cielo

-  TL - Talco
-  PM - Pomice
-  BR - Brina
-  CM - Cemento
-  BA - Basalto
-  LV - Lavagna
-  FN - Fango
-  CA - Cacao
-  AN - Arenaria
-  AV - Avena
-  MU - Muschio
-  AG - Agave
-  LN - Lino
-  CN - Canapa
-  CP - Cipria
-  PL - Polvere

Le Acque di Cielo

-  OL - Oltremare
-  SM - Smeraldo
-  AL - Alga
-  CO - Corallo
-  NI - Ninfea
-  AM - Anemone

WC and Bidets finishes

Acabados de Sanitarios \ Finitions des WC et Bidets \ WC und Bidet Farbe \ Отделки Унитаз и Биде

Essential Colours

-  Gloss White
-  Gloss Black
-  FU - Fumo **NEW**
-  TP - Talpa **NEW**

Le Terre di Cielo

-  TL - Talco
-  PM - Pomice
-  LN - Lino
-  BR - Brina
-  AV - Avena
-  AN - Arenaria
-  CM - Cemento
-  BA - Basalto
-  LV - Lavagna

Le Acque di Cielo

-  OL - Oltremare
-  SM - Smeraldo
-  AL - Alga
-  CO - Corallo
-  NI - Ninfea
-  AM - Anemone

Cabinet finishes

Acabados para mueble \ finitions pour le meuble | Für Möbel Farbe | отделка доступна для ящика

Essential Colours

-  FU - Fumo **NEW**
-  TP - Talpa **NEW**

Le Terre di Cielo

-  TL - Talco
-  PM - Pomice
-  BR - Brina
-  CM - Cemento
-  BA - Basalto
-  AN - Arenaria
-  AV - Avena
-  MU - Muschio
-  AG - Agave **NEW**

Essenze

-  RS - Rovere Sbiancato
-  RN - Rovere Naturale
-  RG - Rovere Nero
-  RT - Rovere Tinto Noce **NEW**
-  EU - Eucalipto

Le Acque di Cielo

-  OL - Oltremare
-  SM - Smeraldo
-  AL - Alga
-  CO - Corallo
-  NI - Ninfea
-  AM - Anemone

The possible variations of the colour cannot be considered as defect, but as a guarantee of the completely artisan manufacturing of this unique and high quality product. / Las variaciones de colores no se consideran un defecto sino una garantía de una elaboración manual y artesanal en un producto único y de calidad. / Les éventuelles variations de couleur ne peuvent être considérées comme des défauts, elles témoignent en revanche d'une méthode de travail totalement manuelle et artisanale employée pour obtenir un produit fini unique et de qualité. / Eventuelle Farbvariationen sind nicht als Mangel anzusehen, sondern als Garantie für die komplett handwerkliche Anfertigung eines einzigartigen und hochqualitativen Produkts. / Возможные вариации цвета не могут считаться дефектом, а являются подтверждением ручной работы, гарантией качества и уникальности изделия.

Lavabi / washbasins

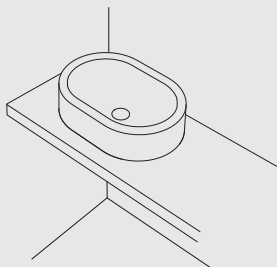

ITLAO
66 x 46 x 18 h
pg. 62

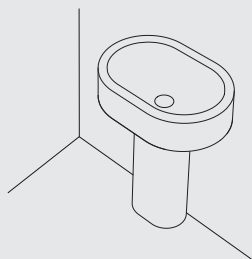

ITLAO/ITCOLC/ITCOLP
66 x 46 x 85 h
pg. 62

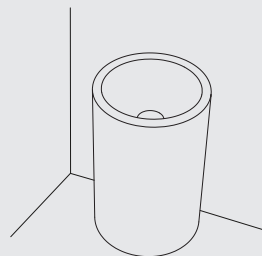

ITFREEC/ITFREEP
ø 53 x 85 h
pg. 66

Wc - bidet

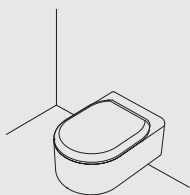

ITVSK
53 x 37 x 26 h
pg. 78

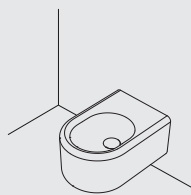

ITBS
53 x 37 x 26 h
pg. 79

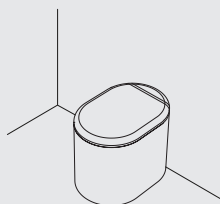

ITVAK
53 x 37 x 42 h
pg. 80

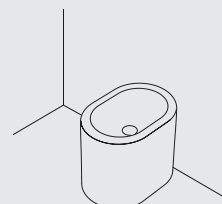

ITBI
53 x 37 x 42 h
pg. 81

CIELO RIMLESS 2.0.1®

CIELO RIMLESS 2.0.1®

Lavabi con mobili / washbasins with cabinet

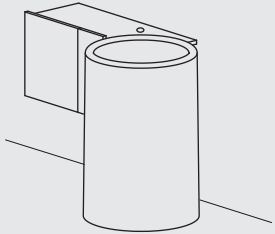

lavabo freestanding con mobile Itaca sospeso 90 sinistro

Itaca freestanding washbasin with left side suspended cabinet 90
mobile\cabinet: cm 87 x 33,5 x 42,5 h
pg. 68

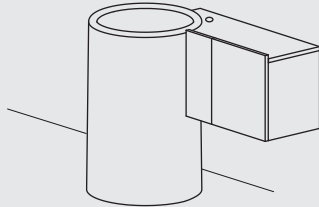

lavabo freestanding con mobile Itaca sospeso 90 destro

Itaca freestanding washbasin with right side suspended cabinet 90
mobile\cabinet: cm 87 x 33,5 x 42,5 h
pg. 68

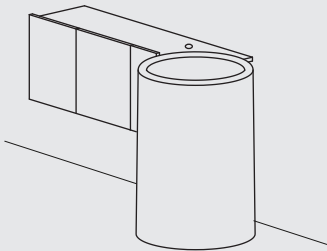

lavabo freestanding con mobile Itaca sospeso 128 sinistro

Itaca freestanding washbasin with left side suspended cabinet 128
mobile\cabinet: cm 125 x 33,5 x 42,5 h
pg. 70

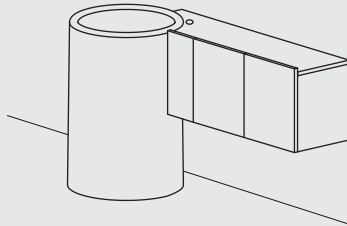

lavabo freestanding con mobile Itaca sospeso 128 destro

Itaca freestanding washbasin with right side suspended cabinet 128
mobile\cabinet: cm 125 x 33,5 x 42,5 h
pg. 70

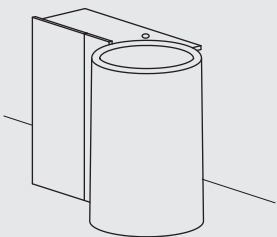

lavabo freestanding con mobile Itaca a terra 90 sinistro

Itaca freestanding washbasin with left side floor-standing cabinet 90
mobile\cabinet: cm 87 x 33,5 x 85 h
pg. 72

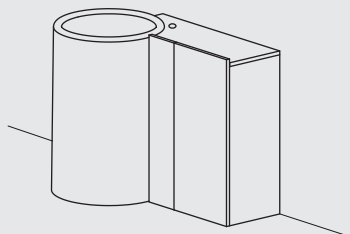

lavabo freestanding con mobile Itaca a terra 90 destro

Itaca freestanding washbasin with right side floor-standing cabinet 90
mobile\cabinet: cm 87 x 33,5 x 85 h
pg. 72

The possible variations of the colour cannot be considered as defect, but as a guarantee of the completely artisan manufacturing of this unique and high quality product. / Las variaciones de colores no se consideran un defecto sino una garantía de una elaboración manual y artesanal en un producto único y de calidad. / Les éventuelles variations de couleur ne peuvent être considérées comme des défauts, elles témoignent en revanche d'une méthode de travail totalement manuelle et artisanale employée pour obtenir un produit fini unique et de qualité. / Eventuelle Farbvariationen sind nicht als Mangel anzusehen, sondern als Garantie für die komplett handwerkliche Anfertigung eines einzigartigen und hochqualitativen Produkts. / Возможные вариации цвета не могут считаться дефектом, а являются подтверждением ручной работы, гарантией качества и уникальности изделия.

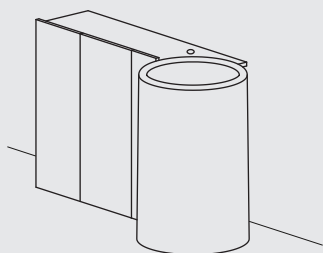

lavabo freestanding con mobile Itaca a terra

128 sinistro

Itaca freestanding washbasin with left side floor-standing cabinet 128

mobile\cabinet: cm 125 x 33,5 x 85 h

pg. 74

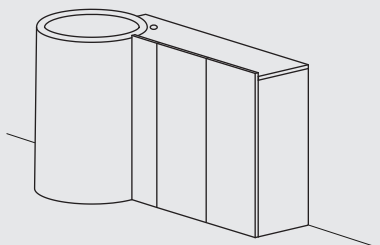

lavabo freestanding con mobile Itaca a terra

128 destro

Itaca freestanding washbasin with right side floor-standing cabinet 128

mobile\cabinet: cm 125 x 33,5 x 85 h

pg. 74

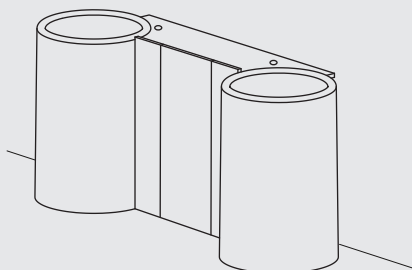

lavabo freestanding con mobile Itaca a terra

centrale

Itaca freestanding washbasin with central floor-standing cabinet

mobile\cabinet: cm 135 x 33,5 x 85 h

pg. 76





modelli disponibili / available models

ITACA
collection

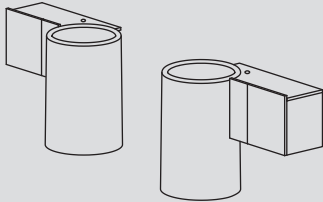

**Itaca lavabo freestanding con mobile
sospeso 90 sinistro / destro**
Itaca freestanding washbasin with
wall-hung cabinet 90 left / right version



finiture / finishes

LAVABO IN CERAMICA / CERAMIC WASHBASIN



ITFREEP
ITFREEC

Le Terre di Cielo

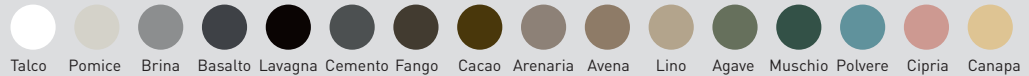

Le Acque di Cielo



Essential colors

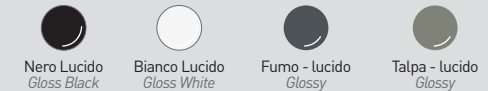

MOBILE IN LEGNO / WOODEN CABINET

laccature / lacquers

Le Terre di Cielo



Le Acque di Cielo



essenze / wooden finishes

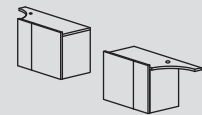

ITMS90SXL - ITMS90DXL
ITMS90SXE - ITMS90DXE

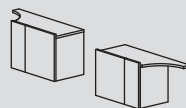

ITMS90SXL SF - ITMS90SXESF
ITMS90DXL SF - ITMS90DXESF

note tecniche lavabo / washbasin technical notes

con troppopieno
with overflow

con tutti i lati smaltati
all enamelled sides

**installazione freestanding
scarico parete**
*freestanding installation, wall
trap*

**installazione freestanding
centro stanza**
*room centre freestanding
installation*

senza foro
without hole

Modulo Ordine Itaca mobile sospeso 90

Itaca wall-hung cabinet 90 Order Form

cielo

CLIENTE/client: ORD. REF.:

QUANTITA'/quantity: EMAIL:

INDICARE CON UN SEGNO LE FINITURE SCELTE PER I DIVERSI COMPONENTI

INDICATE WITH A TICK, THE CHOSEN FINISHES FOR ALL THE COMPONENTS

art. **ITFREEP**
art. **ITFREEC**

FINITURE LAVABO
WASHBASIN FINISHES

Essential Colors

- Bianco/white - glossy
- N - Nero/black - glossy
- FU - Fumo - glossy
- TP - Talpa - glossy

Le Terre di Cielo

<input type="radio"/> TL - Talco	<input type="radio"/> AN - Arenaria
<input type="radio"/> PM - Pomice	<input type="radio"/> AV - Avena
<input type="radio"/> BR - Brina	<input type="radio"/> LN - Lino
<input type="radio"/> BA - Basalto	<input type="radio"/> AG - Agave
<input type="radio"/> LV - Lavagna	<input type="radio"/> MU - Muschio
<input type="radio"/> CM - Cemento	<input type="radio"/> PL - Polvere
<input type="radio"/> FN - Fango	<input type="radio"/> CP - Cipria
<input type="radio"/> CA - Cacao	<input type="radio"/> CN - Canapa

Le Acque di Cielo

<input type="radio"/> OL - Oltremare	<input type="radio"/> CO - Corallo
<input type="radio"/> SM - Smeraldo	<input type="radio"/> NI - Ninfea
<input type="radio"/> AL - Alga	<input type="radio"/> AM - Anemone

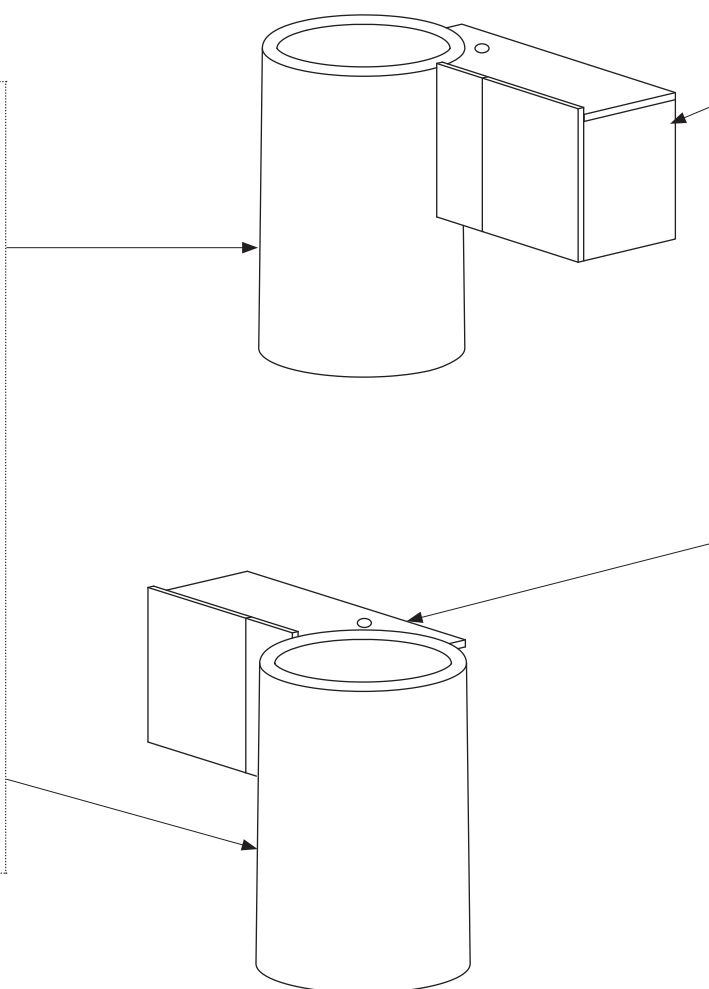

DESTRO / RIGHT

art. **ITMS90DXL** (laccato/laquer)
art. **ITMS90DXLSF** (laccato senza foro/laquer without hole)
art. **ITMS90DXE** (essenza/essence)
art. **ITMS90DXESF** (essenza senza foro/essence without hole)

FINITURE MOBILE IN LEGNO

WOODEN CABINET FINISHES

laccature/laquerings

- | | |
|-------------------------------------|------------------------------------|
| <input type="radio"/> TL - Talco | <input type="radio"/> AV - Avena |
| <input type="radio"/> PM - Pomice | <input type="radio"/> CM - Cemento |
| <input type="radio"/> BR - Brina | <input type="radio"/> BA - Basalto |
| <input type="radio"/> AN - Arenaria | <input type="radio"/> MU - Muschio |
| <input type="radio"/> AG - Agave | |

Le Acque di Cielo

- | | |
|--------------------------------------|------------------------------------|
| <input type="radio"/> OL - Oltremare | <input type="radio"/> CO - Corallo |
| <input type="radio"/> SM - Smeraldo | <input type="radio"/> NI - Ninfea |
| <input type="radio"/> AL - Alga | <input type="radio"/> AM - Anemone |

- FU - Fumo
- TP - Talpa

essenze legno/wood essences

- R0 - Rovere Nero
- RT - Rovere Tinto noce
- RS - Rovere Sbiancato
- RN - Rovere Naturale
- EU - Eucalipto

SINISTRO \ LEFT

art. **ITMS90SXL** (laccato/laquer)
art. **ITMS90SXLFSF** (laccato senza foro/laquer without hole)
art. **ITMS90SXE** (essenza/essence)
art. **ITMS90SXESF** (essenza senza foro/essence without hole)

DATA
DATE

FIRMA DEL CLIENTE
SIGNATURE

ATTENZIONE:
La rappresentazione delle finiture è puramente indicativa. Verificare le finiture con le relative cartelle.

Ogni oggetto possiede la peculiarità di essere elaborato secondo principi puramente tradizionali, in modo da garantirne l'assoluta originalità ed unicità. Le eventuali piccole variazioni di colore, tono o venature fra gli articoli sono da considerarsi pregi e non difetti, in quanto garanzia della fattura manuale del prodotto, che fa di ogni oggetto Cielo un pezzo unico ed esclusivo, lontano dall'omologazione industriale. In fase d'ordine si intendono, pertanto, accettate tali tolleranze che non possono dare adito a contestazioni di alcun genere.

Verificare sempre le disponibilità e i tempi di consegna con il commerciale.

ATTENTION:
The representation of the finishes is merely indicative. Please choose the finishes using the folders.

Every item possesses that particular feature of being processed according to purely traditional principles that guarantee its absolute originality and uniqueness. The small variations in colour, hues or streaks on the items are to be considered as qualities and not defects, since they warranty the handcrafted processing which makes each Cielo item a unique and exclusive piece that cannot be compared to industrial standardization. When making the order, the client implicitly accepts those various features that may give rise to claims of any sort.

Always check the availability and delivery time with the commercial department.

modelli disponibili / available models

ITACA
collection

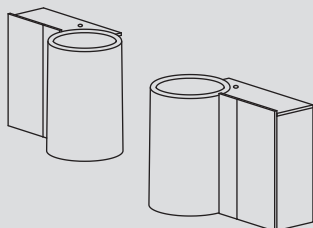

Itaca lavabo freestanding con mobile a terra 90 sinistro / destro
Itaca freestanding washbasin with on the floor cabinet 90 left / right version



finiture / finishes

LAVABO IN CERAMICA / CERAMIC WASHBASIN



ITFREEP
ITFREEC

Le Terre di Cielo

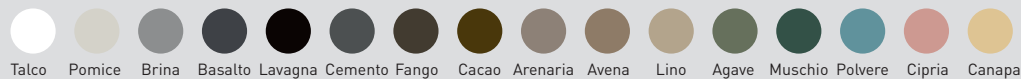

Le Acque di Cielo



Essential colors



MOBILE IN LEGNO / WOODEN CABINET

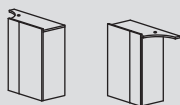

ITMT90SXL - ITMT90SXE
ITMT90DXL - ITMT90DXE

laccature / lacquers

Le Terre di Cielo



Le Acque di Cielo

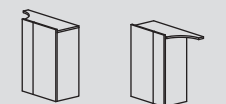

ITMT90SXL - ITMT90SXE
ITMT90DXL - ITMT90DXE

essenze / wooden finishes

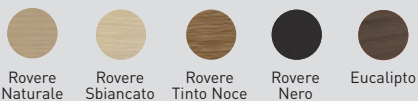

note tecniche lavabo / washbasin technical notes

con troppopieno
with overflow

con tutti i lati smaltati
all enamelled sides

installazione freestanding scarico parete
freestanding installation, wall trap

installazione freestanding centro stanza
room centre freestanding installation

senza foro
without hole

Modulo Ordine Itaca mobile a terra 90

Itaca on the floor cabinet 90 Order Form

cielo

CLIENTE/client: ORD. REF.:

QUANTITA'/quantity: EMAIL:

INDICARE CON UN SEGNO LE FINITURE SCELTE PER I DIVERSI COMPONENTI

INDICATE WITH A TICK, THE CHOOSEN FINISHES FOR ALL THE COMPONENTS

art. **ITFREEP**
art. **ITFREEC**

FINITURE LAVABO
WASHBASIN FINISHES

Essential Colors

- Bianco/white - glossy
- N - Nero/black - glossy
- FU - Fumo - glossy
- TP - Talpa - glossy

Le Terre di Cielo

<input type="radio"/> TL - Talco	<input type="radio"/> AN - Arenaria
<input type="radio"/> PM - Pomice	<input type="radio"/> AV - Avena
<input type="radio"/> BR - Brina	<input type="radio"/> LN - Lino
<input type="radio"/> BA - Basalto	<input type="radio"/> AG - Agave
<input type="radio"/> LV - Lavagna	<input type="radio"/> MU - Muschio
<input type="radio"/> CM - Cemento	<input type="radio"/> PL - Polvere
<input type="radio"/> FN - Fango	<input type="radio"/> CP - Cipria
<input type="radio"/> CA - Cacao	<input type="radio"/> CN - Canapa

Le Acque di Cielo

<input type="radio"/> OL - Oltremare	<input type="radio"/> CO - Corallo
<input type="radio"/> SM - Smeraldo	<input type="radio"/> NI - Ninfea
<input type="radio"/> AL - Alga	<input type="radio"/> AM - Anemone

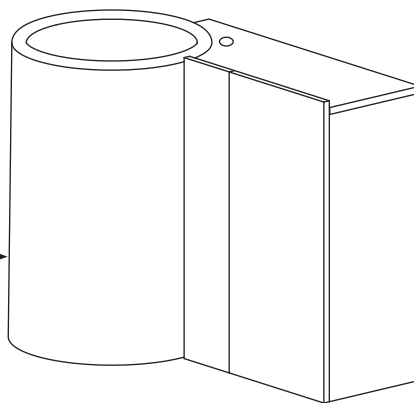

DESTRO / RIGHT

art. **ITMT90DXL** (laccato/laquered)
art. **ITMT90DXLSF** (laccato senza foro/laquered without hole)
art. **ITMT90DXE** (essenza/essence)
art. **ITMT90DXESF** (essenza senza foro/essence without hole)

FINITURE MOBILE IN LEGNO

WOODEN CABINET FINISHES

laccature/laquerings

- | | |
|-------------------------------------|------------------------------------|
| <input type="radio"/> TL - Talco | <input type="radio"/> AV - Avena |
| <input type="radio"/> PM - Pomice | <input type="radio"/> CM - Cemento |
| <input type="radio"/> BR - Brina | <input type="radio"/> BA - Basalto |
| <input type="radio"/> AN - Arenaria | <input type="radio"/> MU - Muschio |
| <input type="radio"/> AG - Agave | |

Le Acque di Cielo

- | | |
|--------------------------------------|------------------------------------|
| <input type="radio"/> OL - Oltremare | <input type="radio"/> CO - Corallo |
| <input type="radio"/> SM - Smeraldo | <input type="radio"/> NI - Ninfea |
| <input type="radio"/> AL - Alga | <input type="radio"/> AM - Anemone |

- FU - Fumo
- TP - Talpa

essenze legno/wood essences

- RO - Rovere Nero
- RT - Rovere Tinto noce
- RS - Rovere Sbiancato
- RN - Rovere Naturale
- EU - Eucalipto

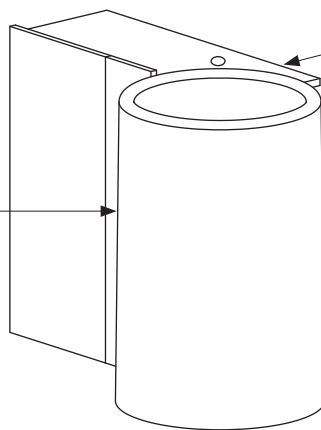

SINISTRO \ LEFT

art. **ITMT90SXL** (laccato/laquered)
art. **ITMT90SXL SF** (laccato senza foro/laquered without hole)
art. **ITMT90SXE** (essenza/essence)
art. **ITMT90SXE SF** (essenza senza foro/essence without hole)

DATA
DATE

FIRMA DEL CLIENTE
SIGNATURE

ATTENZIONE:
La rappresentazione delle finiture è puramente indicativa. Verificare le finiture con le relative cartelle.

Ogni oggetto possiede la peculiarità di essere elaborato secondo principi puramente tradizionali, in modo da garantirne l'assoluta originalità ed unicità. Le eventuali piccole variazioni di colore, tono o venature fra gli articoli sono da considerarsi pregi e non difetti, in quanto garanzia della fattura manuale del prodotto, che fa di ogni oggetto Cielo un pezzo unico ed esclusivo, lontano dall'omologazione industriale. In fase d'ordine si intendono, pertanto, accettate tali tolleranze che non possono dare adito a contestazioni di alcun genere.

Verificare sempre le disponibilità e i tempi di consegna con il commerciale.

ATTENTION:
The representation of the finishes is merely indicative. Please choose the finishes using the folders.

Every item possesses that particular feature of being processed according to purely traditional principles that guarantee its absolute originality and uniqueness. The small variations in colour, hues or streaks on the items are to be considered as qualities and not defects, since they warranty the handcrafted processing which makes each Cielo item a unique and exclusive piece that cannot be compared to industrial standardization. When making the order, the client implicitly accepts those various features that may give rise to claims of any sort.

Always check the availability and delivery time with the commercial department.

modelli disponibili / available models

ITACA
collection

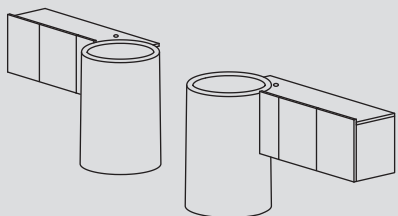

**Itaca lavabo freestanding con mobile
sospeso 128 sinistro / destro**
Itaca freestanding washbasin with
wall-hung cabinet 128 left / right version



finiture / finishes

LAVABO IN CERAMICA / CERAMIC WASHBASIN



ITFREEP
ITFREEC

Le Terre di Cielo

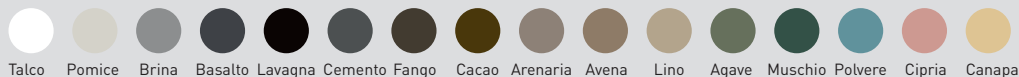

Le Acque di Cielo



Essential colors



MOBILE IN LEGNO / WOODEN CABINET

laccature / lacquers

Le Terre di Cielo



Le Acque di Cielo



essenze / wooden finishes

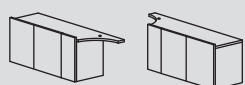
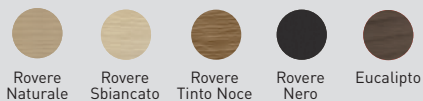

ITMS128SXL - ITMS128SXE
ITMS128DXL - ITMS128DXE

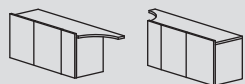

ITMS128SXL SF - ITMS128SXESF
ITMS128DXL SF - ITMS128DXESF

note tecniche lavabo / washbasin technical notes

 **con troppopieno**
with overflow

 **con tutti i lati smaltati**
all enamelled sides

 **installazione freestanding
scarico parete**
freestanding installation, wall
trap

 **installazione freestanding
centro stanza**
room centre freestanding
installation

 **senza foro**
without hole

Modulo Ordine Itaca mobile sospeso 128

Itaca wall-hung cabinet 128 Order Form

cielo

CLIENTE/client: ORD. REF.:

QUANTITA'/quantity: EMAIL:

INDICARE CON UN SEGNO LE FINITURE SCELTE PER I DIVERSI COMPONENTI

INDICATE WITH A TICK, THE CHOOSEN FINISHES FOR ALL THE COMPONENTS

art. **ITFREEP**
art. **ITFREEC**

FINITURE LAVABO

WASHBASIN FINISHES

Essential Colors

- Bianco/white - glossy
- N - Nero/black - glossy
- FU - Fumo - glossy
- TP - Talpa - glossy

Le Terre di Cielo

- TL - Talco
- PM - Pomice
- BR - Brina
- BA - Basalto
- LV - Lavagna
- CM - Cemento
- FN - Fango
- CA - Cacao
- AN - Arenaria
- AV - Avena
- LN - Lino
- AG - Agave
- MU - Muschio
- PL - Polvere
- CP - Cipria
- CN - Canapa

Le Acque di Cielo

- OL - Oltremare
- SM - Smeraldo
- AL - Alga
- CO - Corallo
- NI - Ninfea
- AM - Anemone

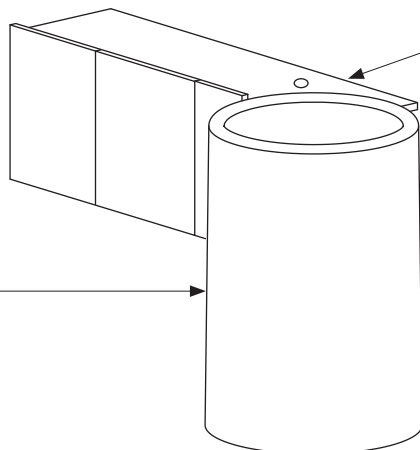
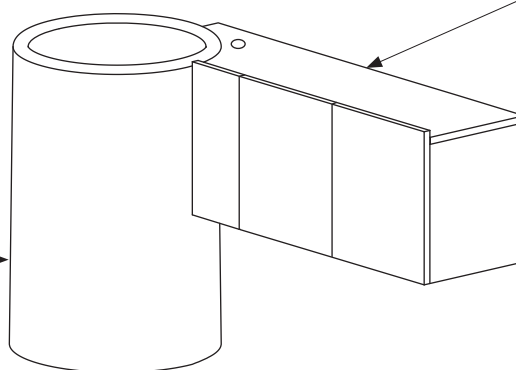

DESTRO / RIGHT

art. **ITMS128DXL** (laccato/laquered)
art. **ITMS128DXLSF** (laccato senza foro/laquered without hole)
art. **ITMS128DXE** (essenza/essence)
art. **ITMS128DXESF** (essenza senza foro/essence without hole)

FINITURE MOBILE IN LEGNO

WOODEN CABINET FINISHES

laccature/laquerings

- TL - Talco
- PM - Pomice
- BR - Brina
- AN - Arenaria
- AV - Avena
- CM - Cemento
- BA - Basalto
- MU - Muschio

Le Acque di Cielo

- OL - Oltremare
- SM - Smeraldo
- AL - Alga
- CO - Corallo
- NI - Ninfea
- AM - Anemone

- FU - Fumo
- TP - Talpa

essenze legno/wood essences

- RO - Rovere Nero
- RT - Rovere Tinto noce
- RS - Rovere Sbiancato
- RN - Rovere Naturale
- EU - Eucalipto

SINISTRO \ LEFT

art. **ITMS128SXL** (laccato/laquered)
art. **ITMS128SXLFSF** (laccato senza foro/laquered without hole)
art. **ITMS128SXE** (essenza/essence)
art. **ITMS128SXEFSF** (essenza senza foro/essence without hole)

DATA
DATE

FIRMA DEL CLIENTE
SIGNATURE

ATTENZIONE:
La rappresentazione delle finiture è puramente indicativa. Verificare le finiture con le relative cartelle.

Ogni oggetto possiede la peculiarità di essere elaborato secondo principi puramente tradizionali, in modo da garantirne l'assoluta originalità ed unicità. Le eventuali piccole variazioni di colore, tono o venature fra gli articoli sono da considerarsi pregi e non difetti, in quanto garanzia della fattura manuale del prodotto, che fa di ogni oggetto Cielo un pezzo unico ed esclusivo, lontano dall'omologazione industriale. In fase d'ordine si intendono, pertanto, accettate tali tolleranze che non possono dare adito a contestazioni di alcun genere.

Verificare sempre le disponibilità e i tempi di consegna con il commerciale.

ATTENTION:
The representation of the finishes is merely indicative. Please choose the finishes using the folders.

Every item possesses that particular feature of being processed according to purely traditional principles that guarantee its absolute originality and uniqueness. The small variations in colour, hues or streaks on the items are to be considered as qualities and not defects, since they warranty the handcrafted processing which makes each Cielo item a unique and exclusive piece that cannot be compared to industrial standardization. When making the order, the client implicitly accepts those various features that may give rise to claims of any sort.

Always check the availability and delivery time with the commercial department.

modelli disponibili / available models

ITACA collection

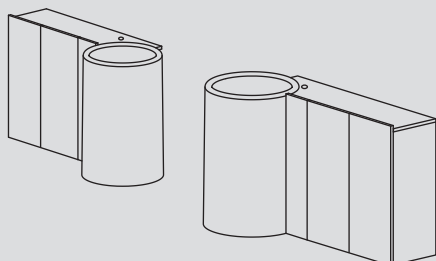

Itaca lavabo freestanding con mobile a terra 128 sinistro / destro
Itaca freestanding washbasin with on the floor cabinet 128 left / right version



finiture / finishes

LAVABO IN CERAMICA / CERAMIC WASHBASIN



ITFREEP
ITFREEC

Le Terre di Cielo

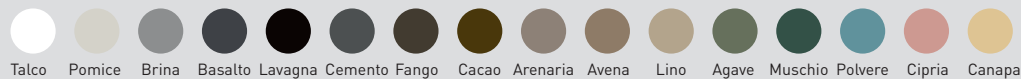

Le Acque di Cielo



Essential colors



MOBILE IN LEGNO / WOODEN CABINET

laccature / lacquers

Le Terre di Cielo



Le Acque di Cielo



essenze / wooden finishes

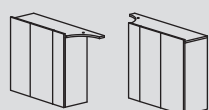
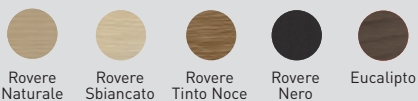

ITMT128SXL - ITMT128SXE
ITMT128DXL - ITMT128DXE

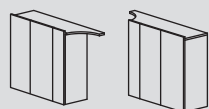

ITMT128SXL SF - ITMT128SXESF
ITMT128DXL SF - ITMT128DXESF

note tecniche lavabo / washbasin technical notes



con troppopieno
with overflow



con tutti i lati smaltati
all enamelled sides



installazione freestanding scarico parete
freestanding installation, wall trap



installazione freestanding centro stanza
room centre freestanding installation



senza foro
without hole

Modulo Ordine Itaca mobile a terra 128

Itaca on the floor cabinet 128 Order Form

cielo

CLIENTE/client: ORD. REF.:

QUANTITA'/quantity: EMAIL:

INDICARE CON UN SEGNO LE FINITURE SCELTE PER I DIVERSI COMPONENTI

INDICATE WITH A TICK, THE CHOSEN FINISHES FOR ALL THE COMPONENTS

art. **ITFREEP**
art. **ITFREEC**

FINITURE LAVABO

WASHBASIN FINISHES

Essential Colors

- Bianco/white - glossy
- N - Nero/black - glossy
- FU - Fumo - glossy
- TP - Talpa - glossy

Le Terre di Cielo

- TL - Talco
- PM - Pomice
- BR - Brina
- BA - Basalto
- LV - Lavagna
- CM - Cemento
- FN - Fango
- CA - Cacao
- AN - Arenaria
- AV - Avena
- LN - Lino
- AG - Agave
- MU - Muschio
- PL - Polvere
- CP - Cipria
- CN - Canapa

Le Acque di Cielo

- OL - Oltremare
- SM - Smeraldo
- AL - Alga
- CO - Corallo
- NI - Ninfea
- AM - Anemone

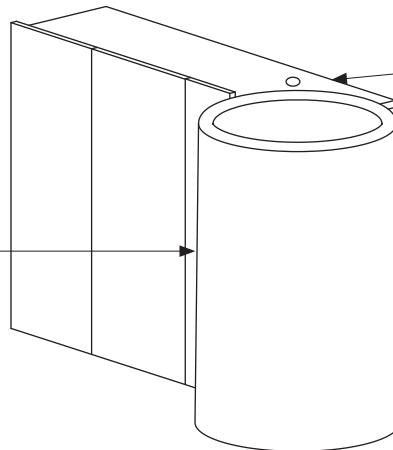
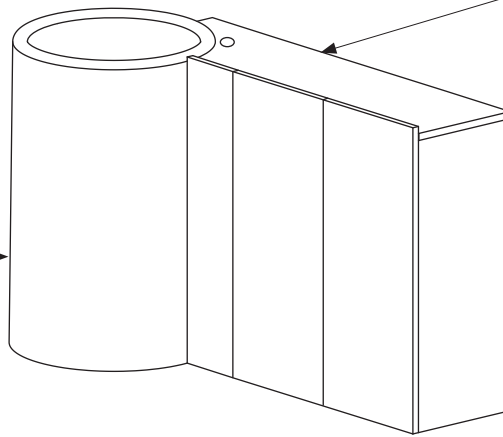

DESTRO / RIGHT

- art. **ITMT128DXL** (laccato/laquered)
- art. **ITMT128DXLSF** (laccato senza foro/laquered without hole)
- art. **ITMT128DXE** (essenza/essence)
- art. **ITMT128DXESF** (essenza senza foro/essence without hole)

FINITURE MOBILE IN LEGNO

WOODEN CABINET FINISHES

laccature/laquerings

- TL - Talco
- PM - Pomice
- BR - Brina
- AN - Arenaria
- AV - Avena
- CM - Cemento
- BA - Basalto
- MU - Muschio
- AG - Agave

Le Acque di Cielo

- OL - Oltremare
- SM - Smeraldo
- AL - Alga
- CO - Corallo
- NI - Ninfea
- AM - Anemone

- FU - Fumo
- TP - Talpa

essenze legno/wood essences

- RO - Rovere Nero
- RT - Rovere Tinto noce
- RS - Rovere Sbiancato
- RN - Rovere Naturale
- EU - Eucalipto

SINISTRO \ LEFT

- art. **ITMT128SXL** (laccato/laquered)
- art. **ITMT128SXLFSF** (laccato senza foro/laquered without hole)
- art. **ITMT128SXE** (essenza/essence)
- art. **ITMT128SXEFSF** (essenza senza foro/essence without hole)

DATA
DATE

FIRMA DEL CLIENTE
SIGNATURE

ATTENZIONE:
La rappresentazione delle finiture è puramente indicativa. Verificare le finiture con le relative cartelle.

Ogni oggetto possiede la peculiarità di essere elaborato secondo principi puramente tradizionali, in modo da garantirne l'assoluta originalità ed unicità. Le eventuali piccole variazioni di colore, tono o venature fra gli articoli sono da considerarsi pregi e non difetti, in quanto garanzia della fattura manuale del prodotto, che fa di ogni oggetto Cielo un pezzo unico ed esclusivo, lontano dall'omologazione industriale. In fase d'ordine si intendono, pertanto, accettate tali tolleranze che non possono dare adito a contestazioni di alcun genere.

Verificare sempre le disponibilità e i tempi di consegna con il commerciale.

ATTENTION:
The representation of the finishes is merely indicative. Please choose the finishes using the folders.

Every item possesses that particular feature of being processed according to purely traditional principles that guarantee its absolute originality and uniqueness. The small variations in colour, hues or streaks on the items are to be considered as qualities and not defects, since they warranty the handcrafted processing which makes each Cielo item a unique and exclusive piece that cannot be compared to industrial standardization. When making the order, the client implicitly accepts those various features that may give rise to claims of any sort.

Always check the availability and delivery time with the commercial department.

modelli disponibili / available models

ITACA
collection

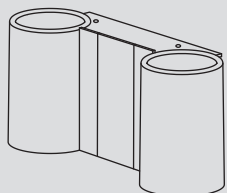

Itaca lavabo freestanding con mobile a terra centrale
Itaca freestanding washbasin with central cabinet



finiture / finishes

LAVABO IN CERAMICA / CERAMIC WASHBASIN



ITFREEP
ITFREEC

Le Terre di Cielo

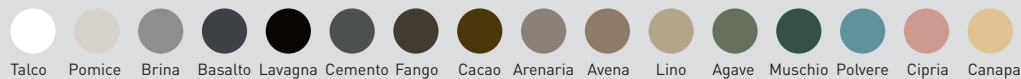

Le Acque di Cielo



Essential colors



MOBILE IN LEGNO / WOODEN CABINET

laccature / lacquers

Le Terre di Cielo



Le Acque di Cielo

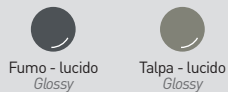

essenze / wooden finishes

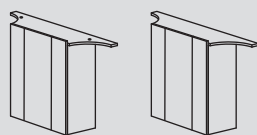
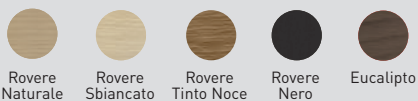

ITMTCL - ITMTCE
ITMTCLSF - ITMTCESF

note tecniche lavabo / washbasin technical notes

con troppopieno
with overflow

con tutti i lati smaltati
all enamelled sides

installazione freestanding scarico parete
freestanding installation, wall trap

installazione freestanding centro stanza
room centre freestanding installation

senza foro
without hole

Modulo Ordine Itaca mobile a terra centrale

Itaca on the floor central cabinet Order Form

cielo

CLIENTE/client: ORD. REF.:

QUANTITA'/quantity: EMAIL:

INDICARE CON UN SEGNO LE FINITURE SCELTE PER I DIVERSI COMPONENTI

INDICATE WITH A TICK, THE CHOSEN FINISHES FOR ALL THE COMPONENTS

art. **ITFREEP**
art. **ITFREEC**

art. **ITMTCL** (laccato/laquered)
art. **ITMTCLSF** (laccato senza foro/laquered without hole)
art. **ITMTCE** (essenza/essence)
art. **ITMTCESF** (essenza senza foro/essence without hole)

FINITURE LAVABO
WASHBASIN FINISHES

Essential Colors

- Bianco/white - glossy
- N - Nero/black - glossy
- FU - Fumo - glossy
- TP - Talpa - glossy

Le Terre di Cielo

<input type="radio"/> TL - Talco	<input type="radio"/> AN - Arenaria
<input type="radio"/> PM - Pomice	<input type="radio"/> AV - Avena
<input type="radio"/> BR - Brina	<input type="radio"/> LN - Lino
<input type="radio"/> BA - Basalto	<input type="radio"/> AG - Agave
<input type="radio"/> LV - Lavagna	<input type="radio"/> MU - Muschio
<input type="radio"/> CM - Cemento	<input type="radio"/> PL - Polvere
<input type="radio"/> FN - Fango	<input type="radio"/> CP - Cipria
<input type="radio"/> CA - Cacao	<input type="radio"/> CN - Canapa

Le Acque di Cielo

<input type="radio"/> OL - Oltremare	<input type="radio"/> CO - Corallo
<input type="radio"/> SM - Smeraldo	<input type="radio"/> NI - Ninfea
<input type="radio"/> AL - Alga	<input type="radio"/> AM - Anemone

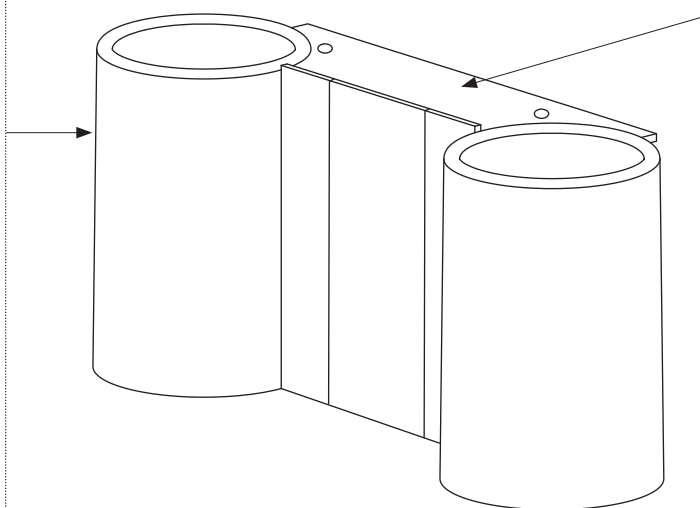

FINITURE MOBILE IN LEGNO
WOODEN CABINET FINISHES

laccature/laquerings

<input type="radio"/> TL - Talco	<input type="radio"/> AV - Avena
<input type="radio"/> PM - Pomice	<input type="radio"/> CM - Cemento
<input type="radio"/> BR - Brina	<input type="radio"/> BA - Basalto
<input type="radio"/> AN - Arenaria	<input type="radio"/> MU - Muschio
<input type="radio"/> AG - Agave	

Le Acque di Cielo

<input type="radio"/> OL - Oltremare	<input type="radio"/> CO - Corallo
<input type="radio"/> SM - Smeraldo	<input type="radio"/> NI - Ninfea
<input type="radio"/> AL - Alga	<input type="radio"/> AM - Anemone

FU - Fumo

TP - Talpa

essenze legno/wood essences

- RO - Rovere Nero
- RT - Rovere Tinto noce
- RS - Rovere Sbiancato
- RN - Rovere Naturale
- EU - Eucalipto

DATA
DATE

FIRMA DEL CLIENTE
SIGNATURE

ATTENZIONE:
La rappresentazione delle finiture è puramente indicativa. Verificare le finiture con le relative cartelle.











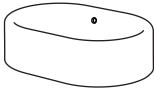













Ogni oggetto possiede la peculiarità di essere elaborato secondo principi puramente tradizionali, in modo da garantirne l'assoluta originalità ed unicità. Le eventuali piccole variazioni di colore, tono o venature fra gli articoli sono da considerarsi pregi e non difetti, in quanto garanzia della fattura manuale del prodotto, che fa di ogni oggetto Cielo un pezzo unico ed esclusivo, lontano dall'omologazione industriale. In fase d'ordine si intendono, pertanto, accettate tali tolleranze che non possono dare adito a contestazioni di alcun genere.





































Verificare sempre le disponibilità e i tempi di consegna con il commerciale.

ATTENTION:
The representation of the finishes is merely indicative. Please choose the finishes using the folders.

Every item possesses that particular feature of being processed according to purely traditional principles that guarantee its absolute originality and uniqueness. The small variations in colour, hues or streaks on the items are to be considered as qualities and not defects, since they warranty the handcrafted processing which makes each Cielo item a unique and exclusive piece that cannot be compared to industrial standardization. When making the order, the client implicitly accepts those various features that may give rise to claims of any sort.

Always check the availability and delivery time with the commercial department.

	Size (cm) Medidas Dimensions Maße Размеры	Product code Artículo Article Artikel Артикул	Net weight (Kg) Peso neto Poids net Reingewicht вес нетто	Finishes Acabados Finitions Farbe Отделки	Euro Евро	Pz. шт. pallet Italia	Pz. шт. pallet Cont.
 <p>Itaca oval on top washbasin Lavabo Itaca à poser oval Lavabo de apoio Itaca ovale Itaca Aufsatzbecken Waschtisch Oval Раковина Itaca овальный</p>	66 x 46 x h 18	ITLAO(X)*	17,50	<ul style="list-style-type: none">  Gloss White  *X = N - Gloss Black  *X = FU - Fumo  *X = TP - Talpa  Le Terre di Cielo  Le Acque di Cielo 	583,00 853,00 853,00 853,00 853,00 853,00		
 <p>Itaca wall drain pedestal Colonne avec sortie au mur Columna con salida a pared Säule mit Abgang waagrecht пьедестал со сливом в стену</p>	21 x 30 x h 67	ITCOLP(X)*	16,00	<ul style="list-style-type: none">  Gloss White  *X = N - Gloss Black  *X = FU - Fumo  *X = TP - Talpa  Le Terre di Cielo  Le Acque di Cielo 	275,00 385,00 385,00 385,00 385,00 385,00		
 <p>Itaca floor drain pedestal Colonne avec sortie au sol Columna con salida a suelo Säule mit Abgang senkrecht пьедестал со сливом в пол</p>	21 x 30 x h 67	ITCOLC(X)*	16,00	<ul style="list-style-type: none">  Gloss White  *X = N - Gloss Black  *X = FU - Fumo  *X = TP - Talpa  Le Terre di Cielo  Le Acque di Cielo 	275,00 385,00 385,00 385,00 385,00 385,00		
 <p>Siphon for freestanding washbasin - floor drain Sifon para lavabo freestanding - sortie au sol Siphon pour lavabo freestanding - salida a suelo Siphon für Säulewaschbecken Freestanding - Abgang senkrecht Сифон для отдельностоящей раковины - сливом в пол</p>		SHFRSI	0,30		58,00		
 <p>Fixing bracket between washbasin and Itaca column (mandatory). Soporte de fijación entre lavabo y columna Itaca (obligatorio). Support de fixation entre le lavabo et la colonne Itaca (obligatoire). Befestigungselement zwischen Waschbecken und Säule Itaca (obligatorisch). Крепежный кронштейн между раковиной и пьедесталом Itaca (обязательно).</p>	25 x 8 x h 10	ITFI	0,23		83,00		
 <p>Connector and joint (mandatory) Extensión y anillo (obligatorio) Rallonge et opercule (nécessaire) Ring und Drain-Erweiterung (geböten) Удлинитель и кольцо для тумбы (обязательный)</p>		PROTIB	0,25		62,00		











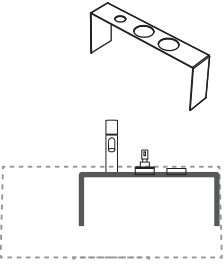





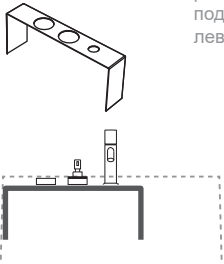







	Product code Artículo Article Artikel Артикул	Net weight (Kg) Peso neto Poids net Reingewicht вес нетто	Finishes Acabados Finitions Farbe Отделки	Euro Евро
 Universal click/clack drain in CHROME with ceramic lid Válvula universal click/clack Cromado con tapa en cerámica / Bonde universelle clic/clac Chromé avec clapet en céramique / Universal-Ablaufgarnitur Click-Clack Chrom mit Keramikstopfen / Универсальный донный клапан click/clack хром с керамической крышкой	PIL01(X)*	0,40	<ul style="list-style-type: none">  Gloss White  *X = N - Gloss Black  *X = FU - Fumo  *X = TP- Talpa  Le Terre di Cielo  Le Acque di Cielo 	<ul style="list-style-type: none"> 95,00 114,00 139,00 139,00 139,00 139,00
 Universal click/clack drain in BLACK MATT finish with ceramic lid Válvula universal click/clack Negro Matt con tapa en cerámica / Bonde universelle clic/clac Noir Mat avec clapet en céramique / Universal-Ablaufgarnitur Click-Clack Matt Schwarz mit Keramikstopfen / Универсальный донный клапан click/clack черный матовый с керамической крышкой	PIL01NM(X)*	0,40	<ul style="list-style-type: none">  Gloss White  *X = N - Gloss Black  *X = FU - Fumo  *X = TP- Talpa  Le Terre di Cielo  Le Acque di Cielo 	<ul style="list-style-type: none"> 120,00 159,00 169,00 169,00 169,00 169,00
 Universal click/clack drain in CEMENTO finish with ceramic lid Válvula universal click/clack Cemento con tapa en cerámica / Bonde universelle clic/clac Cemento avec clapet en céramique / Universal-Ablaufgarnitur Click-Clack Cement mit Keramikstopfen / Универсальный донный Cemento click/clack с керамической крышкой	PIL01CM(X)*	0,40	<ul style="list-style-type: none">  Gloss White  *X = N - Gloss Black  *X = FU - Fumo  *X = TP- Talpa  Le Terre di Cielo  Le Acque di Cielo 	<ul style="list-style-type: none"> 120,00 159,00 169,00 169,00 169,00 169,00
 Universal click/clack drain in BRONZE with ceramic lid Válvula universal click/clack Bronce con tapa en cerámica / Bonde / Universal-Ablaufgarnitur Click-Clack Bronze mit Keramikstopfen / Универсальный донный клапан click/clack бронза с керамической крышкой	PIL01BR(X)*	0,40	<ul style="list-style-type: none">  Gloss White  *X = N - Gloss Black  *X = FU - Fumo  *X = TP- Talpa  Le Terre di Cielo  Le Acque di Cielo 	<ul style="list-style-type: none"> 135,00 171,00 182,00 182,00 182,00 182,00
 CHROMED siphon Sifone Cromado \ Siphon Chromé \ Siphon Verchromt \ сифон Chrome	SISP	0,93	 Chrome	133,00
 MATT BLACK siphon Sifone Negro Mate \ Siphon Noir Mat \ Siphon Schwarz Matt \ Сифон Черный матовый	SIFN	0,93	 Matt Black	194,00
 CEMENTO siphon Sifone Cemento \ Siphon Cemento \ Siphon Cemento \ сифон Cemento	SIFCM	0,93	 Cemento	194,00
 BRONZE siphon Sifone Bronce \ Siphon Bronze \ Siphon Bronze \ бронза сифон	SIFBR	0,93	 Bronze	220,00

Technical symbols legend / Símbolos técnicos clave / Légende symboles techniques / Technische Zeichenerklärung / Перечень технических символов





 all sides are enamelled con todos los lados esmaltados / avec tous les côtés émaillés / alle Seiten glasiert / все стороны глазурованные	 no tap holes sin agujero para grifo / sans orifice robinet / ohne Hahnloch / все стороны покрыты эмалью	 with overflow con rebosadero / avec trop-plein / mit Überlauf / с переливом	 on top installation instalación de apoyo / installation à partir du plan / Montage auf Platte / установка на столешницу
---	---	---	---

with fixing parts
fijaciones incluidas
fixations incluses
inklusive Befestigungen
в комплекте с крепежами

Le Terre di Cielo	 TL - Talco	 PM - Pomice	 BR - Brina	 BA - Basalto	 LV - Lavagna	 CM - Cemento	 FN - Fango	 CA - Cacao
	 AN - Arenaria	 AV - Avena	 LN - Lino	 AG - Agave	 MU - Muschio	 PL - Polvere	 CP - Cipria	 CN - Canapa
Le Acque di Cielo	 OL - Oltremare	 SM - Smeraldo	 AL - Alga	 CO - Corallo	 NI - Ninfea	 AM - Anemone		

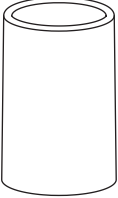
	Size (cm) Medidas Dimensions Maße Размеры	Product code Artículo Article Artikel Артикул	Net weight (Kg) Peso neto Poids net Reingewicht вес нетто	Finishes Acabados Finitions Farbe Отделки	Euro Евро
 <p>Fitting in stainless steel for Itaca oval washbasin, with tap hole, housing for dispenser and tumbler, right version. Accesorio en acero inoxidable para lavabo Itaca ovalado, con orificio grifería, espacio para dispensador y vaso, versión derecha. Accessoire en acier inoxydable pour lavabo Itaca ovale, avec trou de robinetterie, logement pour distributeur et gobelet, version droite. Zubehör aus edelstahl für Waschbecken Itaca oval, mit Hahnloch, Aufnahme für Spender und Glas, Ausführung rechts. Аксессуары из нержавеющей для овальной раковины Itaca, с отверстием под смеситель, подставка под диспенсер и стаканчик, левосторонний.</p>	42 x 8 x h16	ITMLDX(X)* ITMLDXSF(X)* no tap hole sin agujero sans orifice ohne Loch без отверстия		<ul style="list-style-type: none">  Le Acque di Cielo 323,00  *X = FU - Fumo 323,00  *X = TP - Talpa 323,00  *X = NM - Matt Black 297,00  *X = CM - Cemento 310,00 	
 <p>Fitting in stainless steel for Itaca oval washbasin, with tap hole, housing for dispenser and tumbler, left version. Accesorio en acero inoxidable para lavabo Itaca ovalado, con orificio grifería, espacio para dispensador y vaso, versión izquierda. Accessoire en acier inoxydable pour lavabo Itaca ovale, avec trou de robinetterie, logement pour distributeur et gobelet, version gauche. Zubehör aus edelstahl für Waschbecken Itaca oval, mit Hahnloch, Aufnahme für Spender und Glas, Ausführung links. Аксессуары из нержавеющей для овальной раковины Itaca, с отверстием под смеситель, подставка под диспенсер и стаканчик, правосторонний.</p>	42 x 8 x h16	ITMLSX(X)* ITMLSXSF(X)* no tap hole sin agujero sans orifice ohne Loch без отверстия		<ul style="list-style-type: none">  Le Acque di Cielo 323,00  *X = FU - Fumo 323,00  *X = TP - Talpa 323,00  *X = NM - Matt Black 297,00  *X = CM - Cemento 310,00 	
 <p>Metal dispenser Dispensador de metal \ Distributeur en métal \ Spender aus Metall \ Диспенсер из металла</p>	Ø6 x 18 h	ACDIM(X)*	0,50	<ul style="list-style-type: none">  Le Acque di Cielo 229,00  *X = FU - Fumo 229,00  *X = TP - Talpa 229,00  *X = NM - Matt Black 204,00  *X = CM - Cemento 204,00 	
 <p>Metal cup Vaso en metal \ Verre en métal \ Glas aus Metall \ Стаканчик из металла</p>	Ø6 x 11 h	ACBIM(X)*	0,20	<ul style="list-style-type: none">  Le Acque di Cielo 86,00  *X = FU - Fumo 86,00  *X = TP - Talpa 86,00  *X = NM - Matt Black 78,00  *X = CM - Cemento 78,00 	

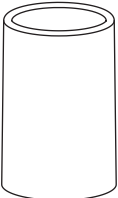

	Size (cm) Medidas Dimensions Maße Размеры	Product code Artículo Article Artikel Артикул	Net weight (Kg) Peso neto Poids net Reingewicht вес нетто	Finishes Acabados Finitions Farbe Отделки	Euro Евро	Pz. шт. pallet Italia	Pz. шт. pallet Cont.
  <p>Freestanding washbasin wall drain Lavabo freestanding con salida a pared Lavabo sur pied avec sortie au mur Freistehender Säulenwaschtisch mit Abgang waagrecht Раковина отдельностоящая, пьедестал со сливом в стену</p>	ø 53 x h 85	ITFREEP(X)*	65,00	<ul style="list-style-type: none"> Gloss White *X = Gloss Black *X = FU - Fumo *X = TP - Talpa Le Terre di Cielo Le Acque di Cielo 	3630,00 5060,00 5060,00 5060,00 5060,00 5060,00		
  <p>Freestanding washbasin floor drain Lavabo freestanding con salida a suelo Lavabo sur pied avec sortie au sol Freistehender Säulenwaschtisch mit Abgang senkrecht Раковина отдельностоящая, пристенная установка</p>	ø 53 x h 85	ITFREEC(X)*	65,00	<ul style="list-style-type: none"> Gloss White *X = Gloss Black *X = FU - Fumo *X = TP - Talpa Le Terre di Cielo Le Acque di Cielo 	3630,00 5060,00 5060,00 5060,00 5060,00 5060,00		
 <p>Siphon for freestanding washbasin - floor drain Sifon para lavabo freestanding - sortie au sol Siphon pour lavabo freestanding - salida a suelo Siphon für Säulewaschbecken Freestanding - Abgang senkrecht Сифон для отдельностоящей раковины - пьедестал со сливом в пол</p>		SHFRSI	0,30		58,00		

Technical symbols legend

Simbolos técnicos clave / Légende symboles techniques / Technische Zeichenerklärung / Перечень технических символов

 **all sides are enamelled**
con todos los lados esmaltados
avec tous les côtés émaillés
alle Seiten glasiert
все стороны покрыты эмалью

 **no tap holes**
sin agujero para grifo
sans orifice robinet
ohne Hahnloch
без отверстия под смеситель















 **with overflow**
con rebosadero
avec trop-plein
mit Überlauf
с переливом

























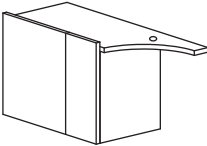

 **freestanding installation, wall trap**
instalación freestanding a pared
installation autoportante murale
freistehende Montage an der Wand
свободностоящая пристенная установка

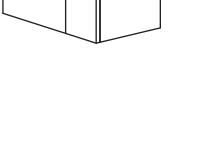

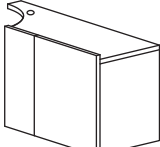



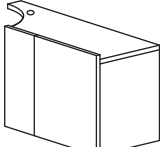







 **room centre freestanding installation**
instalación freestanding centro habitación
installation autoportante centre pièce
freistehende Montage in der Raummitte
свободностоящая установка по центру комнаты

 **with fixing parts**
fijaciones incluidas
fixations incluses
inklusive Befestigungen
в комплекте с крепежами

Le Terre di Cielo TL - Talco PM - Pomice BR - Brina BA - Basalto LV - Lavagna CM - Cemento FN - Fango CA - Cacao
 AN - Arenaria AV - Avena LN - Lino AG - Agave MU - Muschio PL - Polvere CP - Cipria CN - Canapa
Le Acque di Cielo OL - Oltremare SM - Smeraldo AL - Alga CO - Corallo NI - Ninfea AM - Anemone

	Product code Artículo Article Artikel Артикул	Net weight (Kg) Peso neto Poids net Reingewicht вес нетто	Finishes Acabados Finitions Farbe Отделки	Euro Евро
 <p>Drain in BLACK MATT finish with ceramic lid, for Itaca freestanding washbasin Válvula Negro Matt con tapa en cerámica Bonde Noir Mat avec clapet en céramique Ablaufgarnitur Matt Schwarz mit Keramikstopfen донный клапан черный матовый с керамической крышкой</p>	ITPILFREEM(X)*		<ul style="list-style-type: none">  Gloss White 165,00  *X = N - Gloss Black 176,00  *X = FU - Fumo 176,00  *X = TP - Talpa 176,00  Le Terre di Cielo 176,00  Le Acque di Cielo 176,00 	
 <p>CHROMED siphon Sifone Cromado \ Siphon Chromé \ Siphon Verchromt \ сифон Chrome</p>	SISP	0,93	 Chrome	133,00
 <p>MATT BLACK siphon Sifone Negro Mate \ Siphon Noir Mat \ Siphon Schwarz Matt \ Сифон Черный МАТОВЫЙ</p>	SIFN	0,93	 Matt Black	194,00
 <p>CEMENTO siphon Sifone Cemento \ Siphon Cemento \ Siphon Cemento \ сифон Cemento</p>	SIFCM	0,93	 Cemento	194,00
 <p>BRONZE siphon Sifone Bronce \ Siphon Bronze \ Siphon Bronze \ бронза сифон</p>	SIFBR	0,93	 Bronze	220,00

	Size (cm) Medidas Dimensions Maße Размеры	Product code Artículo Article Artikel Артикул	Net weight (Kg) Peso neto Poids net Reingewicht вес нетто	Finishes Acabados Finitions Farbe Отделки	Euro	Pz. шт. pallet Italia	Pz. шт. pallet Cont.
 <p>Freestanding washbasin wall drain Lavabo freestanding con salida a pared Lavabo sur pied avec sortie au mur Freistehender Säulenwaschtisch mit Abgang waagrecht Раковина отдельностоящая, пьедестал со сливом в стену</p>	∅ 53 x h 85	ITFREEP(X)*	65,00	<ul style="list-style-type: none">  Gloss White  *X = N - Gloss Black  *X = FU - Fumo  *X = TP - Talpa  Le Terre di Cielo  Le Acque di Cielo 	3630,00 5060,00 5060,00 5060,00 5060,00 5060,00		
 <p>Freestanding washbasin floor drain Lavabo freestanding con salida a suelo Lavabo sur pied avec sortie au sol Freistehender Säulenwaschtisch mit Abgang senkrecht Раковина отдельностоящая, пристенная установка</p>	∅ 53 x h 85	ITFREEC(X)*	65,00	<ul style="list-style-type: none">  Gloss White  *X = N - Gloss Black  *X = FU - Fumo  *X = TP - Talpa  Le Terre di Cielo  Le Acque di Cielo 	3630,00 5060,00 5060,00 5060,00 5060,00 5060,00		
 <p>Siphon for freestanding washbasin - floor drain Sifon para lavabo freestanding - sortie au sol Sifon pour lavabo freestanding - salida a suelo Siphon für Säulewaschbecken Freestanding - Abgang senkrecht Сифон для отдельностоящей раковины - сливом в пол</p>		SHFRSI	0,30		58,00		
 <p>Itaca suspended cabinet 90 left lacquered Mueble lacado suspendido 90 - izquierda \ Meuble suspendu 90 laqué - gauche \ lackierter Möbel 90 - links \ Тумбы подвесная 90 крашенные -слева</p>	88 x 31 x h 43	ITMS90SXL(X)* ITMS90SXLSF(X)* no tap hole sin agujero sans orifice ohne Loch без отверстия		<ul style="list-style-type: none">  *X = FU - Fumo  *X = TP - Talpa  Le Terre di Cielo*  Le Acque di Cielo 	1485,00 1485,00 1320,00 1485,00		
 <p>Itaca suspended cabinet 90 left in wooden finish Mueble de madera suspendido 90 - izquierda \ Meuble suspendu 90 en bois - gauche \ Holzmöbel 90 - links \ Тумбы с отделкой натуральным шпоном 90 -слева</p>		ITMS90SXE(X)* ITMS90SXESF(X)* no tap hole sin agujero sans orifice ohne Loch без отверстия		<ul style="list-style-type: none">  EsSENze Rovere •  *X = EU - Eucalipto 	1857,00 2104,00		
 <p>Itaca suspended cabinet 90 right lacquered Mueble lacado suspendido 90 - derecha \ Meuble suspendu 90 laqué - droite \ lackierter Möbel 90 - rechts \ Тумбы 90 крашенные - справа</p>	88 x 31 x h 43	ITMS90DXL(X)* ITMS90DXLSF(X)* no tap hole sin agujero sans orifice ohne Loch без отверстия		<ul style="list-style-type: none">  *X = FU - Fumo  *X = TP - Talpa  Le Terre di Cielo*  Le Acque di Cielo 	1485,00 1485,00 1320,00 1485,00		
 <p>Itaca suspended cabinet 90 right in wooden finish Mueble de madera suspendido 90 - derecha \ Meuble suspendu 90 en bois - droite \ Holzmöbel 90 - rechts \ Тумбы с отделкой натуральным шпоном 90 - справа</p>		ITMS90DXE(X)* ITMS90DXESF(X)* no tap hole sin agujero sans orifice ohne Loch без отверстия		<ul style="list-style-type: none">  EsSENze Rovere •  *X = EU - Eucalipto 	1857,00 2104,00		















	Product code Artículo Article Artikel Артикул	Net weight (Kg) Peso neto Poids net Reingewicht вес нетто	Finishes Acabados Finitions Farbe Отделки	Euro Евро
 <p>Drain in BLACK MATT finish with ceramic lid, for Itaca freestanding washbasin Válvula Negro Matt con tapa en cerámica Bonde Noir Mat avec clapet en céramique Ablaufgarnitur Matt Schwarz mit Keramikstopfen донный клапан черный матовый с керамической крышкой</p>	ITPILFREEM(X)*		<ul style="list-style-type: none">  Gloss White 165,00  *X = N - Gloss Black 176,00  *X = FU - Fumo 176,00  *X = TP - Talpa 176,00  Le Terre di Cielo 176,00  Le Acque di Cielo 176,00 	
 <p>CHROMED siphon Sifone Cromado \ Siphon Chromé \ Siphon Verchromt \ сифон Chrome</p>	SISP	0,93	 Chrome	133,00
 <p>MATT BLACK siphon Sifone Negro Mate \ Siphon Noir Mat \ Siphon Schwarz Matt \ Сифон Черный матовый</p>	SIFN	0,93	 Matt Black	194,00
 <p>CEMENTO siphon Sifone Cemento \ Siphon Cemento \ Siphon Cemento \ сифон Cemento</p>	SIFCM	0,93	 Cemento	194,00
 <p>BRONZE siphon Sifone Bronce \ Siphon Bronze \ Siphon Bronze \ бронза сифон</p>	SIFBR	0,93	 Bronze	220,00



Technical symbols legend / Símbolos técnicos clave / Légende symboles techniques / Technische Zeichenerklärung / Перечень технических символов







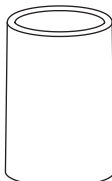
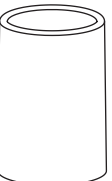

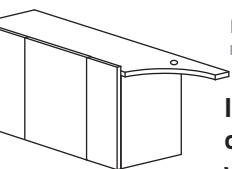
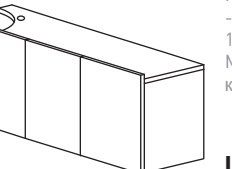
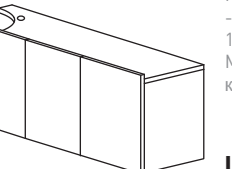
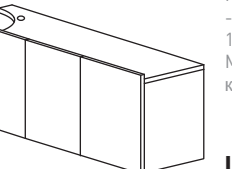





-  **all sides are enamelled**
 con todos los lados esmaltados
 avec tous les côtés émaillés
 alle Seiten glasiert
 все стороны покрыты эмалью
-  **no tap holes**
 sin agujero para grifo
 sans orifice robinet
 ohne Hahnloch
 без отверстия под смеситель
-  **with overflow**
 con rebosadero
 avec trop-plein
 mit Überlauf
 с переливом
-  **back to wall freestanding installation**
 instalación freestanding a pared
 installation autoportante murale
 freistehende Montage an der Wand
 свободная установка пристенная
-  **room centre freestanding installation**
 instalación freestanding centro habitación
 installation autoportante centre pièce
 freistehende Montage in der Raummitte
 свободная установка по центру комнаты
-  **with fixing parts**
 fijaciones incluidas
 fixations incluses
 inklusive Befestigungen
 в комплекте с крепежами

- Le Terre di Cielo
-  TL - Talco
 -  PM - Pomice
 -  BR - Brina
 -  BA - Basalto
 -  LV - Lavagna
 -  CM - Cemento
 -  FN - Fango
 -  CA - Cacao
 -  AN - Arenaria
 -  AV - Avena
 -  LN - Lino
 -  AG - Agave
 -  MU - Muschio
 -  PL - Polvere
 -  CP - Cipria
 -  CN - Canapa
- Le Acque di Cielo
-  OL - Oltremare
 -  SM - Smeraldo
 -  AL - Alga
 -  CO - Corallo
 -  NI - Ninfea
 -  AM - Anemone

- **Essenze Rovere**
-  RS - Rovere Sbiancato
-  RN - Rovere Naturale
-  RN - Rovere Nero
-  RT - Rovere Tinto Noce

- * **Terre/Acque di Cielo laquering available for cabinet**
*lacados Terre/Acque di Cielo disponibles para mueble /
 laquages Terre/Acque di Cielo disponibles pour le meuble /
 Für Möbel erhältliche Lackierungen Terre/Acque di Cielo /
 крашенная отделка Terre/Acque di Cielo доступна для
 ящика и столешницы*
-  TL - Talco
 -  PM - Pomice
 -  BR - Brina
 -  AN - Arenaria
 -  AV - Avena
 -  CM - Cemento
 -  BA - Basalto
 -  MU - Muschio
 -  AG - Agave
 -  OL - Oltremare
 -  SM - Smeraldo
 -  AL - Alga
 -  CO - Corallo
 -  NI - Ninfea
 -  AM - Anemone

	Size (cm) Medidas Dimensions Maße Размеры	Product code Artículo Article Artikel Артикул	Net weight (kg) Peso neto Poids net Reingewicht вес нетто	Finishes Acabados Finitions Farbe Отделки	Euro Евро	Pz. шт. pallet Italia	Pz. шт. pallet Cont.
 <p>Freestanding washbasin wall drain Lavabo freestanding con salida a pared Lavabo sur pied avec sortie au mur Freistehender Säulenwaschtisch mit Abgang waagrecht Раковина отдельностоящая, пьедестал со сливом в стену</p>	ø 53 x h 85	ITFREEP(X)*	65,00	<ul style="list-style-type: none"> ● Gloss White ● *X = N - Gloss Black ● *X = FU - Fumo ● *X = TP - Talpa ● Le Terre di Cielo ● Le Acque di Cielo 	<p>3630,00</p> <p>5060,00</p> <p>5060,00</p> <p>5060,00</p> <p>5060,00</p> <p>5060,00</p>		
 <p>Freestanding washbasin floor drain Lavabo freestanding con salida a suelo Lavabo sur pied avec sortie au sol Freistehender Säulenwaschtisch mit Abgang senkrecht Раковина отдельностоящая, пристенная установка</p>	ø 53 x h 85	ITFREEC(X)*	65,00	<ul style="list-style-type: none"> ● Gloss White ● *X = N - Gloss Black ● *X = FU - Fumo ● *X = TP - Talpa ● Le Terre di Cielo ● Le Acque di Cielo 	<p>3630,00</p> <p>5060,00</p> <p>5060,00</p> <p>5060,00</p> <p>5060,00</p> <p>5060,00</p>		
 <p>Siphon for freestanding washbasin - floor drain Sifon para lavabo freestanding - sortie au sol Siphon pour lavabo freestanding - salida a suelo Siphon für Säulewaschbecken Freestanding - Abgang senkrecht Сифон для отдельностоящей раковины - сливом в пол</p>		SHFRSI	0,30		58,00		
 <p>Itaca suspended cabinet 128 left lacquered Mueble lacado suspendido 128 - izquierda \ Meuble suspendu 128 laqué - gauche \ lackierter Möbel 128 - links \ Тумбы 128 крашенные -слева</p>	125 x 31 x h 43	ITMS128SXL(X)* ITMS128SXLSE(X)* no tap hole sin agujero sans orifice ohne Loch без отверстия		<ul style="list-style-type: none"> ● *X = FU - Fumo ● *X = TP - Talpa ● Le Terre di Cielo* ● Le Acque di Cielo 	<p>1931,00</p> <p>1931,00</p> <p>1758,00</p> <p>1931,00</p>		
 <p>Itaca suspended cabinet 128 left in wooden finish Mueble de madera suspendido 128 - izquierda \ Meuble suspendu 128 en bois - gauche \ Holzmöbel 128 - links \ Тумбы с отделкой натуральным шпоном 128 - слева</p>	125 x 31 x h 43	ITMS128SXE(X)* ITMS128SXESE(X)* no tap hole sin agujero sans orifice ohne Loch без отверстия		<ul style="list-style-type: none"> ● Essenze Rovere • ● Eucalipto 	<p>2475,00</p> <p>2921,00</p>		
 <p>Itaca suspended cabinet 128 right lacquered Mueble lacado suspendido 128 - derecha \ Meuble suspendu 128 laqué - droite \ lackierter Möbel 128 - Rechts \ Тумбы 128 крашенные - справа</p>	125 x 31 x h 43	ITMS128DXL(X)* ITMS128DXLSE(X)* no tap hole sin agujero sans orifice ohne Loch без отверстия		<ul style="list-style-type: none"> ● *X = FU - Fumo ● *X = TP - Talpa ● Le Terre di Cielo* ● Le Acque di Cielo 	<p>1931,00</p> <p>1931,00</p> <p>1758,00</p> <p>1931,00</p>		
 <p>Itaca suspended cabinet 128 right in wooden finish Mueble de madera suspendido 128 - derecha \ Meuble suspendu 128 en bois - droite \ Holzmöbel 128 - rechts \ Тумбы с отделкой натуральным шпоном 128 - справа</p>	125 x 31 x h 43	ITMS128DXE(X)* ITMS128DXESE(X)* no tap hole sin agujero sans orifice ohne Loch без отверстия		<ul style="list-style-type: none"> ● Essenze Rovere • ● Eucalipto 	<p>2475,00</p> <p>2921,00</p>		















	Product code Artículo Article Artikel Артикул	Net weight (Kg) Peso neto Poids net Reingewicht вес нетто	Finishes Acabados Finitions Farbe Отделки	Euro Евро
 <p>Drain in BLACK MATT finish with ceramic lid, for Itaca freestanding washbasin Válvula Negro Matt con tapa en cerámica Bonde Noir Mat avec clapet en céramique Ablaufgarnitur Matt Schwarz mit Keramikstopfen донный клапан черный матовый с керамической крышкой</p>	ITPILFREENM(X)*		<ul style="list-style-type: none">  Gloss White 165,00  *X = N - Gloss Black 176,00  *X = FU - Fumo 176,00  *X = TP - Talpa 176,00  Le Terre di Cielo 176,00  Le Acque di Cielo 176,00 	
 <p>CHROMED siphon Sifone Cromado \ Siphon Chromé \ Siphon Verchromt \ сифон Chrome</p>	SISP	0,93	 Chrome	133,00
 <p>MATT BLACK siphon Sifone Negro Mate \ Siphon Noir Mat \ Siphon Schwarz Matt \ Сифон Черный матовый</p>	SIFN	0,93	 Matt Black	194,00
 <p>CEMENTO siphon Sifone Cemento \ Siphon Cemento \ Siphon Cemento \ сифон Cemento</p>	SIFCM	0,93	 Cemento	194,00
 <p>BRONZE siphon Sifone Bronce \ Siphon Bronze \ Siphon Bronze \ бронза сифон</p>	SIFBR	0,93	 Bronze	220,00

























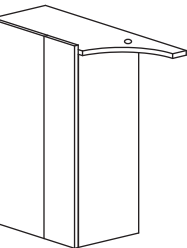



Technical symbols legend / Símbolos técnicos clave / Légende symboles techniques / Technische Zeichenerklärung / Перечень технических символов



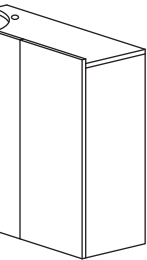



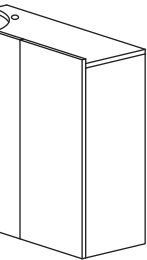







-  **all sides are enamelled**
con todos los lados esmaltados
avec tous les côtés émaillés
alle Seiten glasiert
все стороны покрыты эмалью
-  **no tap holes**
sin agujero para grifo
sans orifice robinet
ohne Hahnloch
без отверстия под смеситель
-  **with overflow**
con rebosadero
avec trop-plein
mit Überlauf
с переливом
-  **back to wall freestanding installation**
instalación freestanding a pared
installation autoportante murale
freistehende Montage an der Wand
свободстоящая пристенная установка
-  **room centre freestanding installation**
instalación freestanding centro habitación
installation autoportante centre pièce
freistehende Montage in der Raummittle
свободстоящая установка по центру комнаты
-  **with fixing parts**
fijaciones incluidas
fixations incluses
inklusive Befestigungen
в комплекте с крепежами

- Le Terre di Cielo
-  TL - Talco
 -  PM - Pomice
 -  BR - Brina
 -  BA - Basalto
 -  LV - Lavagna
 -  CM - Cemento
 -  FN - Fango
 -  CA - Cacao
 -  AN - Arenaria
 -  AV - Avena
 -  LN - Lino
 -  AG - Agave
 -  MU - Muschio
 -  PL - Polvere
 -  CP - Cipria
 -  CN - Canapa
- Le Acque di Cielo
-  OL - Oltremare
 -  SM - Smeraldo
 -  AL - Alga
 -  CO - Corallo
 -  NI - Ninfea
 -  AM - Anemone

-  **Essenze Rovere**
-  RS - Rovere Sbiancato
-  RN - Rovere Naturale
-  RN - Rovere Nero
-  RT - Rovere Tinto Noce

- * Terre/Acque di Cielo laquering available for cabinet
 / lacados Terre/Acque di Cielo disponibles para mueble /
 laquages Terre/Acque di Cielo disponibles pour le meuble /
 Für Möbel erhältliche Lackierungen Terre/Acque di Cielo /
 крашенная отделка Terre/Acque di Cielo доступна для
 ящика и столешницы
-  TL - Talco
 -  PM - Pomice
 -  BR - Brina
 -  AN - Arenaria
 -  AV - Avena
 -  CM - Cemento
 -  BA - Basalto
 -  MU - Muschio
 -  AG - Agave
 -  OL - Oltremare
 -  SM - Smeraldo
 -  AL - Alga
 -  CO - Corallo
 -  NI - Ninfea
 -  AM - Anemone

	Size (cm) Medidas Dimensions Maße Размеры	Product code Artículo Article Artikel Артикул	Net weight (kg) Peso neto Poids net Reingewicht вес нетто	Finishes Acabados Finitions Farbe Отделки	Euro Евро	Pz. шт. pallet Italia	Pz. шт. pallet Cont.
 <p>Freestanding washbasin wall drain Lavabo freestanding con salida a pared Lavabo sur pied avec sortie au mur Freistehender Säulenwaschtisch mit Abgang waagrecht Раковина отдельностоящая, пьедестал со сливом в стену</p>	∅ 53 x h 85	ITFREEP(X)*	65,00	<ul style="list-style-type: none">  Gloss White  *X = N - Gloss Black  *X = FU - Fumo  *X = TP - Talpa  Le Terre di Cielo  Le Acque di Cielo 	3630,00		
 <p>Freestanding washbasin floor drain Lavabo freestanding con salida a suelo Lavabo sur pied avec sortie au sol Freistehender Säulenwaschtisch mit Abgang senkrecht Раковина отдельностоящая, пристенная установка</p>	∅ 53 x h 85	ITFREEC(X)*	65,00	<ul style="list-style-type: none">  Gloss White  *X = N - Gloss Black  *X = FU - Fumo  *X = TP - Talpa  Le Terre di Cielo  Le Acque di Cielo 	3630,00		
 <p>Siphon for freestanding washbasin - floor drain Sifon para lavabo freestanding - sortie au sol Siphon pour lavabo freestanding - salida a suelo Siphon für Säulewaschbecken Freestanding - Abgang senkrecht Сифон для отдельностоящей раковины - сливом в пол</p>		SHFRSI	0,30		58,00		
 <p>Itaca floor standing cabinet 90 left lacquered Mueble lacado a suelo 90 - izquierda \ Meuble au sol 90 laqué - gauche \ lackierter Standmöbel 90 - links \ напольная мебель крашенные 90 - слева</p>	88 x 31 x h 85	ITMT90SXL(X)* ITMT90SXLSEF(X)* no tap hole sin agujero sans orifice ohne Loch без отверстия		<ul style="list-style-type: none">  *X = FU - Fumo  *X = TP - Talpa  Le Terre di Cielo*  Le Acque di Cielo 	1430,00		
 <p>Itaca floor standing cabinet 90 left in wooden finish Mueble de madera a suelo 90 - izquierda \ Meuble au sol 90 en bois - gauche \ Holzbodenschrank 90 - links \ Тумбы с отделкой натуральным шпоном напольная 90 - слева</p>		ITMT90SXE(X)* ITMT90SXESF(X)* no tap hole sin agujero sans orifice ohne Loch без отверстия		<ul style="list-style-type: none">  Essenze Rovere •  Eucalipto 	1708,00		
 <p>Itaca floor standing cabinet 90 right lacquered Mueble lacado a suelo 90 - derecha \ Meuble au sol 90 laqué - droite \ lackierter Standmöbel 90 - rechts \ напольная мебель крашенные 90 - справа</p>	88 x 31 x h 85	ITMT90DXL(X)* ITMT90DXLSEF(X)* no tap hole sin agujero sans orifice ohne Loch без отверстия		<ul style="list-style-type: none">  *X = FU - Fumo  *X = TP - Talpa  Le Terre di Cielo*  Le Acque di Cielo 	1430,00		
 <p>Itaca floor standing cabinet 90 right in wooden finish Mueble de madera a suelo 90 - derecha \ Meuble au sol 90 en bois - droite \ Holzbodenschrank 90 - rechts \ Тумбы с отделкой натуральным шпоном напольная 90 - справа</p>		ITMT90DXE(X)* ITMT90DXESF(X)* no tap hole sin agujero sans orifice ohne Loch без отверстия		<ul style="list-style-type: none">  Essenze Rovere •  Eucalipto 	1708,00		

	Product code Artículo Article Artikel Артикул	Net weight (kg) Peso neto Poids net Reingewicht вес нетто	Finishes Acabados Finitions Farbe Отделки	Euro Евро
 <p>Drain in BLACK MATT finish with ceramic lid, for Itaca freestanding washbasin Válvula Negro Matt con tapa en cerámica Bonde Noir Mat avec clapet en céramique Ablaufgarnitur Matt Schwarz mit Keramikstopfen донный клапан черный матовый с керамической крышкой</p>	ITPILFREEN(X)*		<ul style="list-style-type: none">  Gloss White 165,00  *X = N - Gloss Black 176,00  *X = FU - Fumo 176,00  *X = TP - Talpa 176,00  Le Terre di Cielo 176,00  Le Acque di Cielo 176,00 	
 <p>CHROMED siphon Sifone Cromado \ Siphon Chromé \ Siphon Verchromt \ сифон Chrome</p>	SISP	0,93	 Chrome	133,00
 <p>MATT BLACK siphon Sifone Negro Mate \ Siphon Noir Mat \ Siphon Schwarz Matt \ Сифон Черный матовый</p>	SIFN	0,93	 Matt Black	194,00
 <p>CEMENTO siphon Sifone Cemento \ Siphon Cemento \ Siphon Cemento \ сифон Cemento</p>	SIFCM	0,93	 Cemento	194,00
 <p>BRONZE siphon Sifone Bronce \ Siphon Bronze \ Siphon Bronze \ бронза сифон</p>	SIFBR	0,93	 Bronze	220,00

























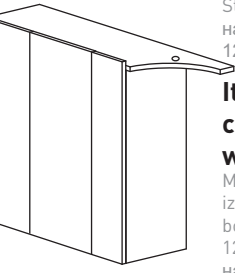



Technical symbols legend / Símbolos técnicos clave / Légende symboles techniques / Technische Zeichenerklärung / Перечень технических символов



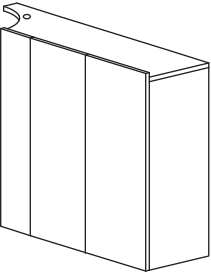



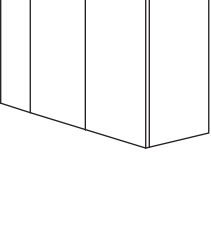







-  **all sides are enamelled**
con todos los lados esmaltados
avec tous les côtés émaillés
alle Seiten glasiert
все стороны покрыты эмалью
 -  **no tap holes**
sin agujero para grifo
sans orifice robinet
ohne Hahnloch
без отверстия под смеситель
 -  **with overflow**
con rebosadero
avec trop-plein
mit Überlauf
с переливом
 -  **back to wall freestanding installation**
instalación freestanding a pared
installation autoportante murale
freistehende Montage an der Wand
свободстоящая пристенная установка
 -  **room centre freestanding installation**
instalación freestanding centro habitación
installation autoportante centre pièce
freistehende Montage in der Raummitte
свободстоящая установка по центру комнаты
- with fixing parts**
fijaciones incluidas
fixations incluses
inklusive Befestigungen
в комплекте с крепежами

- Le Terre di Cielo**
-  TL - Talco
 -  PM - Pomice
 -  BR - Brina
 -  BA - Basalto
 -  LV - Lavagna
 -  CM - Cemento
 -  FN - Fango
 -  CA - Cacao
 -  AN - Arenaria
 -  AV - Avena
 -  LN - Lino
 -  AG - Agave
 -  MU - Muschio
 -  PL - Polvere
 -  CP - Cipria
 -  CN - Canapa
- Le Acque di Cielo**
-  OL - Oltremare
 -  SM - Smeraldo
 -  AL - Alga
 -  CO - Corallo
 -  NI - Ninfea
 -  AM - Anemone

- **Essenze Rovere**
-  RS - Rovere Sbiancato
 -  RN - Rovere Naturale
 -  RN - Rovere Nero
 -  RT - Rovere Tinto Noce

- * **Terre/Acque di Cielo laquering available for cabinet**
 / lacados Terre/Acque di Cielo disponibles para mueble /
 laquages Terre/Acque di Cielo disponibles pour le meuble /
 Für Möbel erhältliche Lackierungen Terre/Acque di Cielo /
 крашеная отделка Terre/Acque di Cielo доступна для
 ящика и столешницы
-  TL - Talco
 -  PM - Pomice
 -  BR - Brina
 -  AN - Arenaria
 -  AV - Avena
 -  CM - Cemento
 -  BA - Basalto
 -  MU - Muschio
 -  AG - Agave
 -  OL - Oltremare
 -  SM - Smeraldo
 -  AL - Alga
 -  CO - Corallo
 -  NI - Ninfea
 -  AM - Anemone

	Size (cm)	Product code	Net weight (Kg)	Finishes	Euro	Pz.	Pz.
	Medidas Dimensions Maße Размеры	Artículo Article Artikel Артикул	Peso neto Poids net Reingewicht вес нетто	Acabados Finitions Farbe Отделки	Евро	шт. pallet Italia	шт. pallet Cont.
 <p>Freestanding washbasin wall drain Lavabo freestanding con salida a pared Lavabo sur pied avec sortie au mur Freistehender Säulenwaschtisch mit Abgang waagrecht Раковина отдельностоящая, пьедестал со сливом в стену</p>	ø 53 x h 85	ITFREEP(X)*	65,00	<ul style="list-style-type: none">  Gloss White  *X = N - Gloss Black  *X = FU - Fumo  *X = TP - Talpa  Le Terre di Cielo  Le Acque di Cielo 	3630,00		
 <p>Freestanding washbasin floor drain Lavabo freestanding con salida a suelo Lavabo sur pied avec sortie au sol Freistehender Säulenwaschtisch mit Abgang senkrecht Раковина отдельностоящая, пристенная установка</p>	ø 53 x h 85	ITFREEC(X)*	65,00	<ul style="list-style-type: none">  Gloss White  *X = N - Gloss Black  *X = FU - Fumo  *X = TP - Talpa  Le Terre di Cielo  Le Acque di Cielo 	3630,00		
 <p>Siphon for freestanding washbasin - floor drain Sifon para lavabo freestanding - sortie au sol Siphon pour lavabo freestanding - salida a suelo Siphon für Säulewaschbecken Freestanding - Abgang senkrecht Сифон для отдельностоящей раковины - сливом в пол</p>		SHFRSI	0,30		58,00		
 <p>Itaca floor standing cabinet 128 left lacquered Mueble lacado a suelo 128 - izquierda \ Meuble au sol 128 laqué - gauche \ lackierter Standmöbel 128 - links \ напольная мебель крашенные 128 - слева</p>	125 x 31 x h 85	ITMT128SXL(X)* ITMT128SXLSF(X)* no tap hole sin agujero sans orifice ohne Loch без отверстия		<ul style="list-style-type: none">  *X = FU - Fumo  *X = TP - Talpa  Le Terre di Cielo*  Le Acque di Cielo 	2005,00		
 <p>Itaca floor standing cabinet 128 left in wooden finish Mueble de madera a suelo 128 - izquierda \ Meuble au sol 128 en bois - gauche \ Holzbodenschrank 128 - links \ Тумбы с отделкой натуральным шпоном напольная 128 -слева</p>		ITMT128SXE(X)* ITMT128SXESF(X)* no tap hole sin agujero sans orifice ohne Loch без отверстия		<ul style="list-style-type: none">  EsSENze ROvere •  EucALIPTO 	2599,00		
 <p>Itaca floor standing cabinet 128 right lacquered Mueble lacado a suelo 128 - derecha \ Meuble au sol 128 laqué - droite \ lackierter Standmöbel 128 - rechts \ напольная мебель крашенные 128 - справа</p>	125 x 31 x h 85	ITMT128DXL(X)* ITMT128DXLSF(X)* no tap hole sin agujero sans orifice ohne Loch без отверстия		<ul style="list-style-type: none">  *X = FU - Fumo  *X = TP - Talpa  Le Terre di Cielo*  Le Acque di Cielo 	2005,00		
 <p>Itaca floor standing cabinet 128 right in wooden finish Mueble de madera a suelo 128 - derecha \ Meuble au sol 128 en bois - droite \ Holzbodenschrank 128 - rechts \ Тумбы с отделкой натуральным шпоном напольная 128 - справа</p>		ITMT128DXE(X)* ITMT128DXESF(X)* no tap hole sin agujero sans orifice ohne Loch без отверстия		<ul style="list-style-type: none">  EsSENze ROvere •  EucALIPTO 	2599,00		





	Product code Artículo Article Artikel Артикул	Net weight (Kg) Peso neto Poids net Reingewicht вес нетто	Finishes Acabados Finitions Farbe Отделки	Euro Евро
 <p>Drain in BLACK MATT finish with ceramic lid, for Itaca freestanding washbasin Válvula Negro Matt con tapa en cerámica Bonde Noir Mat avec clapet en céramique Ablaufgarnitur Matt Schwarz mit Keramikstopfen донный клапан черный матовый с керамической крышкой</p>	ITPILFREEN(X)*		<ul style="list-style-type: none">  Gloss White 165,00  *X = N - Gloss Black 176,00  *X = FU - Fumo 176,00  *X = TP - Talpa 176,00  Le Terre di Cielo 176,00  Le Acque di Cielo 176,00 	
 <p>CHROMED siphon Sifone Cromado \ Siphon Chromé \ Siphon Verchromt \ сифон Chrome</p>	SISP	0,93	 Chrome	133,00
 <p>MATT BLACK siphon Sifone Negro Mate \ Siphon Noir Mat \ Siphon Schwarz Matt \ Сифон Черный матовый</p>	SIFN	0,93	 Matt Black	194,00
 <p>CEMENTO siphon Sifone Cemento \ Siphon Cemento \ Siphon Cemento \ сифон Cemento</p>	SIFCM	0,93	 Cemento	194,00
 <p>BRONZE siphon Sifone Bronce \ Siphon Bronze \ Siphon Bronze \ бронза сифон</p>	SIFBR	0,93	 Bronze	220,00





















Technical symbols legend / Símbolos técnicos clave / Légende symboles techniques / Technische Zeichenerklärung / Перечень технических символов

-  **all sides are enamelled**
con todos los lados esmaltados / avec tous les côtés émaillés / alle Seiten glasiert / все стороны покрыты эмалью
-  **no tap holes**
sin agujero para grifo / sans orifice robinet / ohne Hahnloch / без отверстия под смеситель
-  **with overflow**
con rebosadero / avec trop-plein / mit Überlauf / с переливом
-  **back to wall freestanding installation**
instalación freestanding a pared / installation autoportante murale / freistehende Montage an der Wand / свободная пристенная установка
-  **room centre freestanding installation**
instalación freestanding centro habitación / installation autoportante centre pièce / freistehende Montage in der Raummitte / свободная установка по центру комнаты
-  **with fixing parts**
fijaciones incluidas / fixations incluses / inklusive Befestigungen / в комплекте с крепежами

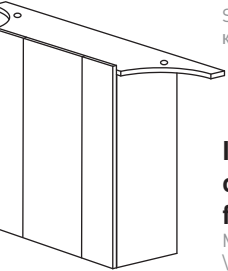





- Le Terre di Cielo
-  TL - Talco
 -  PM - Pomice
 -  BR - Brina
 -  BA - Basalto
 -  LV - Lavagna
 -  CM - Cemento
 -  FN - Fango
 -  CA - Cacao
 -  AN - Arenaria
 -  AV - Avena
 -  LN - Lino
 -  AG - Agave
 -  MU - Muschio
 -  PL - Polvere
 -  CP - Cipria
 -  CN - Canapa
- Le Acque di Cielo
-  OL - Oltremare
 -  SM - Smeraldo
 -  AL - Alga
 -  CO - Corallo
 -  NI - Ninfea
 -  AM - Anemone















- **Essenze Rovere**
-  RS - Rovere Sbiancato
 -  RN - Rovere Naturale
 -  RN - Rovere Nero
 -  RT - Rovere Tinto Noce

- * **Terre/Acque di Cielo laquering available for cabinet**
 / lacados Terre/Acque di Cielo disponibles para mueble /
 laquages Terre/Acque di Cielo disponibles pour le meuble /
 Für Möbel erhältliche Lackierungen Terre/Acque di Cielo /
 крашенная отделка Terre/Acque di Cielo доступна для
 ящика и столешницы
-  TL - Talco
 -  PM - Pomice
 -  BR - Brina
 -  AN - Arenaria
 -  AV - Avena
 -  CM - Cemento
 -  BA - Basalto
 -  MU - Muschio
 -  AG - Agave
 -  OL - Oltremare
 -  SM - Smeraldo
 -  AL - Alga
 -  CO - Corallo
 -  NI - Ninfea
 -  AM - Anemone

	Size (cm) Medidas Dimensions Maße Размеры	Product code Artículo Article Artikel Артикул	Net weight (Kg) Peso neto Poids net Reingewicht вес нетто	Finishes Acabados Finitions Farbe Отделки	Euro Евро	Pz. шт. pallet Italia	Pz. шт. pallet Cont.
 <p>Freestanding washbasin wall drain Lavabo freestanding con salida a pared Lavabo sur pied avec sortie au mur Freistehender Säulenwaschtisch mit Abgang waagrecht Раковина отдельностоящая, пьедестал со сливом в стену</p>	∅ 53 x h 85	ITFREEP(X)*	65,00	<ul style="list-style-type: none">  Gloss White  *X = N - Gloss Black  *X = FU - Fumo  *X = TP - Talpa  Le Terre di Cielo  Le Acque di Cielo 	3630,00 5060,00 5060,00 5060,00 5060,00 5060,00		
 <p>Freestanding washbasin floor drain Lavabo freestanding con salida a suelo Lavabo sur pied vec sortie au sol Freistehender Säulenwaschtisch mit Abgang senkrecht Раковина отдельностоящая, пристенная установка</p>	∅ 53 x h 85	ITFREEC(X)*	65,00	<ul style="list-style-type: none">  Gloss White  *X = N - Gloss Black  *X = FU - Fumo  *X = TP - Talpa  Le Terre di Cielo  Le Acque di Cielo 	3630,00 5060,00 5060,00 5060,00 5060,00 5060,00		
 <p>Siphon for freestanding washbasin - floor drain Sifon para lavabo freestanding - sortie au sol Siphon pour lavabo freestanding - salida a suelo Siphon für Säulewaschbecken Freestanding - Abgang senkrecht Сифон для отдельностоящей раковины - сливом в пол</p>		SHFRSI	0,30		58,00		
 <p>Itaca floor standing cabinet lacquered Mueble lacado a suelo \ Meuble au sol laqué \ lackierter Standmöbel \ напольная мебель крашенные</p>	135 x 31 x h 85	ITMTCL(X)* ITMTCLSF(X)* no tap hole sin agujero sans orifice ohne Loch без отверстия		<ul style="list-style-type: none">  FU - Fumo  TP - Talpa  Le Terre di Cielo*  Le Acque di Cielo 	1931,00 1931,00 1733,00 1931,00		
<p>Itaca floor standing cabinet in wooden finish Mueble de madera a suelo \ Meuble au sol en bois \ Holzbodenschrank \ Тумбы с отделкой натуральным шпоном напольная</p>		ITMTCE(X)* ITMTCESF(X)* no tap hole sin agujero sans orifice ohne Loch без отверстия	<ul style="list-style-type: none">  Essenze Rovere •  Eucalipto 	2500,00 2748,00			

Technical symbols legend | Símbolos técnicos clave | Légende symboles techniques | Technische Zeichenerklärung | Перечень технических символов

 all sides are enamelled con todos los lados esmaltados avec tous les côtés émaillés alle Seiten glasiert все стороны покрыты эмалью	 no tap holes sin agujero para grifo sans orifice robinet ohne Hähnlloch без отверстия под смеситель	 with overflow con rebosadero avec trop-plein mit Überlauf с переливом	 back to wall freestanding installation instalacion freestanding a pared installation autoportante murale freistehende Montage an der Wand свободностоящая пристенная установка	 room centre freestanding installation instalacion freestanding centro habitacion installation autoportante centre pièce freistehende Montage in der Raummitte свободностоящая установка по центру комнаты
 with fixing parts fijaciones incluidas fixations incluses inklusive Befestigungen в комплекте с крепежами				

	Product code Artículo Article Artikel Артикул	Net weight (Kg) Peso neto Poids net Reingewicht вес нетто	Finishes Acabados Finitions Farbe Отделки	Euro Евро
 <p>Drain in BLACK MATT finish with ceramic lid, for Itaca freestanding washbasin Válvula Negro Matt con tapa en cerámica Bonde Noir Mat avec clapet en céramique Ablaufgarnitur Matt Schwarz mit Keramikstopfen донный клапан черный матовый с керамической крышкой</p>	ITPILFREENM(X)*		<ul style="list-style-type: none">  Gloss White 165,00  *X = N - Gloss Black 176,00  *X = FU - Fumo 176,00  *X = TP - Talpa 176,00  Le Terre di Cielo 176,00  Le Acque di Cielo 176,00 	
 <p>CHROMED siphon Sifone Cromado \ Siphon Chromé \ Siphon Verchromt \ сифон Chrome</p>	SISP	0,93	 Chrome	133,00
 <p>MATT BLACK siphon Sifone Negro Mate \ Siphon Noir Mat \ Siphon Schwarz Matt \ Сифон Черный матовый</p>	SIFN	0,93	 Matt Black	194,00
 <p>CEMENTO siphon Sifone Cemento \ Siphon Cemento \ Siphon Cemento \ сифон Cemento</p>	SIFCM	0,93	 Cemento	194,00
 <p>BRONZE siphon Sifone Bronce \ Siphon Bronze \ Siphon Bronze \ бронза сифон</p>	SIFBR	0,93	 Bronze	220,00

- Le Terre di Cielo
-  TL - Talco
 -  PM - Pomice
 -  BR - Brina
 -  BA - Basalto
 -  LV - Lavagna
 -  CM - Cemento
 -  FN - Fango
 -  CA - Cacao
 -  AN - Arenaria
 -  AV - Avena
 -  LN - Lino
 -  AG - Agave
 -  MU - Muschio
 -  PL - Polvere
 -  CP - Cipria
 -  CN - Canapa
- Le Acque di Cielo
-  OL - Oltremare
 -  SM - Smeraldo
 -  AL - Alga
 -  CO - Corallo
 -  NI - Ninfea
 -  AM - Anemone

- **EsSENze ROvere**
-  RS - Rovere Sbiancato
 -  RN - Rovere Naturale
 -  RN - Rovere Nero
 -  RT - Rovere Tinto Noce

- * **Terre/Acque di Cielo laquering available for cabinet**
*/ lacados Terre/Acque di Cielo disponibles para mueble /
 laquages Terre/Acque di Cielo disponibles pour le meuble /
 Für Möbel erhältliche Lackierungen Terre/Acque di Cielo /
 крашеная отделка Terre/Acque di Cielo доступна для
 ящика и столешницы*
-  TL - Talco
 -  PM - Pomice
 -  BR - Brina
 -  AN - Arenaria
 -  AV - Avena
 -  CM - Cemento
 -  BA - Basalto
 -  MU - Muschio
 -  AG - Agave
 -  OL - Oltremare
 -  SM - Smeraldo
 -  AL - Alga
 -  CO - Corallo
 -  NI - Ninfea
 -  AM - Anemone

CIELO RIMLESS 2.0.1®



Wall-hung wc with fixing kit (4,5 LT) - rimless 2.0.1

Inodoro suspendido completo con fijaciones (4,5 LT) - sin brida - rimless 2.0.1 / Cuvette suspendue avec fixations (4,5 LT) - sans bride - rimless 2.0.1 / Wand-WC mit Befestigungskit (4,5 lt.) - ohne Spülrand - rimless 2.0.1 / Подвесной унитаз в комплекте с крепежами (4,5 литр) - без ободка - rimless 2.0.1

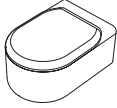

	Size (cm) Medidas Dimensions Maße Размеры	Product code Artículo Article Artikel Артикул	Net weight (Kg) Peso neto Poids net Reingewicht вес нетто	Finishes Acabados Finitions Farbe Отделки	Euro Евро	Pz. шт. pallet Italia	Pz. шт. pallet Cont.
<p>QUICK RELEASE HINGES</p> <p>Thermosetting seat & cover Asiento para inodoro Abattant thermodurcissable Wc-sitz thermotur Сиденье из термоотверждающейся смолы</p>	53 x 37 x h26	ITVSK(X)*	26,00	Gloss White *X = TL - Talco *X = N - Gloss Black *X = FU - Fumo *X = TP - Talpa Le Terre di Cielo * Le Acque di Cielo	473,00 616,00 693,00 693,00 693,00 693,00		
<p>QUICK RELEASE HINGES</p> <p>Thermosetting soft close seat & cover Asiento para inodoro amortiguado Abattant thermodurcissable soft Wc-sitz thermotur mit Abs. Сиденье из термоотверждающейся смолы с плавным опусканием</p>		CPVITTF(X)*		Gloss White *X = TL - Talco *X = N - Gloss Black *X = FU - Fumo *X = TP - Talpa Le Terre di Cielo * Le Acque di Cielo	188,00 296,00 316,00 316,00 316,00 316,00		
<p>Impact and acoustic protection panel Protección antigolpes y acústica Protection acoustique et anti-choc Stoss- und Schalldämmung Противоударная и акустическая защита</p>		PAA			17,00		
<p>Couple of fixing brackets for wall-hung wc/bidet Pareja de estribo para Inodoro/Bidet suspendido Étriers de fixation pour Wc/Bidet suspendus 1 Paar Halterungen für wandhängendes Wc/Bidet Монтажная рама для подвесного унитаза/биде</p>	3,3 x 18,5 x 55 h	508			39,00		

Technical symbols legend

Símbolos técnicos clave / Légende symboles techniques / Technische Zeichenerklärung / Перечень технических символов

<p>wall-hung installation / instalación suspendida / installation suspendue / wandhängende Montage / подвесная установка</p>	<p>with fixing parts / fijaciones incluidas / fixations incluses / inklusive Befestigungen / в комплекте с крепежами</p>	<p>4,5 l toilet tank / descarga 4,5 lt / évacuation à 4,5 l / 4,5 l-Spülung / бачок на 4,5 л</p>	<p>Combifix compatibility / compatible Combifix / mit Combifix kompatibel / совместим с combifix</p>	<p>quick release hinge / sistema Combifix / mit Combifix kompatibel / Takeoff Funktion / быстрый съем</p>
<p>with overflow / con rebosadero / avec trop-plein / mit Überlauf / с переливом</p>	<p>one tap hole / con 1 agujero monotrou / 1-Loch / одно отверстие под смеситель</p>	<p>wall-hung installation / instalación suspendida / installation suspendue / wandhängende Montage / подвесная установка</p>	<p>with fixing parts / fijaciones incluidas / fixations incluses / inklusive Befestigungen / в комплекте с крепежами</p>	

Acque di Cielo available for wc-bidet / Acque di Cielo disponibles para wc-bidet / Acque di Cielo disponibles pour cuvette-bidet / Für das WC/Bidet erhältliche Ausführungen Acque di Cielo / Отделка Acque di Cielo доступны для унитаза и биде











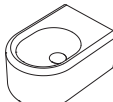



























* Terre di Cielo finishes available for wc-bidet / Acabados Terre di Cielo disponibles para wc-bidet / Finitions Terre di Cielo disponibles pour cuvette-bidet / Für das WC/Bidet erhältliche Ausführungen Terre di Cielo / Отделка Terre di Cielo доступны для унитаза и биде

OL - Oltremare	SM - Smeraldo	AL - Alga	CO - Corallo	NI - Ninfea	AM - Anemone
TL - Talco	PM - Pomice	BR - Brina	AN - Arenaria	AV - Avena	CM - Cemento
LN - Lino	BA - Basalto	LV - Lavagna			

Itaca - bidet

Can be ordered from January 2025
 On peut le commander à partir de Janvier 2025
 Disponible para pedir a partir de Enero del 2025
 lieferbar ab Januar 2025
 доступно к заказу с январь 2025

cielo

	Size (cm)	Product code	Net weight (Kg)	Finishes	Euro	Pz.	Pz.
	Medidas Dimensions Maße Размеры	Artículo Article Artikel Артикул	Peso neto Poids net Reingewicht вес нетто	Acabados Finitions Farbe Отделки	Евро	шт. pallet Italia	шт. pallet Cont.
 <p>Wall-hung one hole bidet with fixing kit Bidé suspendido monoagujero completo con fijaciones / Bidet suspendu monotrou avec fixation / Wand-Bidet einloch mit Befestigungs kit / Биде подвесное с одним отверстием под смеситель, в комплекте с крепежами</p>	53 x 37 x h26	ITBS(X)*	21,50	<ul style="list-style-type: none">  Gloss White 451,00  *X = TL - Talco 561,00  *X = N - Gloss Black 649,00  *X = FU - Fumo 649,00  *X = TP - Talpa 649,00  Le Terre di Cielo * 649,00  Le Acque di Cielo 649,00 			
 <p>Impact and acoustic protection panel / Protección antigolpes y acústica / Protection acoustique et anti-choc / Stoss- und Schalldämmung / Противоударная и акустическая защита</p>		PAA	0,16		17,00		
 <p>Couple of fixing brackets for wall-hung wc/bidet - Pareja de estribo para Inodoro/Bidet suspendido / Étriers de fixation pour Wc/Bidet suspendus / 1 Paar Halterungen für wandhängendes Wc/Bidet / Монтажная рама для подвесного унитаза/биде</p>	3,3 x 18,5 x 55 h	508	2,00		39,00		
 <p>Universal click/clack drain in CHROME with ceramic lid Válvula universal click/clack Cromado con tapa en cerámica / Bonde universelle clic/clac Chromé avec clapet en céramique / Universal-Ablaufgarnitur Click-Clack Chrom mit Keramikstopfen / Универсальный донный клапан click/clack хром с керамической крышкой</p>		PIL01(X)*	0,40	<ul style="list-style-type: none">  Gloss White 95,00  *X = N - Gloss Black 114,00  *X = FU - Fumo 139,00  *X = TP- Talpa 139,00  Le Terre di Cielo 139,00  Le Acque di Cielo 139,00 			
 <p>Universal click/clack drain in BLACK MATT finish with ceramic lid Válvula universal click/clack Negro Matt con tapa en cerámica / Bonde universelle clic/clac Noir Mat avec clapet en céramique / Universal-Ablaufgarnitur Click-Clack Matt Schwarz mit Keramikstopfen / Универсальный донный клапан click/clack черный матовый с керамической крышкой</p>		PIL01NM(X)*	0,40	<ul style="list-style-type: none">  Gloss White 120,00  *X = N - Gloss Black 159,00  *X = FU - Fumo 169,00  *X = TP- Talpa 169,00  Le Terre di Cielo 169,00  Le Acque di Cielo 169,00 			
 <p>Universal click/clack drain in CEMENTO finish with ceramic lid Válvula universal click/clack Cemento con tapa en cerámica / Bonde universelle clic/clac Cemento avec clapet en céramique / Universal-Ablaufgarnitur Click-Clack Cement mit Keramikstopfen / Универсальный донный Cemento click/clack с керамической крышкой</p>		PIL01CM(X)*	0,40	<ul style="list-style-type: none">  Gloss White 120,00  *X = N - Gloss Black 159,00  *X = FU - Fumo 169,00  *X = TP- Talpa 169,00  Le Terre di Cielo 169,00  Le Acque di Cielo 169,00 			
 <p>Universal click/clack drain in BRONZE with ceramic lid Válvula universal click/clack Bronce con tapa en cerámica / Bonde / Universal-Ablaufgarnitur Click-Clack Bronze mit Keramikstopfen / Универсальный донный клапан click/clack бронза с керамической крышкой</p>		PIL01BR(X)*	0,40	<ul style="list-style-type: none">  Gloss White 135,00  *X = N - Gloss Black 171,00  *X = FU - Fumo 182,00  *X = TP- Talpa 182,00  Le Terre di Cielo 182,00  Le Acque di Cielo 182,00 			

CIELO RIMLESS 2.0.1®



Floor-standing wc with horizontal outlet convertible to floor outlet by technical curve (4,5 LT) - rimless 2.0.1 (including technical curve art. CSB27).

Wc con desagüe a pared convertible a suelo con curva técnica (4,5 LT) - sin brida - rimless 2.0.1 (incluida curva tecnica art. CSB27).

Wc avec évacuation murale transformable à terre avec courbe technique (4,5l) - sans bride - rimless 2.0.1 (courbe technique comprise, réf. CSB27).

WC mit Wandabfluss, durch Kurventechnik auf Bodenabfluss umrüstbar (4,5 LT) - ohne Spülrand - rimless 2.0.1 (einschließlich Rohrbogen Art. CSB27).

Слив в стену при помощи технического колена трансформируется на слив в пол (4,5 л) - без ободка - rimless 2.0.1 (включая техническую трубку арт. CSB27).

	Size (cm)	Product code	Net weight (Kg)	Finishes	Euro	Pz.	Pz.
	Medidas Dimensions Maße Размеры	Artículo Article Artikel Артикул	Peso neto Poinds net Reingewicht вес нетто	Acabados Finitions Farbe Отделки	Евро	шт. pallet Italia	шт. pallet Cont.
	53 x 37 x h42	ITVAK(X)*		<ul style="list-style-type: none"> Gloss White *X = TL - Talco *X = N - Gloss Black *X = FU - Fumo *X = TP - Talpa Le Terre di Cielo * Le Acque di Cielo 	561,00 693,00 781,00 781,00 781,00 781,00 781,00		
QUICK RELEASE HINGES							
Thermosetting seat & cover Asiento para inodoro Abattant thermodurcissable Wc-sitz thermodur Сиденье из термоотверждающейся смолы		CPVITT(X)*		Gloss White	110,00		
QUICK RELEASE HINGES							
Thermosetting soft close seat & cover Asiento para inodoro amortiguado Abattant thermodurcissable soft Wc-sitz thermodur mit Abs. Сиденье из термоотверждающейся смолы с плавным опусканием		CPVITTF(X)*		<ul style="list-style-type: none"> Gloss White *X = TL - Talco *X = N - Gloss Black *X = FU - Fumo *X = TP - Talpa Le Terre di Cielo * Le Acque di Cielo 	188,00 296,00 316,00 316,00 316,00 316,00 316,00		

Technical symbols legend

Simbolos técnicos clave | Légende symboles techniques | Technische Zeichenerklärung | Перечень технических символов

back to wall installation
instalación a suelo /
installation à terre /
bodenstehende Montage
напольная установка

with fixing parts
fijaciones incluidas /
fixations incluses /
inklusive Befestigungen
в комплекте с
креплениями

4,5 l toilet tank
descarga 4,5 lt /
évacuation à 4,5 l
4,5 l-Spülung / бачок
на 4,5 л

bifunctional drain
descarga bifuncional /
évacuation bifonctionnelle
Spülung mit zwei
Montagevarianten /
унифункциональный бачок

quick release hinge
sistema extraíble /
charnières à ouverture
Takeoff Funktion /
быстрый сьем

with overflow
con rebosadero / avec trop-
plein / mit Überlauf
с переливом

no tap holes
sin agujero para grifo
sans orifice robinet
ohne Hähnlloch
без отверстия под
смеситель

Acque di Cielo available for wc-bidet | Acque di Cielo
disponibles para wc-bidet | Acque di Cielo disponibles pour cuvette-
bidet | Für das WC/Bidet erhältliche Ausführungen Acque di Cielo |
Отделки Acque di Cielo доступны для унитаза и биде

OL - Oltremare SM - Smeraldo AL - Alga CO - Corallo NI - Ninfea AM - Anemone





































* Terre di Cielo finishes available for wc-bidet | Acabados
Terre di Cielo disponibles para wc-bidet | Finitions Terre di Cielo disponibles
pour cuvette-bidet | Für das WC/Bidet erhältliche Ausführungen Terre di
Cielo | отделки Terre di Cielo доступны для унитаза и биде

TL - Talco PM - Pomice BR - Brina AN - Arenaria AV - Avena CM - Cemento
 LN - Lino BA - Basalto LV - Lavagna

Itaca - bidet

Can be ordered from January 2025
 On peut le commander à partir de Janvier 2025
 Disponible para pedir a partir de Enero del 2025
 lieferbar ab Januar 2025
 доступно к заказу с января 2025

cielo

	Size (cm)	Product code	Net weight (Kg)	Finishes	Euro	Pz.	Pz.
	Medidas Dimensions Maße Размеры	Artículo Article Artikel Артикул	Peso neto Poids net Reingewicht вес нетто	Acabados Finitions Farbe Отделки	Евро	шт. pallet Italia	шт. pallet Cont.
 <p>Floor-standing bidet Bidé a suelo Bidet au sol Stand-Bidet Биде напольное</p>	53 x 37 x h42	ITBI(X)*		<ul style="list-style-type: none">  Gloss White 517,00  *X = TL - Talco 649,00  *X = N - Gloss Black 737,00  *X = FU - Fumo 737,00  *X = TP - Talpa 737,00  Le Terre di Cielo * 737,00  Le Acque di Cielo 737,00 			
 <p>Universal click/clack drain in CHROME with ceramic lid Válvula universal click/clack Cromado con tapa en cerámica Bonde universelle clic/clac Chromé avec clapet en céramique Universal-Ablaufgarnitur Click-Clack Chrom mit Keramikstopfen Универсальный донный клапан click/clack хром с керамической крышкой</p>		PIL01(X)*	0,40	<ul style="list-style-type: none">  Gloss White 95,00  *X = N - Gloss Black 114,00  *X = FU - Fumo 139,00  *X = TP - Talpa 139,00  Le Terre di Cielo 139,00  Le Acque di Cielo 139,00 			
 <p>Universal click/clack drain in BLACK MATT finish with ceramic lid / Válvula universal click/clack Negro Matt con tapa en cerámica / Bonde universelle clic/clac Noir Mat avec clapet en céramique Universal-Ablaufgarnitur Click-Clack Matt Schwarz mit Keramikstopfen Универсальный донный клапан click/clack черный матовый с керамической крышкой</p>		PIL01NM(X)*	0,40	<ul style="list-style-type: none">  Gloss White 120,00  *X = N - Gloss Black 159,00  *X = FU - Fumo 169,00  *X = TP - Talpa 169,00  Le Terre di Cielo 169,00  Le Acque di Cielo 169,00 			
 <p>Universal click/clack drain in CEMENTO finish with ceramic lid / Válvula universal click/clack Cemento con tapa en cerámica / Bonde universelle clic/clac Cemento avec clapet en céramique Universal-Ablaufgarnitur Click-Clack Cement mit Keramikstopfen Универсальный донный Cemento click/clack с керамической крышкой</p>		PIL01CM(X)*	0,40	<ul style="list-style-type: none">  Gloss White 120,00  *X = N - Gloss Black 159,00  *X = FU - Fumo 169,00  *X = TP - Talpa 169,00  Le Terre di Cielo 169,00  Le Acque di Cielo 169,00 			
 <p>Universal click/clack drain in BRONZE with ceramic lid Válvula universal click/clack Bronce con tapa en cerámica Bonde universelle clic/clac Bronze avec clapet en céramique Universal-Ablaufgarnitur Click-Clack Bronze mit Keramikstopfen Универсальный донный клапан click/clack бронза с керамической крышкой</p>		PIL01BR(X)*	0,40	<ul style="list-style-type: none">  Gloss White 135,00  *X = N - Gloss Black 171,00  *X = FU - Fumo 182,00  *X = TP - Talpa 182,00  Le Terre di Cielo 182,00  Le Acque di Cielo 182,00 			

Can be ordered from January 2025

On peut le commander à partir de Janvier 2025











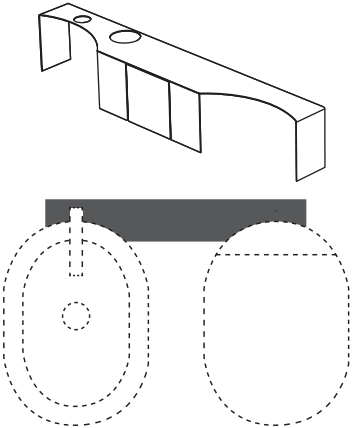





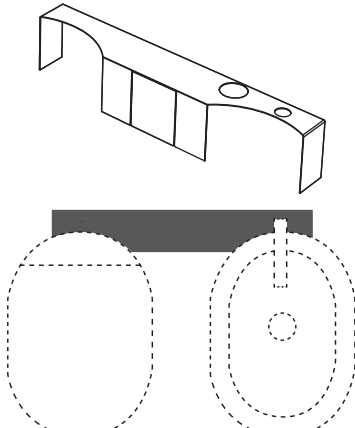

Disponibile para pedir a partir de Enero del 2025



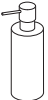







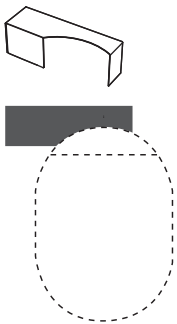





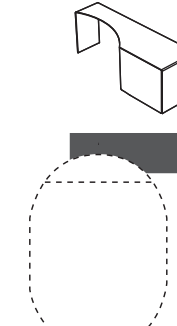





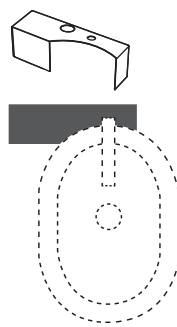

lieferbar ab Januar 2025

доступно к заказу с января 2025

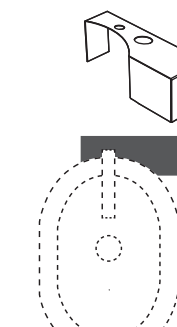
Itaca - accessories

cielo

	Size (cm) Medidas Dimensions Maße Размеры	Product code Artículo Article Artikel Артикул	Net weight (Kg) Peso neto Poids net Reingewicht вес нетто	Finishes Acabados Finitions Farbe Отделки	Euro Евро
<p>Integrated fitting in stainless steel for Itaca floor-standing WC and bidet, with tap hole, housing for dispenser and toilet roll holder, left version.</p> <p>Accesorio en acero inoxidable integrado para wc y bidet a suelo Itaca, con orificio griferia, espacio para dispensador y portarrollo, versión izquierda. Accessoire en acier inoxydable intégré pour WC et bidet sur pied Itaca, avec trou de robinetterie, logement pour distributeur et porte rouleau, version gauche. Kombiniertes Zubehör aus edelstahl für bodenstehendes WC und Bidet Itaca, mit Hahnloch, Aufnahme für Spender und Rollenhalter, Ausführung links. Аксессуар из нержавеющей интегрированный для напольного унитаза и биде Itaca, с отверстием под смеситель, подставка под диспенсер и полотенцедержатель, левосторонний.</p>	74 x 12 x h13	ITMBWSX(x)* ITMBWSXSF(x)* no tap hole sin agujero sans orifice ohne Loch без отверстия		<ul style="list-style-type: none">  Le Acque di Cielo 469,00  *X = FU - Fumo 469,00  *X = TP - Talpa 469,00  *X = NM - Matt Black 442,00  *X = CM - Cemento 455,00 	
 <p>Integrated fitting in stainless steel for Itaca floor-standing WC and bidet, with tap hole, housing for dispenser and toilet roll holder, right version.</p> <p>Accesorio en acero inoxidable integrado para wc y bidet a suelo Itaca, con orificio griferia, espacio para dispensador y portarrollo, versión derecha. Accessoire en acier inoxydable intégré pour WC et bidet sur pied Itaca, avec trou de robinetterie, logement pour distributeur et porte rouleau, version droite. Kombiniertes Zubehör aus edelstahl für bodenstehendes WC und Bidet Itaca, mit Hahnloch, Aufnahme für Spender und Rollenhalter, Ausführung rechts. Аксессуар из нержавеющей интегрированный для напольного унитаза и биде Itaca, с отверстием под смеситель, подставка под диспенсер и полотенцедержатель, правосторонний.</p>	74 x 12 x h13	ITMBWDX(x)* ITMBWDXSF(x)* no tap hole sin agujero sans orifice ohne Loch без отверстия		<ul style="list-style-type: none">  Le Acque di Cielo 469,00  *X = FU - Fumo 469,00  *X = TP - Talpa 469,00  *X = NM - Matt Black 442,00  *X = CM - Cemento 455,00 	
 <p>Metal dispenser Dispensador de metal \ Distributeur en métal \ Spender aus Metall \ Диспенсер из металла</p>	Ø6 x 18 h	ACDIM(x)*	0,50	<ul style="list-style-type: none">  Le Acque di Cielo 229,00  *X = FU - Fumo 229,00  *X = TP - Talpa 229,00  *X = NM - Matt Black 204,00  *X = CM - Cemento 204,00 	

	Size (cm)	Product code	Net weight(Kg)	Finishes	Euro
	Medidas Dimensions Maße Размеры	Artículo Article Artikel Артикул	Peso neto Poids net Reingewicht вес нетто	Acabados Finitions Farbe Отделки	Евро
 <p>Fitting in stainless steel, for Itaca floor-standing WC, with toilet roll holder on the left. Accesorio en acero inoxidable para wc a suelo Itaca, con portarrollo a la izquierda. Accessoire en acier inoxydable pour WC sur pied Itaca, avec porte rouleau à gauche. Zubehör aus edelstahl für bodenstehendes WC Itaca, mit Rollenhalter links. Аксессуар из нержавеющей стали для напольного унитаза Itaca, с левосторонним бумагодержателем.</p>	38 x 12 x h13	ITMWSX(X)*		<ul style="list-style-type: none">  Le Acque di Cielo 383,00  *X = FU - Fumo 383,00  *X = TP - Talpa 383,00  *X = NM - Matt Black 356,00  *X = CM - Cemento 370,00 	
 <p>Fitting in stainless steel, for Itaca floor-standing WC, with toilet roll holder on the right. Accesorio en acero inoxidable para wc a suelo Itaca, con portarrollo a la derecha. Accessoire en acier inoxydable pour WC sur pied Itaca, avec porte rouleau à droite. Zubehör aus edelstahl für bodenstehendes WC Itaca, mit Rollenhalter rechts. Аксессуар из нержавеющей для напольного унитаза Itaca, с правосторонним бумагодержателем.</p>	38 x 12 x h13	ITMWDX(X)*		<ul style="list-style-type: none">  Le Acque di Cielo 383,00  *X = FU - Fumo 383,00  *X = TP - Talpa 383,00  *X = NM - Matt Black 356,00  *X = CM - Cemento 370,00 	
 <p>Fitting in stainless steel for Itaca floor-standing bidet, with tap hole and housing for dispenser, left version. Accesorio en acero inoxidable para bidet a suelo Itaca, con orificio griferia y espacio para dispensador a la izquierda. Accessoire en acier inoxydable pour bidet sur pied Itaca, avec trou de robinetterie et logement pour distributeur à gauche. Zubehör aus edelstahl für bodenstehendes Bidet Itaca, mit Hahnloch und Aufnahme für Spender links. Аксессуар из нержавеющей для напольного биде Itaca, с отверстием под смеситель и подставкой под диспенсер, левосторонний.</p>	38 x 12 x h13	ITMBSX(X)* ITMBSXSF(X)* <small>no tap hole sin agujero sans orifice ohne Loch без отверстия</small>		<ul style="list-style-type: none">  Le Acque di Cielo 383,00  *X = FU - Fumo 383,00  *X = TP - Talpa 383,00  *X = NM - Matt Black 356,00  *X = CM - Cemento 370,00 	
 <p>Fitting in stainless steel for Itaca floor-standing bidet, with tap hole and housing for dispenser, right version. Accesorio en acero inoxidable para bidet a suelo Itaca, con orificio griferia y espacio par dispensador a la derecha. Accessoire en acier inoxydable pour bidet sur pied Itaca, avec trou de robinetterie et logement pour distributeur à droite. Zubehör aus edelstahl für bodenstehendes Bidet Itaca, mit Hahnloch und Aufnahme für Spender rechts. Аксессуар из нержавеющей для напольного биде Itaca, с отверстием под смеситель и подставкой под диспенсер, правосторонний.</p>	38 x 12 x h13	ITMBDX(X)* ITMBDXSF(X)* <small>no tap hole sin agujero sans orifice ohne Loch без отверстия</small>		<ul style="list-style-type: none">  Le Acque di Cielo 383,00  *X = FU - Fumo 383,00  *X = TP - Talpa 383,00  *X = NM - Matt Black 356,00  *X = CM - Cemento 370,00 	

		Product code	Net weight (Kg)	Finishes	Euro
		Artículo Article Artikel Артикул	Peso neto Poids net Reingewicht вес нетто	Acabados Finitions Farbe Отделки	Евро
	Water inlet connection Conexión para entrada de agua. Raccord d'entrée d'eau. Anschlussstück Wasserzulauf. Патрубок для подачи воды.	REA		● Glossy Black	13,00
	Off-centre connection max ± 1.5 cm for ground or wall drainage Tubo trasero excéntrico máx ± 1,5 cm para entrada de agua. Tube excentrique ± 1,5 cm max à l'arrière de la cuvette pour l'entrée de l'eau. Rohr WC-Rückseite, exzentrisch, max. ± 1,5 cm, für Wasserzulauf. Задняя трубка эксцентрик макс. ± 1,5 см для подачи воды.	RSEN	0,10	● Glossy Black	22,00
	Straight pan connector for wall trap Anclaje a pared para inodoro Pipe pour sortie horizontale WC-Anschlussstutzen für Abgang waagerecht Фитинг для выпуска в стену для унитазов	RPBN		● Glossy Black	26,00
	Off-centre connection max ± 4 cm for ground drainage Conexión excéntrica máx ± 4 cm. para desagüe a suelo. Raccord excentrique ± 4 cm max pour l'évacuation au sol. Anschlussstück exzentrisch, max. ± 4 cm, für oder Standausführung. Соединение эксцентрик макс ± 4 см для слива в пол.	RSE4			30,00
	High technical S-bend for floor drainage Curva técnica a "S" alta para descarga a suelo. Courbe technique haute en « S » pour l'évacuation au sol. "S"-Rohrbogen, hoch, für Spülkasten in Standausführung. Техническая трубка «S» высокая для слива в пол.	CSTR27			43,00
	Adjustable 90° high technical bend Curva técnica alta a 90° regulable. Courbe technique haute réglable à 90°. 90°-Rohrbogen, hoch, einstellbar. Регулируемая техническая трубка высокая на 90°.	CSR9027			40,00
	Compact high technical S-bend Curva técnica a "S" alta compacta. Courbe technique haute et compacte en « S ». "S"-Rohrbogen, hoch, kompakt. Компактная техническая трубка «S».	CSB27			26,00



Kanto



design Giuseppe Pezzano e Andrea Parisio

indice collezione \ collection index pg. 89
modulo d'ordine \ order form pg. 92 - 101
listino prezzi \ price list pg. 102 - 113

Washbasin, shelf and top finishes

Acabados de Lavabos, estante, top \ Finitions des Lavabos, tablette, plan \ Waschbecken - Konsole - Platte Farbe \ Отделки - Полочка - столешница Раковина

Essential Colors

-  Gloss White
-  Gloss Black
-  FU - Fumo **NEW**
-  TP - Talpa **NEW**

Le Terre di Cielo



-  TL - Talco
-  PM - Pomice
-  BR - Brina
-  CM - Cemento
-  BA - Basalto
-  LV - Lavagna
-  FN - Fango
-  CA - Cacao
-  AN - Arenaria
-  AV - Avena
-  MU - Muschio
-  AG - Agave
-  LN - Lino
-  CN - Canapa
-  CP - Cipria
-  PL - Polvere

Le Acque di Cielo

-  OL - Oltremare
-  SM - Smeraldo
-  AL - Alga
-  CO - Corallo
-  NI - Ninfea
-  AM - Anemone

Cabinet finishes

Acabados para mueble \ finitions pour le meuble | Für Möbel Farbe | отделка доступна для ящика

-  FU - Fumo **NEW**
-  TP - Talpa **NEW**

Le Terre di Cielo

-  TL - Talco
-  PM - Pomice
-  BR - Brina
-  CM - Cemento
-  BA - Basalto
-  AN - Arenaria
-  AV - Avena
-  MU - Muschio
-  AG - Agave **NEW**

Essenze

-  Rovere Sbiancato
-  Rovere Naturale
-  Rovere Nero
-  Rovere Tinto Noce **NEW**
-  Eucalipto

Le Acque di Cielo

-  OL - Oltremare
-  SM - Smeraldo
-  AL - Alga
-  CO - Corallo
-  NI - Ninfea
-  AM - Anemone

The possible variations of the colour cannot be considered as defect, but as a guarantee of the completely artisan manufacturing of this unique and high quality product. / Las variaciones de colores no se consideran un defecto sino una garantía de una elaboración manual y artesanal en un producto único y de calidad. / Les éventuelles variations de couleur ne peuvent être considérées comme des défauts, elles témoignent en revanche d'une méthode de travail totalement manuelle et artisanale employée pour obtenir un produit fini unique et de qualité. / Eventuelle Farbvariationen sind nicht als Mangel anzusehen, sondern als Garantie für die komplett handwerkliche Anfertigung eines einzigartigen und hochqualitativen Produkts. / Возможные вариации цвета не могут считаться дефектом, а являются подтверждением ручной работы, гарантией качества и уникальности изделия.

Lavabo / washbasin

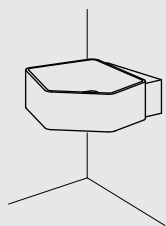

KALS
50 x 52 x 15 h
pag. 102

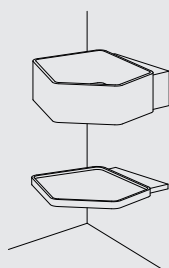

lavabo con mensola
Kanto with shelf
pag. 102

Lavabi con mobile / washbasins with cabinet

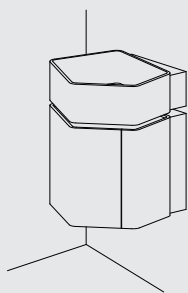

lavabo con mobile 50
Kanto 50 cabinet
pag. 104

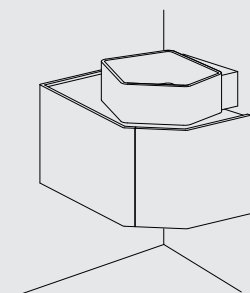

lavabo con mobile 87
Kanto 87 cabinet
pag. 108

Specchi / mirrors

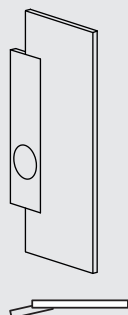

specchio versione sinistra
Kanto mirror - left version
pag. 112

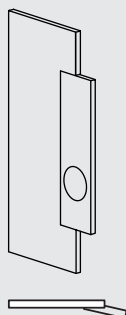

specchio versione destra
Kanto mirror - right mirror
pag. 112





modelli disponibili / available models

KANTO collection

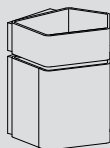

Kanto mobile 50
Kanto cabinet 50



finiture / finishes

LAVABO IN CERAMICA / CERAMIC WASHBASIN AND TOP

Le Terre di Cielo

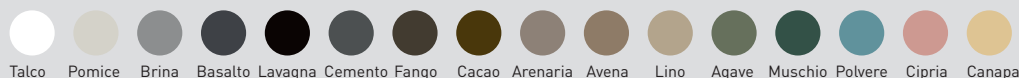

Le Acque di Cielo



Essential colors



KALS
KALSSF

MOBILE IN LEGNO / WOODEN CABINET

laccature / lacquers

Le Terre di Cielo

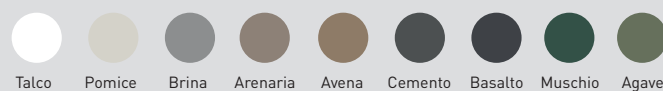

Le Acque di Cielo

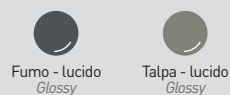

essenze / wooden finishes

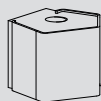
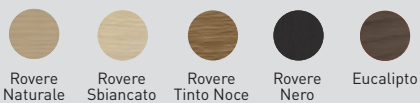

KAM50L
KAM50E

note tecniche lavabo / washbasin technical notes



monoforo
one tap hole



senza foro su richiesta
no tap hole on request



con un lato non smaltato
one side is unglazed



senza troppopieno, con troppopieno su richiesta
without overflow, overflow on request



installazione sospesa
wall-hung installation



installazione da appoggio
on top installation

CLIENTE/client: ORD. REF.:

QUANTITA'/quantity: EMAIL:

INDICARE CON UN SEGNO LE FINITURE SCELTE PER I DIVERSI COMPONENTI

INDICATE WITH A TICK, THE CHOOSEN FINISHES FOR ALL THE COMPONENTS

art. **KALS/KALSSF**

art. **KAM50L/KAM50E**

FINITURE LAVABO
WASHBASIN FINISHES

Essential Colors

- Bianco/white - glossy
- N - Nero/black - glossy
- FU - Fumo - glossy
- TP - Talpa - glossy

Le Terre di Cielo

<input type="radio"/> TL - Talco	<input type="radio"/> AN - Arenaria
<input type="radio"/> PM - Pomice	<input type="radio"/> AV - Avena
<input type="radio"/> BR - Brina	<input type="radio"/> LN - Lino
<input type="radio"/> BA - Basalto	<input type="radio"/> AG - Agave
<input type="radio"/> LV - Lavagna	<input type="radio"/> MU - Muschio
<input type="radio"/> CM - Cemento	<input type="radio"/> PL - Polvere
<input type="radio"/> FN - Fango	<input type="radio"/> CP - Cipria
<input type="radio"/> CA - Cacao	<input type="radio"/> CN - Canapa

Le Acque di Cielo

<input type="radio"/> OL - Oltremare	<input type="radio"/> CO - Corallo
<input type="radio"/> SM - Smeraldo	<input type="radio"/> NI - Ninfea
<input type="radio"/> AL - Alga	<input type="radio"/> AM - Anemone

FINITURE MOBILE IN LEGNO
WOODEN CABINET FINISHES

laccature/laquerings

<input type="radio"/> TL - Talco	<input type="radio"/> AV - Avena
<input type="radio"/> PM - Pomice	<input type="radio"/> CM - Cemento
<input type="radio"/> BR - Brina	<input type="radio"/> BA - Basalto
<input type="radio"/> AN - Arenaria	<input type="radio"/> MU - Muschio
<input type="radio"/> AG - Agave	

Le Acque di Cielo

<input type="radio"/> OL - Oltremare	<input type="radio"/> CO - Corallo
<input type="radio"/> SM - Smeraldo	<input type="radio"/> NI - Ninfea
<input type="radio"/> AL - Alga	<input type="radio"/> AM - Anemone

FU - Fumo

TP - Talpa

essenze legno/wood essences

<input type="radio"/> RO - Rovere Nero
<input type="radio"/> RT - Rovere Tinto noce
<input type="radio"/> RS - Rovere Sbiancato
<input type="radio"/> RN - Rovere Naturale
<input type="radio"/> EU - Eucalipto

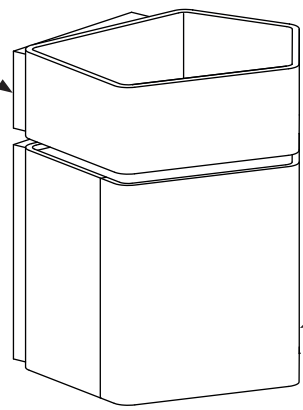

SENZA TROPPOPIENO
WITHOUT OVERFLOW



CON TROPPOPIENO SU RICHIESTA
Attenzione: il foro del troppo pieno è decentrato rispetto al foro pileta e al foro rubinetto.
WITH OVERFLOW ON REQUEST
Attention: the overflow hole is off-center with respect to the waste hole and the tap hole.

N.B.
Il lavabo è monoforo, su richiesta può essere prodotto senza foro.

N.B.
The washbasin has 1 hole; may be made without holes upon request

DATA
DATE _____

ATTENZIONE:
La rappresentazione delle finiture è puramente indicativa. Verificare le finiture con le relative cartelle.

Ogni oggetto possiede la peculiarità di essere elaborato secondo principi puramente tradizionali, in modo da garantirne l'assoluta originalità ed unicità. Le eventuali piccole variazioni di colore, tono o venature fra gli articoli sono da considerarsi pregi e non difetti, in quanto garanzia della fattura manuale del prodotto, che fa di ogni oggetto Cielo un pezzo unico ed esclusivo, lontano dall'omologazione industriale. In fase d'ordine si intendono, pertanto, accettate tali tolleranze che non possono dare adito a contestazioni di alcun genere.

Verificare sempre le disponibilità e i tempi di consegna con il commerciale.

FIRMA DEL CLIENTE
SIGNATURE _____

ATTENTION:
The representation of the finishes is merely indicative. Please choose the finishes using the folders.

Every item possesses that particular feature of being processed according to purely traditional principles that guarantee its absolute originality and uniqueness. The small variations in colour, hues or streaks on the items are to be considered as qualities and not defects, since they warranty the handcrafted processing which makes each Cielo item a unique and exclusive piece that cannot be compared to industrial standardization. When making the order, the client implicitly accepts those various features that may give rise to claims of any sort.

Always check the availability and delivery time with the commercial department.

modelli disponibili / available models

KANTO

collection

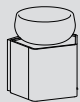

**Kanto mobile 50 con
bacinella Tino**
Kanto cabinet 50 with Tino
bowl



**Kanto mobile 50 con
bacinella Era Small**
Kanto cabinet 50 with Era
Small bowl

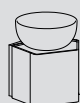

**Kanto mobile 50 con
bacinella Shui 40**
Kanto cabinet 50 with
Shui 40 bowl



finiture / finishes



BATO



BAERA40



SHBA40



KAPI50

LAVABO E TOP IN CERAMICA / CERAMIC WASHBASIN AND TOP

Le Terre di Cielo

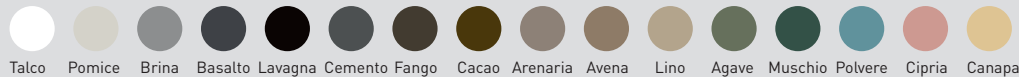

Le Acque di Cielo



Essential colors



MOBILE IN LEGNO / WOODEN CABINET

laccature / lacquers

Le Terre di Cielo



Le Acque di Cielo



essenze / wooden finishes

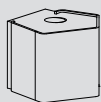
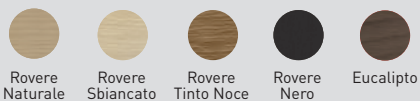

KAM50L
KAM50E

note tecniche lavabo / washbasin technical notes



senza foro
no tap holes



con tutti i lati smaltati
all sides are enamelled



senza troppopieno
without overflow



installazione da appoggio
on top installation

Modulo Ordine Kanto mobile 50

Kanto cabinet 50 Order Form

cielo

CLIENTE/client: ORD. REF.:

QUANTITA'/quantity: EMAIL:

INDICARE CON UN SEGNO LE FINITURE SCELTE PER I DIVERSI COMPONENTI

INDICATE WITH A TICK, THE CHOSEN FINISHES FOR ALL THE COMPONENTS

Tino

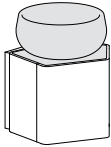

Kanto mobile 50 con bacinella Tino
Kanto cabinet 50 with Tino bowl

Era Small

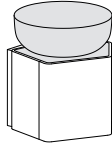

Kanto mobile 50 con bacinella Era Small
Kanto cabinet 50 with Era Small bowl

Shui 40

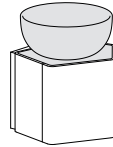

Kanto mobile 50 con bacinella Shui 40
Kanto cabinet 50 with Shui 40 bowl

art. **KAPI50**

FINITURE TOP

TOP FINISHES

Essential Colors

- Bianco/white - glossy
- N - Nero/black - glossy
- FU - Fumo - glossy
- TP - Talpa - glossy

Le Terre di Cielo

- | | |
|---------------------------------------|--|
| <input type="checkbox"/> TL - Talco | <input type="checkbox"/> AN - Arenaria |
| <input type="checkbox"/> PM - Pomice | <input type="checkbox"/> AV - Avena |
| <input type="checkbox"/> BR - Brina | <input type="checkbox"/> LN - Lino |
| <input type="checkbox"/> BA - Basalto | <input type="checkbox"/> AG - Agave |
| <input type="checkbox"/> LV - Lavagna | <input type="checkbox"/> MU - Muschio |
| <input type="checkbox"/> CM - Cemento | <input type="checkbox"/> PL - Polvere |
| <input type="checkbox"/> FN - Fango | <input type="checkbox"/> CP - Cipria |
| <input type="checkbox"/> CA - Cacao | <input type="checkbox"/> CN - Canapa |

Le Acque di Cielo

- | | |
|---|---------------------------------------|
| <input type="checkbox"/> OL - Oltremare | <input type="checkbox"/> CO - Corallo |
| <input type="checkbox"/> SM - Smeraldo | <input type="checkbox"/> NI - Ninfea |
| <input type="checkbox"/> AL - Alga | <input type="checkbox"/> AM - Anemone |

FINITURE LAVABO

WASHBASIN FINISHES

Essential Colors

- Bianco/white - glossy
- N - Nero/black - glossy
- FU - Fumo - glossy
- TP - Talpa - glossy

Le Terre di Cielo

- | | |
|---------------------------------------|--|
| <input type="checkbox"/> TL - Talco | <input type="checkbox"/> AN - Arenaria |
| <input type="checkbox"/> PM - Pomice | <input type="checkbox"/> AV - Avena |
| <input type="checkbox"/> BR - Brina | <input type="checkbox"/> LN - Lino |
| <input type="checkbox"/> BA - Basalto | <input type="checkbox"/> AG - Agave |
| <input type="checkbox"/> LV - Lavagna | <input type="checkbox"/> MU - Muschio |
| <input type="checkbox"/> CM - Cemento | <input type="checkbox"/> PL - Polvere |
| <input type="checkbox"/> FN - Fango | <input type="checkbox"/> CP - Cipria |
| <input type="checkbox"/> CA - Cacao | <input type="checkbox"/> CN - Canapa |

Le Acque di Cielo

- | | |
|---|---------------------------------------|
| <input type="checkbox"/> OL - Oltremare | <input type="checkbox"/> CO - Corallo |
| <input type="checkbox"/> SM - Smeraldo | <input type="checkbox"/> NI - Ninfea |
| <input type="checkbox"/> AL - Alga | <input type="checkbox"/> AM - Anemone |

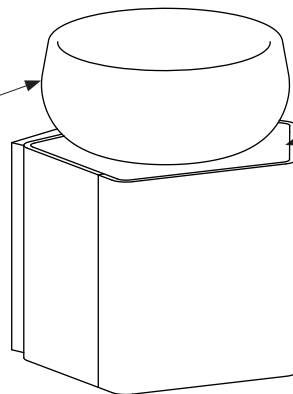

art. **KAM50L/KAM50E**

FINITURE MOBILE IN LEGNO

WOODEN CABINET FINISHES

laccature/laquerings

- | | | |
|--|---------------------------------------|-------------------------------------|
| <input type="checkbox"/> TL - Talco | <input type="checkbox"/> AV - Avena | <input type="checkbox"/> FU - Fumo |
| <input type="checkbox"/> PM - Pomice | <input type="checkbox"/> CM - Cemento | <input type="checkbox"/> TP - Talpa |
| <input type="checkbox"/> BR - Brina | <input type="checkbox"/> BA - Basalto | |
| <input type="checkbox"/> AN - Arenaria | <input type="checkbox"/> MU - Muschio | |
| <input type="checkbox"/> AG - Agave | | |

essenze legno/wood essences

Le Acque di Cielo

- | | | |
|---|---------------------------------------|---|
| <input type="checkbox"/> OL - Oltremare | <input type="checkbox"/> CO - Corallo | <input type="checkbox"/> R0 - Rovere Nero |
| <input type="checkbox"/> SM - Smeraldo | <input type="checkbox"/> NI - Ninfea | <input type="checkbox"/> RT - Rovere Tinto noce |
| <input type="checkbox"/> AL - Alga | <input type="checkbox"/> AM - Anemone | <input type="checkbox"/> RS - Rovere Sbiancato |
| | | <input type="checkbox"/> RN - Rovere Naturale |
| | | <input type="checkbox"/> EU - Eucalipto |

DATA

DATE _____

ATTENZIONE:

La rappresentazione delle finiture è puramente indicativa. Verificare le finiture con le relative cartelle.

Ogni oggetto possiede la peculiarità di essere elaborato secondo principi puramente tradizionali, in modo da garantirne l'assoluta originalità ed unicità. Le eventuali piccole variazioni di colore, tono o venature fra gli articoli sono da considerarsi pregi e non difetti, in quanto garanzia della fattura manuale del prodotto, che fa di ogni oggetto Cielo un pezzo unico ed esclusivo, lontano dall'omologazione industriale. In fase d'ordine si intendono, pertanto, accettate tali tolleranze che non possono dare adito a contestazioni di alcun genere.

Verificare sempre le disponibilità e i tempi di consegna con il commerciale.

FIRMA DEL CLIENTE

SIGNATURE _____

ATTENTION:

The representation of the finishes is merely indicative. Please choose the finishes using the folders.

Every item possesses that particular feature of being processed according to purely traditional principles that guarantee its absolute originality and uniqueness. The small variations in colour, hues or streaks on the items are to be considered as qualities and not defects, since they warranty the handcrafted processing which makes each Cielo item a unique and exclusive piece that cannot be compared to industrial standardization. When making the order, the client implicitly accepts those various features that may give rise to claims of any sort.

Always check the availability and delivery time with the commercial department.

modelli disponibili / available models

KANTO

collection

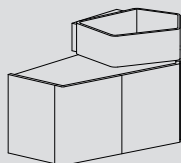

Kanto mobile 87
Kanto cabinet 87



finiture / finishes

LAVABO IN CERAMICA / CERAMIC WASHBASIN AND TOP



KALS
KALSSF

Le Terre di Cielo



Le Acque di Cielo



Essential colors

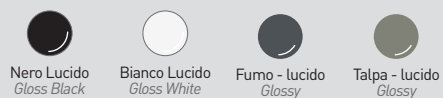

KAPI87

MOBILE IN LEGNO / WOODEN CABINET

laccature / lacquers

Le Terre di Cielo



Le Acque di Cielo

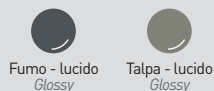

essenze / wooden finishes

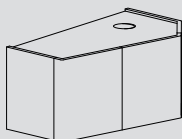
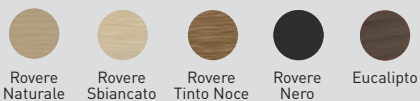

KAM87L
KAM87E

note tecniche lavabo / washbasin technical notes



monoforo
one tap hole



senza foro su richiesta
no tap hole on request



con un lato non smaltato
one side is unglazed



senza troppopieno, con troppopieno su richiesta
without overflow, overflow on request



installazione sospesa
wall-hung installation



installazione da appoggio
on top installation

CLIENTE/client: ORD. REF.:

QUANTITA'/quantity: EMAIL:

INDICARE CON UN SEGNO LE FINITURE SCELTE PER I DIVERSI COMPONENTI

INDICATE WITH A TICK, THE CHOOSEN FINISHES FOR ALL THE COMPONENTS

art. **KAPI87**

FINITURE TOP
TOP FINISHES

Essential Colors

- Bianco/white - glossy
- N - Nero/black - glossy
- FU - Fumo - glossy
- TP - Talpa - glossy

Le Terre di Cielo

<input type="radio"/> TL - Talco	<input type="radio"/> AN - Arenaria
<input type="radio"/> PM - Pomice	<input type="radio"/> AV - Avena
<input type="radio"/> BR - Brina	<input type="radio"/> LN - Lino
<input type="radio"/> BA - Basalto	<input type="radio"/> AG - Agave
<input type="radio"/> LV - Lavagna	<input type="radio"/> MU - Muschio
<input type="radio"/> CM - Cemento	<input type="radio"/> PL - Polvere
<input type="radio"/> FN - Fango	<input type="radio"/> CP - Cipria
<input type="radio"/> CA - Cacao	<input type="radio"/> CN - Canapa

Le Acque di Cielo

<input type="radio"/> OL - Oltremare	<input type="radio"/> CO - Corallo
<input type="radio"/> SM - Smeraldo	<input type="radio"/> NI - Ninfea
<input type="radio"/> AL - Alga	<input type="radio"/> AM - Anemone

art. **KALS/KALSSF**

FINITURE LAVABO

WASHBASIN FINISHES

Essential Colors

- Bianco/white - glossy
- N - Nero/black - glossy
- FU - Fumo - glossy
- TP - Talpa - glossy

Le Terre di Cielo

- | | |
|------------------------------------|-------------------------------------|
| <input type="radio"/> TL - Talco | <input type="radio"/> AN - Arenaria |
| <input type="radio"/> PM - Pomice | <input type="radio"/> AV - Avena |
| <input type="radio"/> BR - Brina | <input type="radio"/> LN - Lino |
| <input type="radio"/> BA - Basalto | <input type="radio"/> AG - Agave |
| <input type="radio"/> LV - Lavagna | <input type="radio"/> MU - Muschio |
| <input type="radio"/> CM - Cemento | <input type="radio"/> PL - Polvere |
| <input type="radio"/> FN - Fango | <input type="radio"/> CP - Cipria |
| <input type="radio"/> CA - Cacao | <input type="radio"/> CN - Canapa |

Le Acque di Cielo

- | | |
|--------------------------------------|------------------------------------|
| <input type="radio"/> OL - Oltremare | <input type="radio"/> CO - Corallo |
| <input type="radio"/> SM - Smeraldo | <input type="radio"/> NI - Ninfea |
| <input type="radio"/> AL - Alga | <input type="radio"/> AM - Anemone |

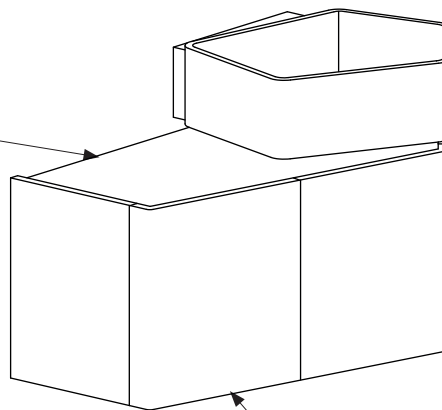

art. **KAM87L/KAM87E**

FINITURE MOBILE IN LEGNO

WOODEN CABINET FINISHES

laccature/laquerings

- | | | |
|-------------------------------------|------------------------------------|----------------------------------|
| <input type="radio"/> TL - Talco | <input type="radio"/> AV - Avena | <input type="radio"/> FU - Fumo |
| <input type="radio"/> PM - Pomice | <input type="radio"/> CM - Cemento | <input type="radio"/> TP - Talpa |
| <input type="radio"/> BR - Brina | <input type="radio"/> BA - Basalto | |
| <input type="radio"/> AN - Arenaria | <input type="radio"/> MU - Muschio | |
| <input type="radio"/> AG - Agave | | |

essenze legno/wood essences

Le Acque di Cielo

- | | | |
|--------------------------------------|------------------------------------|--|
| <input type="radio"/> OL - Oltremare | <input type="radio"/> CO - Corallo | <input type="radio"/> RO - Rovere Nero |
| <input type="radio"/> SM - Smeraldo | <input type="radio"/> NI - Ninfea | <input type="radio"/> RT - Rovere Tinto noce |
| <input type="radio"/> AL - Alga | <input type="radio"/> AM - Anemone | <input type="radio"/> RS - Rovere Sbiancato |
| | | <input type="radio"/> RN - Rovere Naturale |
| | | <input type="radio"/> EU - Eucalipto |



SENZA TROPPOPIENO
WITHOUT OVERFLOW

N.B.
Il lavabo è monoforo, su richiesta può essere prodotto senza foro.



CON TROPPOPIENO SU RICHIESTA
Attenzione: il foro del troppo pieno è decentrato rispetto al foro piletta e al foro rubinetto.
WITH OVERFLOW ON REQUEST
Attention: the overflow hole is off-center with respect to the waste hole and the tap hole.

N.B.
The washbasin has 1 hole; may be made without holes upon request

DATA

DATE _____

ATTENZIONE:
La rappresentazione delle finiture è puramente indicativa. Verificare le finiture con le relative cartelle.

Ogni oggetto possiede la peculiarità di essere elaborato secondo principi puramente tradizionali, in modo da garantirne l'assoluta originalità ed unicità. Le eventuali piccole variazioni di colore, tono o venature fra gli articoli sono da considerarsi pregi e non difetti, in quanto garanzia della fattura manuale del prodotto, che fa di ogni oggetto Cielo un pezzo unico ed esclusivo, lontano dall'omologazione industriale. In fase d'ordine si intendono, pertanto, accettate tali tolleranze che non possono dare adito a contestazioni di alcun genere.

Verificare sempre le disponibilità e i tempi di consegna con il commerciale.

FIRMA DEL CLIENTE

SIGNATURE _____

ATTENTION:
The representation of the finishes is merely indicative. Please choose the finishes using the folders.

Every item possesses that particular feature of being processed according to purely traditional principles that guarantee its absolute originality and uniqueness. The small variations in colour, hues or streaks on the items are to be considered as qualities and not defects, since they warranty the handcrafted processing which makes each Cielo item a unique and exclusive piece that cannot be compared to industrial standardization. When making the order, the client implicitly accepts those various features that may give rise to claims of any sort.

Always check the availability and delivery time with the commercial department.

modelli disponibili / available models

KANTO
collection

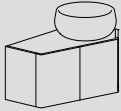

**Kanto mobile 87 con
bacinella Tino**
Kanto cabinet 87 with Tino
bowl

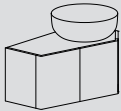

**Kanto mobile 87 con
bacinella Era Small**
Kanto cabinet 87 with Era
Small bowl

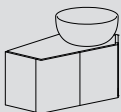

**Kanto mobile 87 con
bacinella Shui 40**
Kanto cabinet 87 with
Shui 40 bowl



finiture / finishes



BATO



BAERA40



SHBA40



KAPI87

LAVABO IN CERAMICA / CERAMIC WASHBASIN AND TOP

Le Terre di Cielo

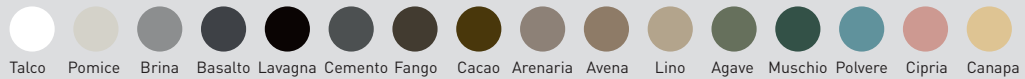

Le Acque di Cielo



Essential colors

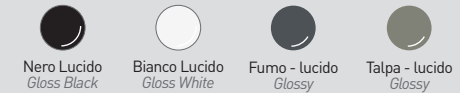

MOBILE IN LEGNO / WOODEN CABINET

laccature / lacquers

Le Terre di Cielo



Le Acque di Cielo

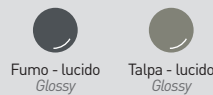

essenze / wooden finishes

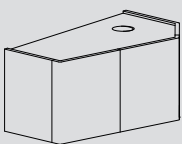
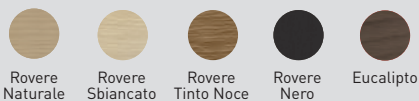

KAM87L
KAM87E

note tecniche lavabo / washbasin technical notes



senza foro
no tap holes



con tutti i lati smaltati
all sides are enamelled



senza troppopieno
without overflow



installazione da appoggio
on top installation

Modulo Ordine Kanto mobile 87

Kanto cabinet 87 Order Form

cielo

CLIENTE/client: ORD. REF.:

QUANTITA'/quantity: EMAIL:

INDICARE CON UN SEGNO LE FINITURE SCELTE PER I DIVERSI COMPONENTI

INDICATE WITH A TICK, THE CHOSEN FINISHES FOR ALL THE COMPONENTS

Tino

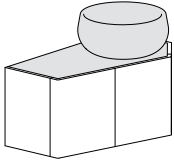

Kanto mobile 87 con bacinella Tino
Kanto cabinet 87 with Tino bowl

Era Small

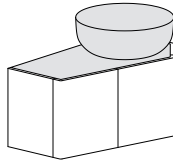

Kanto mobile 87 con bacinella Era Small
Kanto cabinet 87 with Era Small bowl

Shui 40

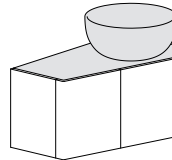

Kanto mobile 87 con bacinella Shui 40
Kanto cabinet 87 with Shui 40 bowl

art. **KAPI87**

FINITURE TOP

TOP FINISHES

Essential Colors

- Bianco/white - glossy
- N - Nero/black - glossy
- FU - Fumo - glossy
- TP - Talpa - glossy

Le Terre di Cielo

- | | |
|---------------------------------------|--|
| <input type="checkbox"/> TL - Talco | <input type="checkbox"/> AN - Arenaria |
| <input type="checkbox"/> PM - Pomice | <input type="checkbox"/> AV - Avena |
| <input type="checkbox"/> BR - Brina | <input type="checkbox"/> LN - Lino |
| <input type="checkbox"/> BA - Basalto | <input type="checkbox"/> AG - Agave |
| <input type="checkbox"/> LV - Lavagna | <input type="checkbox"/> MU - Muschio |
| <input type="checkbox"/> CM - Cemento | <input type="checkbox"/> PL - Polvere |
| <input type="checkbox"/> FN - Fango | <input type="checkbox"/> CP - Cipria |
| <input type="checkbox"/> CA - Cacao | <input type="checkbox"/> CN - Canapa |

Le Acque di Cielo

- | | |
|---|---------------------------------------|
| <input type="checkbox"/> OL - Oltremare | <input type="checkbox"/> CO - Corallo |
| <input type="checkbox"/> SM - Smeraldo | <input type="checkbox"/> NI - Ninfea |
| <input type="checkbox"/> AL - Alga | <input type="checkbox"/> AM - Anemone |

FINITURE LAVABO

WASHBASIN FINISHES

Essential Colors

- Bianco/white - glossy
- N - Nero/black - glossy
- FU - Fumo - glossy
- TP - Talpa - glossy

Le Terre di Cielo

- | | |
|---------------------------------------|--|
| <input type="checkbox"/> TL - Talco | <input type="checkbox"/> AN - Arenaria |
| <input type="checkbox"/> PM - Pomice | <input type="checkbox"/> AV - Avena |
| <input type="checkbox"/> BR - Brina | <input type="checkbox"/> LN - Lino |
| <input type="checkbox"/> BA - Basalto | <input type="checkbox"/> AG - Agave |
| <input type="checkbox"/> LV - Lavagna | <input type="checkbox"/> MU - Muschio |
| <input type="checkbox"/> CM - Cemento | <input type="checkbox"/> PL - Polvere |
| <input type="checkbox"/> FN - Fango | <input type="checkbox"/> CP - Cipria |
| <input type="checkbox"/> CA - Cacao | <input type="checkbox"/> CN - Canapa |

Le Acque di Cielo

- | | |
|---|---------------------------------------|
| <input type="checkbox"/> OL - Oltremare | <input type="checkbox"/> CO - Corallo |
| <input type="checkbox"/> SM - Smeraldo | <input type="checkbox"/> NI - Ninfea |
| <input type="checkbox"/> AL - Alga | <input type="checkbox"/> AM - Anemone |

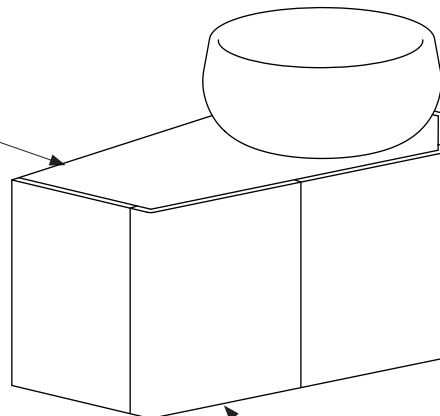

art. **KAM87L/KAM87E**

FINITURE MOBILE IN LEGNO

WOODEN CABINET FINISHES

laccature/laquerings

- | | | |
|--|---------------------------------------|-------------------------------------|
| <input type="checkbox"/> TL - Talco | <input type="checkbox"/> AV - Avena | <input type="checkbox"/> FU - Fumo |
| <input type="checkbox"/> PM - Pomice | <input type="checkbox"/> CM - Cemento | <input type="checkbox"/> TP - Talpa |
| <input type="checkbox"/> BR - Brina | <input type="checkbox"/> BA - Basalto | |
| <input type="checkbox"/> AN - Arenaria | <input type="checkbox"/> MU - Muschio | |
| <input type="checkbox"/> AG - Agave | | |

essenze legno/wood essences

- | |
|---|
| <input type="checkbox"/> RO - Rovere Nero |
| <input type="checkbox"/> RT - Rovere Tinto noce |
| <input type="checkbox"/> RS - Rovere Sbiancato |
| <input type="checkbox"/> RN - Rovere Naturale |
| <input type="checkbox"/> EU - Eucalipto |

Le Acque di Cielo

- | | |
|---|---------------------------------------|
| <input type="checkbox"/> OL - Oltremare | <input type="checkbox"/> CO - Corallo |
| <input type="checkbox"/> SM - Smeraldo | <input type="checkbox"/> NI - Ninfea |
| <input type="checkbox"/> AL - Alga | <input type="checkbox"/> AM - Anemone |

DATA

DATE _____

ATTENZIONE:

La rappresentazione delle finiture è puramente indicativa. Verificare le finiture con le relative cartelle.

Ogni oggetto possiede la peculiarità di essere elaborato secondo principi puramente tradizionali, in modo da garantirne l'assoluta originalità ed unicità. Le eventuali piccole variazioni di colore, tono o venature fra gli articoli sono da considerarsi pregi e non difetti, in quanto garanzia della fattura manuale del prodotto, che fa di ogni oggetto Cielo un pezzo unico ed esclusivo, lontano dall'omologazione industriale. In fase d'ordine si intendono, pertanto, accettate tali tolleranze che non possono dare adito a contestazioni di alcun genere.

Verificare sempre le disponibilità e i tempi di consegna con il commerciale.

FIRMA DEL CLIENTE

SIGNATURE _____

ATTENTION:

The representation of the finishes is merely indicative. Please choose the finishes using the folders.

Every item possesses that particular feature of being processed according to purely traditional principles that guarantee its absolute originality and uniqueness. The small variations in colour, hues or streaks on the items are to be considered as qualities and not defects, since they warranty the handcrafted processing which makes each Cielo item a unique and exclusive piece that cannot be compared to industrial standardization. When making the order, the client implicitly accepts those various features that may give rise to claims of any sort.

Always check the availability and delivery time with the commercial department.

modelli disponibili / available models

KANTO collection

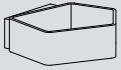

Kanto con mensola
Kanto with shelf



finiture / finishes

LAVABO IN CERAMICA / CERAMIC WASHBASIN AND TOP



KALS
KALSSF

Le Terre di Cielo

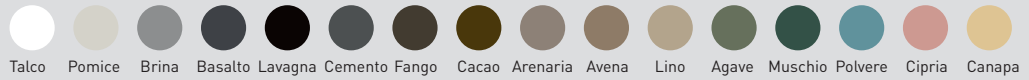

KAML

Le Acque di Cielo



Essential colors

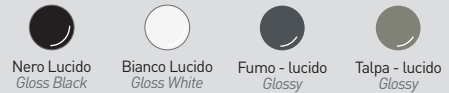

note tecniche lavabo / washbasin technical notes



monoforo
one tap hole



senza foro su richiesta
no tap hole on request



con un lato non smaltato
one side is unglazed



senza troppopieno,
without overflow, overflow on
requeste



installazione sospesa
wall-hung installation



installazione da
appoggio
on top installation

CLIENTE/client: ORD. REF.:

QUANTITA'/quantity: EMAIL:

INDICARE CON UN SEGNO LE FINITURE SCELTE PER I DIVERSI COMPONENTI

INDICATE WITH A TICK, THE CHOSEN FINISHES FOR ALL THE COMPONENTS

art. **KALS/KALSSF**

art. **KAML**

FINITURE LAVABO
TOP FINISHES

Essential Colors

- Bianco/white - glossy
- N - Nero/black - glossy
- FU - Fumo - glossy
- TP - Talpa - glossy

Le Terre di Cielo

<input type="radio"/> TL - Talco	<input type="radio"/> AN - Arenaria
<input type="radio"/> PM - Pomice	<input type="radio"/> AV - Avena
<input type="radio"/> BR - Brina	<input type="radio"/> LN - Lino
<input type="radio"/> BA - Basalto	<input type="radio"/> AG - Agave
<input type="radio"/> LV - Lavagna	<input type="radio"/> MU - Muschio
<input type="radio"/> CM - Cemento	<input type="radio"/> PL - Polvere
<input type="radio"/> FN - Fango	<input type="radio"/> CP - Cipria
<input type="radio"/> CA - Cacao	<input type="radio"/> CN - Canapa

Le Acque di Cielo

<input type="radio"/> OL - Oltremare	<input type="radio"/> CO - Corallo
<input type="radio"/> SM - Smeraldo	<input type="radio"/> NI - Ninfea
<input type="radio"/> AL - Alga	<input type="radio"/> AM - Anemone

FINITURE MENSOLA
SHELF FINISHES

Essential Colors

- Bianco/white - glossy
- N - Nero/black - glossy
- FU - Fumo - glossy
- TP - Talpa - glossy

Le Terre di Cielo

<input type="radio"/> TL - Talco	<input type="radio"/> AN - Arenaria
<input type="radio"/> PM - Pomice	<input type="radio"/> AV - Avena
<input type="radio"/> BR - Brina	<input type="radio"/> LN - Lino
<input type="radio"/> BA - Basalto	<input type="radio"/> AG - Agave
<input type="radio"/> LV - Lavagna	<input type="radio"/> MU - Muschio
<input type="radio"/> CM - Cemento	<input type="radio"/> PL - Polvere
<input type="radio"/> FN - Fango	<input type="radio"/> CP - Cipria
<input type="radio"/> CA - Cacao	<input type="radio"/> CN - Canapa

Le Acque di Cielo

<input type="radio"/> OL - Oltremare	<input type="radio"/> CO - Corallo
<input type="radio"/> SM - Smeraldo	<input type="radio"/> NI - Ninfea
<input type="radio"/> AL - Alga	<input type="radio"/> AM - Anemone



N.B.
Il lavabo è monoforo, su richiesta può essere prodotto senza foro.

N.B.
The washbasin has 1 hole; may be made without holes upon request

DATA
DATE _____

ATTENZIONE:
La rappresentazione delle finiture è puramente indicativa. Verificare le finiture con le relative cartelle.

Ogni oggetto possiede la peculiarità di essere elaborato secondo principi puramente tradizionali, in modo da garantirne l'assoluta originalità ed unicità. Le eventuali piccole variazioni di colore, tono o venature fra gli articoli sono da considerarsi pregi e non difetti, in quanto garanzia della fattura manuale del prodotto, che fa di ogni oggetto Cielo un pezzo unico ed esclusivo, lontano dall'omologazione industriale. In fase d'ordine si intendono, pertanto, accettate tali tolleranze che non possono dare adito a contestazioni di alcun genere.















Verificare sempre le disponibilità e i tempi di consegna con il commerciale.

FIRMA DEL CLIENTE
SIGNATURE _____

ATTENTION:
The representation of the finishes is merely indicative. Please choose the finishes using the folders.

Every item possesses that particular feature of being processed according to purely traditional principles that guarantee its absolute originality and uniqueness. The small variations in colour, hues or streaks on the items are to be considered as qualities and not defects, since they warranty the handcrafted processing which makes each Cielo item a unique and exclusive piece that cannot be compared to industrial standardization. When making the order, the client implicitly accepts those various features that may give rise to claims of any sort.

Always check the availability and delivery time with the commercial department.

	Size (cm)	Product code	Net weight (Kg)	Finishes	Euro	Pz.	Pz.
	Medidas Dimensions Maße Размеры	Artículo Article Artikel Артикул	Peso neto Poids net Reingewicht вес нетто	Acabados Finitions Farbe Отделки	Евро	шт. pallet Italia	шт. pallet Cont.
 <p>Wall-hung Kanto washbasin with one hole Lavabo Kanto suspendido con 1 agujero Lavabo Kanto suspendu monotrou Kanto Aufsatzbecken Hängender 1-Loch Раковина подвесная одно отверстие под смеситель</p>	50 x 52 x h 15	KALS(X)* KALSSF(X)* no tap hole sin agujero sans orifice ohne Loch без отверстия		<ul style="list-style-type: none">  Gloss White  *X = N - Gloss Black  *X = FU - Fumo  *X = TP - Talpa  Le Terre di Cielo  Le Acque di Cielo 	363,00 495,00 495,00 495,00 495,00 495,00		
 <p>Kanto ceramic shelf Estante Kanto en cerámica \ tablette Kanto en céramique \ Konsole Kanto \ Полочк Kanto</p>	50 x 52 x h 3	KAML(X)*		<ul style="list-style-type: none">  Gloss White  *X = N - Gloss Black  *X = FU - Fumo  *X = TP - Talpa  Le Terre di Cielo  Le Acque di Cielo 	319,00 396,00 396,00 396,00 396,00 396,00		
<p>Fixing bracket for Kanto shelf Soporte de fijación para estante Kanto Support de fixation pour tablette Kanto Befestigungselement für Konsole Kanto Крепежный кронштейн для полки Kanto</p>		KAFI(X)*			165,00		
<p>The washbasin is recommended for wall hung installation. For on top installation customers are advised to the require the "RETTIFICA" option. Se recomienda la instalación del lavabo suspendido. Para instalaciones de apoyo se aconseja usar la opción "RETTIFICA". / La vasque est recommandée pour l'installation suspendu. Pour l'installation à poser on conseille l'option "RETTIFICA". / Es empfiehlt sich, das Waschbecken hängend zu installieren. Bei Aufsatzmontage bitte die Option "RETTIFICA" anfragen. / Данная раковина предназначена для подвесной установки. При установке на столешницу рекомендуется запросить опцию "RETTIFICA".</p>		RETTIFICA GRINDING РЕКТИФИКАЦИЯ			10,00		

Technical symbols legend /
Simbolos técnicos clave / Légende
symboles techniques / Technische
Zeichenerklärung / Перечень
технических символов

one tap hole
con 1 agujero
monotrou
1-Loch
одно отверстие
под смеситель

no tap hole on request
sin agujero, solo a petición
sans orifice sur demande
auf Anfrage ohne Loch
без отверстия под
смеситель по запросу

one side is unglazed
con un lado sin esmaltar
avec un côté non émaillé
eine Seite unglasiert
одна сторона не
покрыта эмалью

without overflow, overflow on request
sin rebosadero, con
rebosadero solo a petición / sans trop-
plein, avec trop-plein sur demande /
ohne Überlauf, auf Anfrage mit Überlauf
без слива-перелива, с переливом по
запросу

wall-hung installation
instalación suspendida
installation suspendue
wandhängende Montage
подвесная установка

on top installation
instalación de apoyo
installation à partir du plan
Montage auf Platte
установка на столешницу





































with fixing parts
fijaciones incluidas
fixations incluses
inklusive Befestigungen
в комплекте с крепежами













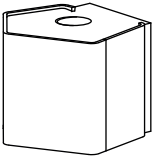

Le Terre di Cielo

-  TL - Talco
-  PM - Pomice
-  BR - Brina
-  BA - Basalto
-  LV - Lavagna
-  CM - Cemento
-  FN - Fango
-  CA - Cacao
-  AN - Arenaria
-  AV - Avena
-  LN - Lino
-  AG - Agave
-  MU - Muschio
-  PL - Polvere
-  CP - Cipria
-  CN - Canapa

Le Acque di Cielo

-  OL - Oltremare
-  SM - Smeraldo
-  AL - Alga
-  CO - Corallo
-  NI - Ninfea
-  AM - Anemone

	Product code Artículo Article Artikel Артикул	Net weight (Kg) Peso neto Poids net Reingewicht вес нетто	Finishes Acabados Finitions Farbe Отделки	Euro Евро
	Universal click/clack drain in CHROME with ceramic lid Válvula universal click/clack Cromado con tapa en cerámica Bonde universelle clic/clac Chromé avec clapet en céramique Universal-Ablaufgarnitur Click-Clack Chrom mit Keramikstopfen Универсальный донный клапан click/clack хром с керамической крышкой	PIL01(X)* 0,40	<ul style="list-style-type: none">  Gloss White  *X = N - Gloss Black  *X = FU - Fumo  *X = TP- Talpa  Le Terre di Cielo  Le Acque di Cielo 	<ul style="list-style-type: none"> 95,00 114,00 139,00 139,00 139,00 139,00
	Universal click/clack drain in BLACK MATT finish with ceramic lid Válvula universal click/clack Negro Matt con tapa en cerámica Bonde universelle clic/clac Noir Mat avec clapet en céramique / Universal-Ablaufgarnitur Click-Clack Matt Schwarz mit Keramikstopfen / Универсальный донный клапан click/clack черный матовый с керамической крышкой	PIL01NM(X)* 0,40	<ul style="list-style-type: none">  Gloss White  *X = N - Gloss Black  *X = FU - Fumo  *X = TP- Talpa  Le Terre di Cielo  Le Acque di Cielo 	<ul style="list-style-type: none"> 120,00 159,00 169,00 169,00 169,00 169,00
	Universal click/clack drain in CEMENTO finish with ceramic lid Válvula universal click/clack Cemento con tapa en cerámica Bonde universelle clic/clac Cemento avec clapet en céramique Universal-Ablaufgarnitur Click-Clack Cement mit Keramikstopfen Универсальный донный Cemento click/clack с керамической крышкой	PIL01CM(X)* 0,40	<ul style="list-style-type: none">  Gloss White  *X = N - Gloss Black  *X = FU - Fumo  *X = TP- Talpa  Le Terre di Cielo  Le Acque di Cielo 	<ul style="list-style-type: none"> 120,00 159,00 169,00 169,00 169,00 169,00
	Universal click/clack drain in BRONZE with ceramic lid Válvula universal click/clack Bronze con tapa en cerámica Bonde universelle clic/clac Bronze avec clapet en céramique Universal-Ablaufgarnitur Click-Clack Bronze mit Keramikstopfen Универсальный донный клапан click/clack бронза с керамической крышкой	PIL01BR(X)* 0,40	<ul style="list-style-type: none">  Gloss White  *X = N - Gloss Black  *X = FU - Fumo  *X = TP- Talpa  Le Terre di Cielo  Le Acque di Cielo 	<ul style="list-style-type: none"> 135,00 171,00 182,00 182,00 182,00 182,00
	CHROMED siphon Sifone Cromado \ Siphon Chromé \ Siphon Verchromt \ сифон Chrome	SISP 0,93	 Chrome	133,00
	MATT BLACK siphon Sifone Negro Mate \ Siphon Noir Mat \ Siphon Schwarz Matt \ Сифон Черный матовый	SIFN 0,93	 Matt Black	194,00
	CEMENTO siphon Sifone Cemento \ Siphon Cemento \ Siphon Cemento \ сифон Cemento	SIFCM 0,93	 Cemento	194,00
	BRONZE siphon Sifone Bronze \ Siphon Bronze \ Siphon Bronze \бронза сифон	SIFBR 0,93	 Bronze	220,00

	Size (cm) Medidas Dimensions Maße Размеры	Product code Artículo Article Artikel Артикул	Net weight (Kg) Peso neto Poids net Reingewicht вес нетто	Finishes Acabados Finitions Farbe Отделки	Euro Евро	Pz. шт. pallet Italia	Pz. шт. pallet Cont.
 <p>Wall-hung Kanto washbasin with one hole Lavabo Kanto suspendido con 1 agujero Lavabo Kanto suspendu monotrou Kanto Aufsatzbecken Hängender 1-Loch Раковина подвесная одно отверстие под смеситель</p>	50 x 52 x h 15	KALS(X)* KALSSF(X)* no tap hole sin agujero sans orifice ohne Loch без отверстия		<ul style="list-style-type: none">  Gloss White  *X = N - Gloss Black  *X = FU - Fumo  *X = TP - Talpa  Le Terre di Cielo  Le Acque di Cielo 	363,00 495,00 495,00 495,00 495,00 495,00		
 <p>Kanto 50 lacquered cabinet Mueble lacad \ Meuble suspendu \ lackierter Möbel \ мебель крашенные</p>	50 x 52 x 40 h	KAM50L(X)*		<ul style="list-style-type: none">  Le Terre di Cielo*  Le Acque di Cielo  FU - Fumo  TP - Talpa 	2310,00 2640,00 2640,00 2640,00		
 <p>Kanto 50 wooden cabinet Mueble de madera \ Meuble en bois \ Holzmöbel \ деревянная мебель</p>		KAM50E(X)*		<ul style="list-style-type: none">  EsSENze Rovere •  *X = EU - Eucalipto 	2695,00 2860,00		

Mandatory composition: washbasin + cabinet
Composición obligatoria: lavabo + mueble
Composition obligatoire: vasque + meuble
Das Möbel besteht obligatorisch aus: Waschbecke + Möbel
Обязательный комплект: раковина + мебель

Le Terre di Cielo  TL - Talco  PM - Pomice  BR - Brina  BA - Basalto  LV - Lavagna  CM - Cemento  FN - Fango  CA - Cacao

 AN - Arenaria  AV - Avena  LN - Lino  AG - Agave  MU - Muschio  PL - Polvere  CP - Cipria  CN - Canapa

Le Acque di Cielo  OL - Oltremare  SM - Smeraldo  AL - Alga  CO - Corallo  NI - Ninfea  AM - Anemone



• **EsSENze Rovere**  RS - Rovere Sbiancato  RN - Rovere Naturale  RN - Rovere Nero  RT - Rovere Tinto Noce





































* **Terre/Acque di Cielo laquering available for cabinet**

*l lacados Terre/Acque di Cielo disponibles para mueble |
laquages Terre/Acque di Cielo disponibles pour le meuble |
Für Möbel erhältliche Lackierungen Terre/Acque di Cielo |
крашенная отделка Terre/Acque di Cielo доступна для
ящика и столешницы*

 TL - Talco  PM - Pomice  BR - Brina  AN - Arenaria  AV - Avena

 CM - Cemento  BA - Basalto  MU - Muschio  AG - Agave

 OL - Oltremare  SM - Smeraldo  AL - Alga  CO - Corallo  NI - Ninfea  AM - Anemone

	Product code Artículo Article Artikel Артикул	Net weight (Kg) Peso neto Poids net Reingewicht вес нетто	Finishes Acabados Finitions Farbe Отделки	Euro Евро
 Universal click/clack drain in CHROME with ceramic lid Válvula universal click/clack Cromado con tapa en cerámica Bonde universelle clic/clac Chromé avec clapet en céramique Universal-Ablaufgarnitur Click-Clack Chrom mit Keramikstopfen Универсальный донный клапан click/clack хром с керамической крышкой	PIL01(X)*	0,40	<ul style="list-style-type: none">  Gloss White  *X = N - Gloss Black  *X = FU - Fumo  *X = TP- Talpa  Le Terre di Cielo  Le Acque di Cielo 	<p>95,00</p> <p>114,00</p> <p>139,00</p> <p>139,00</p> <p>139,00</p> <p>139,00</p>
 Universal click/clack drain in BLACK MATT finish with ceramic lid Válvula universal click/clack Negro Matt con tapa en cerámica Bonde universelle clic/clac Noir Mat avec clapet en céramique / Universal-Ablaufgarnitur Click-Clack Matt Schwarz mit Keramikstopfen / Универсальный донный клапан click/clack черный матовый с керамической крышкой	PIL01NM(X)*	0,40	<ul style="list-style-type: none">  Gloss White  *X = N - Gloss Black  *X = FU - Fumo  *X = TP- Talpa  Le Terre di Cielo  Le Acque di Cielo 	<p>120,00</p> <p>159,00</p> <p>169,00</p> <p>169,00</p> <p>169,00</p> <p>169,00</p>
 Universal click/clack drain in CEMENTO finish with ceramic lid Válvula universal click/clack Cemento con tapa en cerámica Bonde universelle clic/clac Cemento avec clapet en céramique Universal-Ablaufgarnitur Click-Clack Cement mit Keramikstopfen Универсальный донный Cemento click/clack с керамической крышкой	PIL01CM(X)*	0,40	<ul style="list-style-type: none">  Gloss White  *X = N - Gloss Black  *X = FU - Fumo  *X = TP- Talpa  Le Terre di Cielo  Le Acque di Cielo 	<p>120,00</p> <p>159,00</p> <p>169,00</p> <p>169,00</p> <p>169,00</p> <p>169,00</p>
 Universal click/clack drain in BRONZE with ceramic lid Válvula universal click/clack Bronce con tapa en cerámica Bonde universelle clic/clac Bronze avec clapet en céramique Universal-Ablaufgarnitur Click-Clack Bronze mit Keramikstopfen Универсальный донный клапан click/clack бронза с керамической крышкой	PIL01BR(X)*	0,40	<ul style="list-style-type: none">  Gloss White  *X = N - Gloss Black  *X = FU - Fumo  *X = TP- Talpa  Le Terre di Cielo  Le Acque di Cielo 	<p>135,00</p> <p>171,00</p> <p>182,00</p> <p>182,00</p> <p>182,00</p> <p>182,00</p>
 CHROMED siphon Sifone Cromado \ Siphon Chromé \ Siphon Verchromt \ сифон Chrome	SISP	0,93	 Chrome	133,00
 MATT BLACK siphon Sifone Negro Mate \ Siphon Noir Mat \ Siphon Schwarz Matt \ Сифон Черный матовый	SIFN	0,93	 Matt Black	194,00
 CEMENTO siphon Sifone Cemento \ Siphon Cemento \ Siphon Cemento \ сифон Cemento	SIFCM	0,93	 Cemento	194,00
 BRONZE siphon Sifone Bronce \ Siphon Bronze \ Siphon Bronze \ бронза сифон	SIFBR	0,93	 Bronze	220,00

Technical symbols legend /
Símbolos técnicos clave / Légende
symboles techniques / Technische
Zeichenerklärung / Перечень
технических символов

 **one tap hole**
con 1 agujero
monotrou
1-Loch
одно отверстие
под смеситель

 **no tap hole on request**
sin agujero, solo a petición
sans orifice sur demande
auf Anfrage ohne Loch
без отверстия под
смеситель по запросу



































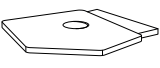



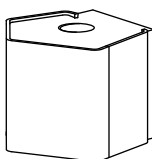

 **one side is unglazed**
con un lado sin esmaltar
avec un côté non émaillé
eine Seite unglasiert
одна сторона не
покрыта эмалью

 **without overflow, overflow on request**
sin rebosadero, con rebosadero solo a petición / sans trop-plein, avec trop-plein sur demande / ohne Überlauf, auf Anfrage mit Überlauf
без слива-перелива, с переливом по запросу

 **wall-hung installation**
instalación suspendida
installation suspendue
wandhängende Montage
подвесная установка

 **on top installation**
instalación de apoyo
installation à partir du plan
Montage auf Platte
установка на столешницу

 **with fixing parts**
fijaciones incluidas
fixations incluses
inklusive Befestigungen
в комплекте с крепежами

	Size (cm) Medidas Dimensions Maße Размеры	Product code Artículo Article Artikel Артикул	Net weight(Kg) Peso neto Poids net Reingewicht вес нетто	Finishes Acabados Finitions Farbe Отделки	Euro Евро	Pz. шт. pallet Italia	Pz. шт. pallet Cont.
 <p>On top bowl h19 Tino Cubela de apoyo h19 Tino \ Vasque à poser h19 Tino Aufsatzbecken h19 Tino \ Накладная чаша h19 Tino</p> 	ø43 x 19 h	BATO(X)*	10,30	<ul style="list-style-type: none">  Gloss White  *X = N - Gloss Black  *X = FU - Fumo  *X = TP- Talpa  Le Terre di Cielo  Le Acque di Cielo 	427,00 697,00 697,00 697,00 697,00 697,00	26	52
 <p>Era Small on top bowl Cubela de apoyo Era Small / Vasque à poser Era Small / Aufsatzbecken Runde Era Small / Раковина круглый Era Small</p> 	ø40 x 15 h	BAERA40(X)*	8,00	<ul style="list-style-type: none">  Gloss White  *X = N - Gloss Black  *X = FU - Fumo  *X = TP- Talpa  Le Terre di Cielo  Le Acque di Cielo 	424,00 690,00 690,00 690,00 690,00 690,00	26	52
 <p>On top bowl without overflow ø40 Cubela de apoyo sin demasiado lleno ø40 Vasque à poser sans trop plein ø40 / Aufsatzbecken ohne Überlauf ø40 / Накладная чаша без переливом ø40</p> 	ø40 x 18,5 h	SHBA40(X)*	8,55	<ul style="list-style-type: none">  Gloss White  *X = N - Gloss Black  *X = FU - Fumo  *X = TP- Talpa  Le Terre di Cielo  Le Acque di Cielo 	427,00 521,00 708,00 708,00 708,00 708,00	26	52
 <p>Ceramic countertop 50 \ Top en cerámica \ Plan en céramique \ Platte \ столешница</p> 	40 x 50 x 1,6 h	KAPI50(X)*		<ul style="list-style-type: none">  Gloss White  *X = N - Gloss Black  *X = FU - Fumo  *X = TP - Talpa  Le Terre di Cielo  Le Acque di Cielo 	275,00 374,00 374,00 374,00 374,00 374,00		
 <p>Kanto 50 lacquered cabinet Mueble lacad \ Meuble suspendu \ lackierter Möbel \ мебель крашенные</p>	50 x 52 x 40 h	KAM50L(X)*		<ul style="list-style-type: none">  Le Terre di Cielo*  Le Acque di Cielo  FU - Fumo  TP - Talpa 	2310,00 2640,00 2640,00 2640,00		
 <p>Kanto 50 wooden cabinet Mueble de madera \ Meuble en bois \ Holzmöbel \ деревянная мебель</p>		KAM50E(X)*		<ul style="list-style-type: none">  EsSENze ROvere •  *X = EU - Eucalipto 	2695,00 2860,00		







Mandatory composition: bowl to choose Tino, Era40, Shui40 + top 50 + cabinet

Composición obligatoria: lavabo sobre encimera para elegir Tino, Era40, Shui40 + top 50 + mueble

Composition obligatoire: vasque à poser au choix Tino, Era40, Shui40 + plan 50 + meuble





Das Möbel besteht obligatorisch aus: Waschbecke Tino, Era40, Shui40 + platte 50 + Möbel

Обязательный комплект: раковина Tino, Era40, Shui40 + столешница 50 + мебель

Le Terre di Cielo  TL - Talco  PM - Pomice  BR - Brina  BA - Basalto  LV - Lavagna  CM - Cemento  FN - Fango  CA - Cacao

 AN - Arenaria  AV - Avena  LN - Lino  AG - Agave  MU - Muschio  PL - Polvere  CP - Cipria  CN - Canapa

Le Acque di Cielo  OL - Oltremare  SM - Smeraldo  AL - Alga  CO - Corallo  NI - Ninfea  AM - Anemone

• EsSENze ROvere  RS - Rovere Sbiancato  RN - Rovere Naturale  RN - Rovere Nero  RT - Rovere Tinto Noce

* Terre/Acque di Cielo laquering available for cabinet

/ lacados Terre/Acque di Cielo disponibles para mueble /

laquages Terre/Acque di Cielo disponibles pour le meuble /

Für Möbel erhältliche Lackierungen Terre/Acque di Cielo /





































крашенная отделка Terre/Acque di Cielo доступна для

ящика и столешницы

 TL - Talco  PM - Pomice  BR - Brina  AN - Arenaria  AV - Avena

 CM - Cemento  BA - Basalto  MU - Muschio  AG - Agave

 OL - Oltremare  SM - Smeraldo  AL - Alga  CO - Corallo  NI - Ninfea  AM - Anemone

	Product code Artículo Article Artikel Артикул	Net weight (Kg) Peso neto Poids net Reingewicht вес нетто	Finishes Acabados Finitions Farbe Отделки	Euro Евро
 <p>Universal click/clack drain in CHROME with ceramic lid Válvula universal click/clack Cromado con tapa en cerámica Bonde universelle clic/clac Chromé avec clapet en céramique Universal-Ablaufgarnitur Click-Clack Chrom mit Keramikstopfen Универсальный донный клапан click/clack хром с керамической крышкой</p>	PIL01(X)*	0,40	<ul style="list-style-type: none">  Gloss White  *X = N - Gloss Black  *X = FU - Fumo  *X = TP- Talpa  Le Terre di Cielo  Le Acque di Cielo 	<p>95,00</p> <p>114,00</p> <p>139,00</p> <p>139,00</p> <p>139,00</p> <p>139,00</p>
 <p>Universal click/clack drain in BLACK MATT finish with ceramic lid / Válvula universal click/clack Negro Matt con tapa en cerámica Bonde universelle clic/clac Noir Mat avec clapet en céramique / Universal-Ablaufgarnitur Click-Clack Matt Schwarz mit Keramikstopfen / Универсальный донный клапан click/clack черный матовый с керамической крышкой</p>	PIL01NM(X)*	0,40	<ul style="list-style-type: none">  Gloss White  *X = N - Gloss Black  *X = FU - Fumo  *X = TP- Talpa  Le Terre di Cielo  Le Acque di Cielo 	<p>120,00</p> <p>159,00</p> <p>169,00</p> <p>169,00</p> <p>169,00</p> <p>169,00</p>
 <p>Universal click/clack drain in CEMENTO finish with ceramic lid / Válvula universal click/clack Cemento con tapa en cerámica Bonde universelle clic/clac Cemento avec clapet en céramique Universal-Ablaufgarnitur Click-Clack Cement mit Keramikstopfen Универсальный донный Cemento click/clack с керамической крышкой</p>	PIL01CM(X)*	0,40	<ul style="list-style-type: none">  Gloss White  *X = N - Gloss Black  *X = FU - Fumo  *X = TP- Talpa  Le Terre di Cielo  Le Acque di Cielo 	<p>120,00</p> <p>159,00</p> <p>169,00</p> <p>169,00</p> <p>169,00</p> <p>169,00</p>
 <p>Universal click/clack drain in BRONZE with ceramic lid Válvula universal click/clack Bronce con tapa en cerámica Bonde universelle clic/clac Bronze avec clapet en céramique Universal-Ablaufgarnitur Click-Clack Bronze mit Keramikstopfen Универсальный донный клапан click/clack бронза с керамической крышкой</p>	PIL01BR(X)*	0,40	<ul style="list-style-type: none">  Gloss White  *X = N - Gloss Black  *X = FU - Fumo  *X = TP- Talpa  Le Terre di Cielo  Le Acque di Cielo 	<p>135,00</p> <p>171,00</p> <p>182,00</p> <p>182,00</p> <p>182,00</p> <p>182,00</p>
 <p>CHROMED siphon Sifone Cromado \ Siphon Chromé \ Siphon Verchromt \ сифон Chrome</p>	SISP	0,93	 Chrome	133,00
 <p>MATT BLACK siphon Sifone Negro Mate \ Siphon Noir Mat \ Siphon Schwarz Matt \ Сифон Черный матовый</p>	SIFN	0,93	 Matt Black	194,00
 <p>CEMENTO siphon Sifone Cemento \ Siphon Cemento \ Siphon Cemento \ сифон Cemento</p>	SIFCM	0,93	 Cemento	194,00
 <p>BRONZE siphon Sifone Bronce \ Siphon Bronze \ Siphon Bronze \бронза сифон</p>	SIFBR	0,93	 Bronze	220,00

Technical symbols legend /
Simbolos técnicos clave / **Legende**
symboles techniques / **Technische**
Zeichenerklärung / **Перечень**
технических символов

 **one tap hole**
con 1 agujero
monotrou
1-Loch
одно отверстие
под смеситель

 **no tap hole on request**
sin agujero, solo a petición
sans orifice sur demande
auf Anfrage ohne Loch
без отверстия под
смеситель по запросу

 **no tap holes**
sin agujero para
grifo
sans orifice robinet
ohne Hahnloch
без отверстия под
смеситель



 **one side is unglazed**
con un lado sin esmaltado
avec un côté non émaillé
eine Seite unglasiert
одна сторона не
покрыта эмалью

 **all sides are enamelled**
con todos los lados esmaltados
avec tous les côtés émaillés
alle Seiten glasiert
все стороны покрыты эмалью

 **without overflow, overflow on request** / sin rebosadero, con rebosadero solo a petición / sans trop-plein, avec trop-plein sur demande / ohne Überlauf, auf Anfrage mit Überlauf
без слива-перелива, с переливом по запросу

 **wall-hung installation**
instalación suspendida
installation suspendue
wandhängende Montage
подвесная установка

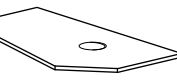
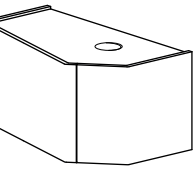
 **on top installation**
instalación de apoyo
installation à partir du plan
Montage auf Platte
установка на столешницу

	Size (cm)	Product code	Net weight(Kg)	Finishes	Euro	Pz.	Pz.
	Medidas Dimensions Maße Размеры	Artículo Article Artikel Артикул	Peso neto Poids net Reingewicht вес нетто	Acabados Finitions Farbe Отделки	Евро	шт. pallet Italia	шт. pallet Cont.
 <p>Wall-hung Kanto washbasin with one hole Lavabo Kanto suspendido con 1 agujero Lavabo Kanto suspendu monotrou Kanto Aufsatzbecken Hängender 1-Loch Раковина подвесная одно отверстие под смеситель</p>	50 x 52 x h 15	KALS(X)* KALSSF(X)* no tap hole sin agujero sans orifice ohne Loch без отверстия		<ul style="list-style-type: none"> Gloss White *X = N - Gloss Black *X = FU - Fumo *X = TP - Talpa Le Terre di Cielo Le Acque di Cielo 	363,00 495,00 495,00 495,00 495,00 495,00		
 <p>Ceramic countertop 87 Top en cerámica / Plan en céramique / Platte / столешница</p>	50 x 83 x h 2	KAPI87(X)*		<ul style="list-style-type: none"> Gloss White *X = N - Gloss Black *X = FU - Fumo *X = TP - Talpa Le Terre di Cielo Le Acque di Cielo 	374,00 506,00 506,00 506,00 506,00 506,00		
 <p>Kanto 87 lacquered cabinet Mueble lacad / Meuble suspendu / lackierter Möbel / мебель крашенные</p>	52 x 87 x 40 h	KAM87L(X)*		<ul style="list-style-type: none"> Le Terre di Cielo* Le Acque di Cielo FU - Fumo TP - Talpa 	2453,00 2783,00 2783,00 2783,00		
 <p>Kanto 87 wooden cabinet Mueble de madera / Meuble en bois / Holzmöbel / деревянная мебель</p>		KAM87E(X)*		<ul style="list-style-type: none"> EsSENze Rovere • *X = EU - Eucalipto 	3179,00 3295,00		

Mandatory composition: washbasin + top 87 + cabinet

Composición obligatoria: lavabo + top 87 + mueble
Composition obligatoire: vasque + plan 87 + meuble
Das Möbel besteht obligatorisch aus: Waschbecke + platte 87 + Möbel
Обязательный комплект: раковина + столешница 87 + мебель

Le Terre di Cielo TL - Talco PM - Pomice BR - Brina BA - Basalto LV - Lavagna CM - Cemento FN - Fango CA - Cacao
 AN - Arenaria AV - Avena LN - Lino AG - Agave MU - Muschio PL - Polvere CP - Cipria CN - Canapa





































Le Acque di Cielo OL - Oltremare SM - Smeraldo AL - Alga CO - Corallo NI - Ninfea AM - Anemone

• **EsSENze Rovere** RS - Rovere Sbiancato RN - Rovere Naturale RN - Rovere Nero RT - Rovere Tinto Noce

* Terre/Acque di Cielo laquering available for cabinet

/ lacados Terre/Acque di Cielo disponibles para mueble /
laquages Terre/Acque di Cielo disponibles pour le meuble /
Für Möbel erhältliche Lackierungen Terre/Acque di Cielo /
крашенная отделка Terre/Acque di Cielo доступна для
ящика и столешницы

TL - Talco PM - Pomice BR - Brina AN - Arenaria AV - Avena
 CM - Cemento BA - Basalto MU - Muschio AG - Agave
 OL - Oltremare SM - Smeraldo AL - Alga CO - Corallo NI - Ninfea AM - Anemone

	Product code Artículo Article Artikel Артикул	Net weight (Kg) Peso neto Poids net Reingewicht вес нетто	Finishes Acabados Finitions Farbe Отделка	Euro Евро
 <p>Universal click/clack drain in CHROME with ceramic lid Válvula universal click/clack Cromado con tapa en cerámica Bonde universelle clic/clac Chromé avec clapet en céramique Universal-Ablaufgarnitur Click-Clack Chrom mit Keramikstopfen Универсальный донный клапан click/clack хром с керамической крышкой</p>	PIL01(X)*	0,40	<ul style="list-style-type: none">  Gloss White  *X = N - Gloss Black  *X = FU - Fumo  *X = TP- Talpa  Le Terre di Cielo  Le Acque di Cielo 	<p>95,00</p> <p>114,00</p> <p>139,00</p> <p>139,00</p> <p>139,00</p> <p>139,00</p>
 <p>Universal click/clack drain in BLACK MATT finish with ceramic lid / Válvula universal click/clack Negro Matt con tapa en cerámica Bonde universelle clic/clac Noir Mat avec clapet en céramique / Universal-Ablaufgarnitur Click-Clack Matt Schwarz mit Keramikstopfen / Универсальный донный клапан click/clack черный матовый с керамической крышкой</p>	PIL01NM(X)*	0,40	<ul style="list-style-type: none">  Gloss White  *X = N - Gloss Black  *X = FU - Fumo  *X = TP- Talpa  Le Terre di Cielo  Le Acque di Cielo 	<p>120,00</p> <p>159,00</p> <p>169,00</p> <p>169,00</p> <p>169,00</p> <p>169,00</p>
 <p>Universal click/clack drain in CEMENTO finish with ceramic lid / Válvula universal click/clack Cemento con tapa en cerámica Bonde universelle clic/clac Cemento avec clapet en céramique Universal-Ablaufgarnitur Click-Clack Cement mit Keramikstopfen Универсальный донный Cemento click/clack с керамической крышкой</p>	PIL01CM(X)*	0,40	<ul style="list-style-type: none">  Gloss White  *X = N - Gloss Black  *X = FU - Fumo  *X = TP- Talpa  Le Terre di Cielo  Le Acque di Cielo 	<p>120,00</p> <p>159,00</p> <p>169,00</p> <p>169,00</p> <p>169,00</p> <p>169,00</p>
 <p>Universal click/clack drain in BRONZE with ceramic lid Válvula universal click/clack Bronce con tapa en cerámica Bonde universelle clic/clac Bronze avec clapet en céramique Universal-Ablaufgarnitur Click-Clack Bronze mit Keramikstopfen Универсальный донный клапан click/clack бронза с керамической крышкой</p>	PIL01BR(X)*	0,40	<ul style="list-style-type: none">  Gloss White  *X = N - Gloss Black  *X = FU - Fumo  *X = TP- Talpa  Le Terre di Cielo  Le Acque di Cielo 	<p>135,00</p> <p>171,00</p> <p>182,00</p> <p>182,00</p> <p>182,00</p> <p>182,00</p>
 <p>CHROMED siphon Sifone Cromado \ Siphon Chromé \ Siphon Verchromt \ сифон Chrome</p>	SISP	0,93	 Chrome	133,00
 <p>MATT BLACK siphon Sifone Negro Mate \ Siphon Noir Mat \ Siphon Schwarz Matt \ Сифон Черный матовый</p>	SIFN	0,93	 Matt Black	194,00
 <p>CEMENTO siphon Sifone Cemento \ Siphon Cemento \ Siphon Cemento \ сифон Cemento</p>	SIFCM	0,93	 Cemento	194,00
 <p>BRONZE siphon Sifone Bronce \ Siphon Bronze \ Siphon Bronze \бронза сифон</p>	SIFBR	0,93	 Bronze	220,00

Technical symbols legend /
Símbolos técnicos clave / Légende
symboles techniques / Technische
Zeichenerklärung / Перечень
технических символов

 **one tap hole**
con 1 agujero
monotrou
1-Loch
одно отверстие
под смеситель

 **no tap hole on request**
sin agujero, solo a petición
sans orifice sur demande
auf Anfrage ohne Loch
без отверстия под
смеситель по запросу







 **one side is unglazed**
con un lado sin esmaltar
avec un côté non émaillé
eine Seite unglasiert
одна сторона не
покрыта эмалью

 **without overflow, overflow on requeste** / sin rebosadero, con rebosadero solo a petición / sans trop-plein, avec trop-plein sur demande / ohne Überlauf, auf Anfrage mit Überlauf / без слива-перелива, с переливом по запросу

 **wall-hung installation**
instalación suspendida
installation suspendue
wandhängende Montage
подвесная установка

 **on top installation**
instalación de apoyo
installation à partir du plan
Montage auf Platte
установка на столешницу

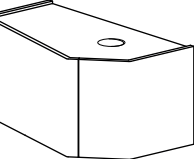
 **with fixing parts**
fijaciones incluidas
fixations incluses
inklusive Befestigungen
в комплекте с крепежами

	Size (cm)	Product code	Net weight(Kg)	Finishes	Euro	Pz.	Pz.
	Medidas Dimensions Maße Размеры	Artículo Article Artikel Артикул	Peso neto Poids net Reingewicht вес нетто	Acabados Finitions Farbe Отделки	Евро	шт. pallet Italia	шт. pallet Cont.
 <p>On top bowl h19 Tino Cubela de apoyo h19 Tino \ Vasque à poser h19 Tino Aufsatzbecken h19 Tino \ Накладная чаша h19 Tino</p>	ø43 x 19 h	BATO(X)*	10,30	<ul style="list-style-type: none"> ○ Gloss White ● *X = N - Gloss Black ● *X = FU - Fumo ● *X = TP- Talpa ● Le Terre di Cielo ● Le Acque di Cielo 	427,00 697,00 697,00 697,00 697,00	26	52
 <p>Era Small on top bowl Cubela de apoyo Era Small / Vasque à poser Era Small / Aufsatzbecken Runde Era Small / Раковина круглый Era Small</p>	ø40 x 15 h	BAERA40(X)*	8,00	<ul style="list-style-type: none"> ○ Gloss White ● *X = N - Gloss Black ● *X = FU - Fumo ● *X = TP- Talpa ● Le Terre di Cielo ● Le Acque di Cielo 	424,00 690,00 690,00 690,00 690,00	26	52
 <p>On top bowl without overflow ø40 Cubela de apoyo sin demasiado lleno ø40 Vasque à poser sans trop plein ø40 / Aufsatzbecken ohne Überlauf ø40 / Накладная чаша без переливом ø40</p>	ø40 x 18,5 h	SHBA40(X)*	8,55	<ul style="list-style-type: none"> ○ Gloss White ● *X = N - Gloss Black ● *X = FU - Fumo ● *X = TP- Talpa ● Le Terre di Cielo ● Le Acque di Cielo 	427,00 521,00 708,00 708,00 708,00	26	52
 <p>Ceramic countertop 87 \ Top en céramica \ Plan en céramique \ Platte \ столешница</p>	50 x 83 x h 2	KAPI87(X)*		<ul style="list-style-type: none"> ○ Gloss White ● *X = N - Gloss Black ● *X = FU - Fumo ● *X = TP - Talpa ● Le Terre di Cielo ● Le Acque di Cielo 	374,00 506,00 506,00 506,00 506,00		
 <p>Kanto 87 lacquered cabinet Mueble lacad \ Meuble suspendu \ lackierter Möbel \ мебель крашенные</p>	52 x 87 x 40 h	KAM87L(X)*		<ul style="list-style-type: none"> ● Le Terre di Cielo* ● Le Acque di Cielo ● FU - Fumo ● TP - Talpa 	2453,00 2783,00 2783,00 2783,00		
 <p>Kanto 87 wooden cabinet Mueble de madera \ Meuble en bois \ Holzmöbel \ деревянная мебель</p>		KAM87E(X)*		<ul style="list-style-type: none"> ● Essenze Rovere * ● *X = EU - Eucalipto 	3179,00 3295,00		

! Mandatory composition: bowl to choose Tino, Era40, Shui40 + top 87 + cabinet
 Composición obligatoria: lavabo sobre encimera para elegir Tino, Era40, Shui40 + top 87 + mueble
 Composition obligatoire: vasque à poser au choix Tino, Era40, Shui40 + plan 87 + meuble
 Das Möbel besteht obligatorisch aus: Waschbecke Tino, Era40, Shui40 + platte 87 + Möbel
 Обязательный комплект: раковина Tino, Era40, Shui40 + столешница 87 + мебель





































Le Terre di Cielo ○ TL - Talco ○ PM - Pomice ○ BR - Brina ○ BA - Basalto ○ LV - Lavagna ○ CM - Cemento ○ FN - Fango ○ CA - Cacao
 ● AN - Arenaria ● AV - Avena ● LN - Lino ● AG - Agave ● MU - Muschio ● PL - Polvere ● CP - Cipria ● CN - Canapa

Le Acque di Cielo ● OL - Oltremare ● SM - Smeraldo ● AL - Alga ● CO - Corallo ● NI - Ninfea ● AM - Anemone

● Essenze Rovere ● RS - Rovere Sbiancato ● RN - Rovere Naturale ● RN - Rovere Nero ● RT - Rovere Tinto Noce

* Terre/Acque di Cielo laquering available for cabinet
 / lacados Terre/Acque di Cielo disponibles para mueble /
 laquages Terre/Acque di Cielo disponibles pour le meuble /
 Für Möbel erhältliche Lackierungen Terre/Acque di Cielo /
 крашенная отделка Terre/Acque di Cielo доступна для
 ящика и столешницы

○ TL - Talco ○ PM - Pomice ○ BR - Brina ● AN - Arenaria ● AV - Avena
 ● CM - Cemento ● BA - Basalto ● MU - Muschio ● AG - Agave
 ● OL - Oltremare ● SM - Smeraldo ● AL - Alga ● CO - Corallo ● NI - Ninfea ● AM - Anemone

	Product code Artículo Article Artikel Артикул	Net weight (Kg) Peso neto Poids net Reingewicht вес нетто	Finishes Acabados Finitions Farbe Отделка	Euro Евро
 <p>Universal click/clack drain in CHROME with ceramic lid Válvula universal click/clack Cromado con tapa en cerámica Bonde universelle clic/clac Chromé avec clapet en céramique Universal-Ablaufgarnitur Click-Clack Chrom mit Keramikstopfen Универсальный донный клапан click/clack хром с керамической крышкой</p>	PIL01(X)*	0,40	<ul style="list-style-type: none">  Gloss White  *X = N - Gloss Black  *X = FU - Fumo  *X = TP- Talpa  Le Terre di Cielo  Le Acque di Cielo 	<p>95,00</p> <p>114,00</p> <p>139,00</p> <p>139,00</p> <p>139,00</p> <p>139,00</p>
 <p>Universal click/clack drain in BLACK MATT finish with ceramic lid / Válvula universal click/clack Negro Matt con tapa en cerámica Bonde universelle clic/clac Noir Mat avec clapet en céramique / Universal-Ablaufgarnitur Click-Clack Matt Schwarz mit Keramikstopfen / Универсальный донный клапан click/clack черный матовый с керамической крышкой</p>	PIL01NM(X)*	0,40	<ul style="list-style-type: none">  Gloss White  *X = N - Gloss Black  *X = FU - Fumo  *X = TP- Talpa  Le Terre di Cielo  Le Acque di Cielo 	<p>120,00</p> <p>159,00</p> <p>169,00</p> <p>169,00</p> <p>169,00</p> <p>169,00</p>
 <p>Universal click/clack drain in CEMENTO finish with ceramic lid / Válvula universal click/clack Cemento con tapa en cerámica Bonde universelle clic/clac Cemento avec clapet en céramique Universal-Ablaufgarnitur Click-Clack Cement mit Keramikstopfen Универсальный донный Cemento click/clack с керамической крышкой</p>	PIL01CM(X)*	0,40	<ul style="list-style-type: none">  Gloss White  *X = N - Gloss Black  *X = FU - Fumo  *X = TP- Talpa  Le Terre di Cielo  Le Acque di Cielo 	<p>120,00</p> <p>159,00</p> <p>169,00</p> <p>169,00</p> <p>169,00</p> <p>169,00</p>
 <p>Universal click/clack drain in BRONZE with ceramic lid Válvula universal click/clack Bronce con tapa en cerámica Bonde universelle clic/clac Bronze avec clapet en céramique Universal-Ablaufgarnitur Click-Clack Bronze mit Keramikstopfen Универсальный донный клапан click/clack бронза с керамической крышкой</p>	PIL01BR(X)*	0,40	<ul style="list-style-type: none">  Gloss White  *X = N - Gloss Black  *X = FU - Fumo  *X = TP- Talpa  Le Terre di Cielo  Le Acque di Cielo 	<p>135,00</p> <p>171,00</p> <p>182,00</p> <p>182,00</p> <p>182,00</p> <p>182,00</p>
 <p>CHROMED siphon Sifone Cromado \ Siphon Chromé \ Siphon Verchromt \ сифон Chrome</p>	SISP	0,93	 Chrome	133,00
 <p>MATT BLACK siphon Sifone Negro Mate \ Siphon Noir Mat \ Siphon Schwarz Matt \ Сифон Черный матовый</p>	SIFN	0,93	 Matt Black	194,00
 <p>CEMENTO siphon Sifone Cemento \ Siphon Cemento \ Siphon Cemento \ сифон Cemento</p>	SIFCM	0,93	 Cemento	194,00
 <p>BRONZE siphon Sifone Bronce \ Siphon Bronze \ Siphon Bronze \ бронза сифон</p>	SIFBR	0,93	 Bronze	220,00

Technical symbols legend /
Símbolos técnicos clave / Légende
symboles techniques / Technische
Zeichenerklärung / Перечень
технических символов

 **one tap hole**
con 1 agujero
monotrou
1-Loch
одно отверстие
под смеситель

 **no tap hole on request**
sin agujero, solo a petición
sans orifice sur demande
auf Anfrage ohne Loch
без отверстия под
смеситель по запросу

 **one side is unglazed**
con un lado sin esmaltar
avec un côté non émaillé
eine Seite unglasiert
одна сторона не
покрыта эмалью

 **without overflow, overflow on requeste** / sin rebosadero, con rebosadero solo a petición / sans trop-plein, avec trop-plein sur demande / ohne Überlauf, auf Anfrage mit Überlauf / без слива-перелива, с переливом по запросу

 **wall-hung installation**
instalación suspendida
installation suspendue
wandhängende Montage
подвесная установка

 **on top installation**
instalación de apoyo
installation à partir du plan
Montage auf Platte
установка на столешницу

 **with fixing parts**
fijaciones incluidas
fixations incluses
inklusive Befestigungen
в комплекте с крепежами

Kanto

mirrors | miroirs | Spiegel | зеркала

cielo

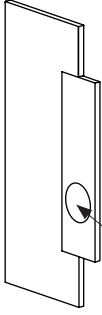
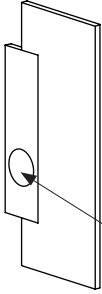
	Size (cm) Medidas Dimensions Maße Размеры	Product code Artículo Article Artikel Артикул	Net weight (Kg) Peso neto Poids net Reingewicht вес нетто	Finishes Acabados Finitions Farbe Отделки	Euro Евро	Pz. шт. pallet Italia	Pz. шт. pallet Cont.
 <p>Kanto mirror right Espejo Kanto derecha / Miroir Kanto droit / Spiegel Kanto Rechts / зеркало Kanto верно</p> <p>magnifying mirror espejo de aumento / miroir grossissant / Vergrößerungsspiegel / увеличительное зеркало</p>	55 x 3 x 110 h	KASPD ^X		● *X = NM - Matt Black ● *X = CM - Cemento	1419,00 1419,00		
 <p>Kanto mirror left Espejo Kanto izquierda / Miroir Kanto gauche / Spiegel Kanto links / зеркало Kanto левый</p> <p>magnifying mirror espejo de aumento / miroir grossissant / Vergrößerungsspiegel / увеличительное зеркало</p>	55 x 3 x 110 h	KASPS ^X		● *X = NM - Matt Black ● *X = CM - Cemento	1419,00 1419,00		



Delfo piano in ceramica

Delfo ceramic top

design Giuseppe Pezzano e Andrea Parisio

indice collezione \ collection index pg. 117 - 119

modulo d'ordine \ order form pg. 120 - 127

listino prezzi \ price list pg. 128 - 144

Delfo ceramic top - finishes

Washbasins and shelf finishes

Acabados de Lavabos y top \ Finitions des Lavabos et plan \ Waschbecken - Platte Farbe \ столешница - Отделка Раковина

Essential Colors

-  Gloss White
-  Gloss Black
-  FU - Fumo **NEW**
-  TP - Talpa **NEW**

Le Terre di Cielo



-  TL - Talco
-  PM - Pomice
-  BR - Brina
-  CM - Cemento
-  BA - Basalto
-  LV - Lavagna
-  FN - Fango
-  CA - Cacao
-  AN - Arenaria
-  AV - Avena
-  MU - Muschio
-  AG - Agave
-  LN - Lino
-  CN - Canapa
-  CP - Cipria
-  PL - Polvere

Le Acque di Cielo

-  OL - Oltremare
-  SM - Smeraldo
-  AL - Alga
-  CO - Corallo
-  NI - Ninfea
-  AM - Anemone

Cabinet finishes

Acabados para mueble \ finitions pour le meuble | Für Möbel Farbe | отделка доступна для ящика

-  FU - Fumo **NEW**
-  TP - Talpa **NEW**

Le Terre di Cielo

-  TL - Talco
-  PM - Pomice
-  BR - Brina
-  CM - Cemento
-  BA - Basalto
-  AN - Arenaria
-  AV - Avena
-  MU - Muschio
-  AG - Agave **NEW**

Le Acque di Cielo

-  OL - Oltremare
-  SM - Smeraldo
-  AL - Alga
-  CO - Corallo
-  NI - Ninfea
-  AM - Anemone

Essenze

-  Rovere Sbiancato
-  Rovere Naturale
-  Rovere Tinto Noce **NEW**
-  Rovere Nero
-  Eucalipto

The possible variations of the colour cannot be considered as defect, but as a guarantee of the completely artisan manufacturing of this unique and high quality product. / Las variaciones de colores no se consideran un defecto sino una garantía de una elaboración manual y artesanal en un producto único y de calidad. / Les éventuelles variations de couleur ne peuvent être considérées comme des défauts, elles témoignent en revanche d'une méthode de travail totalement manuelle et artisanale employée pour obtenir un produit fini unique et de qualité. / Eventuelle Farbvariationen sind nicht als Mangel anzusehen, sondern als Garantie für die komplett handwerkliche Anfertigung eines einzigartigen und hochqualitativen Produkts. / Возможные вариации цвета не могут считаться дефектом, а являются подтверждением ручной работы, гарантией качества и уникальности изделия.

Lavabo con mobile / washbasin with cabinet

DELFO 76

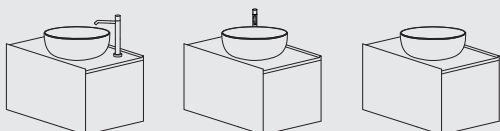

LAVABO + TOP RETTANGOLARE + MOBILE VERSIONE LISCIA 76

Washbasin + rectangular top + smooth version cabinet 76

cm 76 x 50

pag. 128

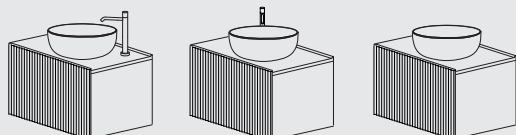

LAVABO + TOP RETTANGOLARE + MOBILE VERSIONE LISTELLI 76

Washbasin + rectangular top + cabinet with front door in solid triangular wooden strips 76

cm 76 x 50

pag. 128

DELFO 113

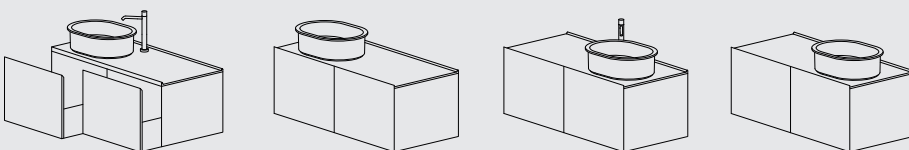

LAVABO + TOP RETTANGOLARE + MOBILE VERSIONE LISCIA 113

Washbasin + rectangular top + smooth version cabinet 113

113 x 50

pag. 130

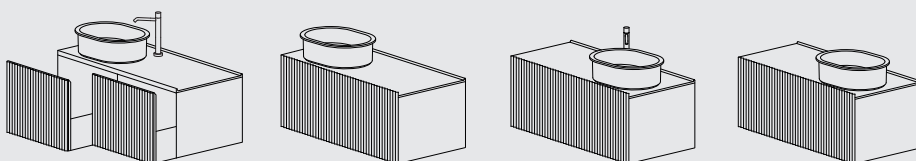

LAVABO + TOP RETTANGOLARE + MOBILE VERSIONE LISTELLI 113

Washbasin + rectangular top + cabinet with front door in solid triangular wooden strips 113

113 x 50

pag. 130

Delfo ceramic top - finishes

Lavabo con mobile / washbasin with cabinet

DELFO 152

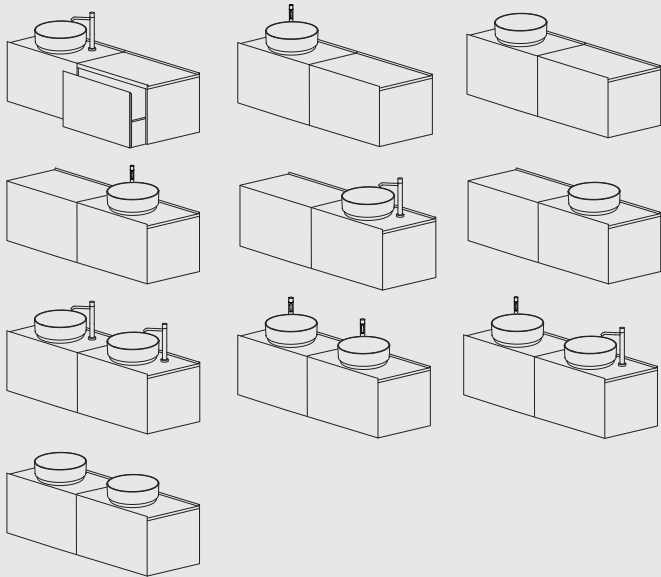

LAVABO + TOP RETTANGOLARE + MOBILE VERSIONE LISCIA 152

Washbasin + rectangular top + smooth version cabinet 152

152 x 50

pag. 132

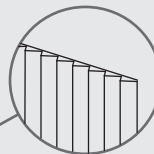
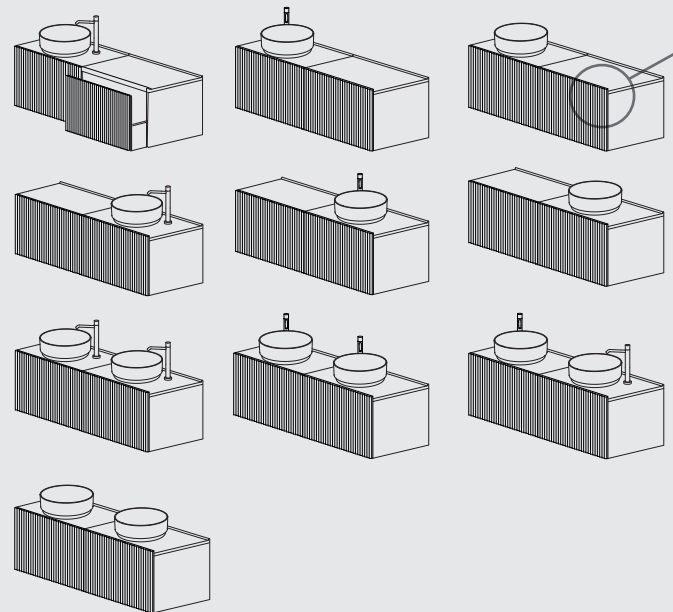

DETTAGLIO DOGHE IN LEGNO
STRIPS WOODEN DETAIL

LAVABO + TOP RETTANGOLARE + MOBILE VERSIONE LISTELLI 152

Washbasin + rectangular top + cabinet with front door in solid triangular

wooden strips 152

152 x 50

pag. 132

The possible variations of the colour cannot be considered as defect, but as a guarantee of the completely artisan manufacturing of this unique and high quality product. / Las variaciones de colores no se consideran un defecto sino una garantía de una elaboración manual y artesanal en un producto único y de calidad. / Les éventuelles variations de couleur ne peuvent être considérées comme des défauts, elles témoignent en revanche d'une méthode de travail totalement manuelle et artisanale employée pour obtenir un produit fini unique et de qualité. / Eventuelle Farbvariationen sind nicht als Mangel anzusehen, sondern als Garantie für die komplett handwerkliche Anfertigung eines einzigartigen und hochqualitativen Produkts. / Возможные вариации цвета не могут считаться дефектом, а являются подтверждением ручной работы, гарантией качества и уникальности изделия.

Lavabo con mobile / washbasin with cabinet

DELFO 226

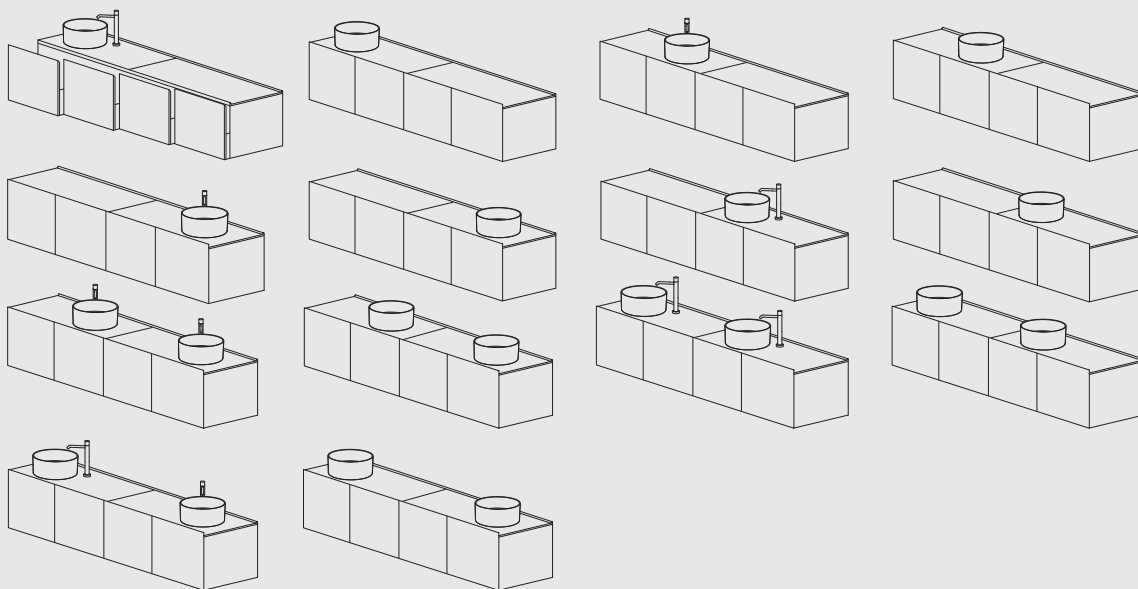

LAVABO + TOP RETTANGOLARE + MOBILE VERSIONE LISCIA 226

Washbasin + rectangular top + smooth version cabinet 226

226 x 50

pag. 136

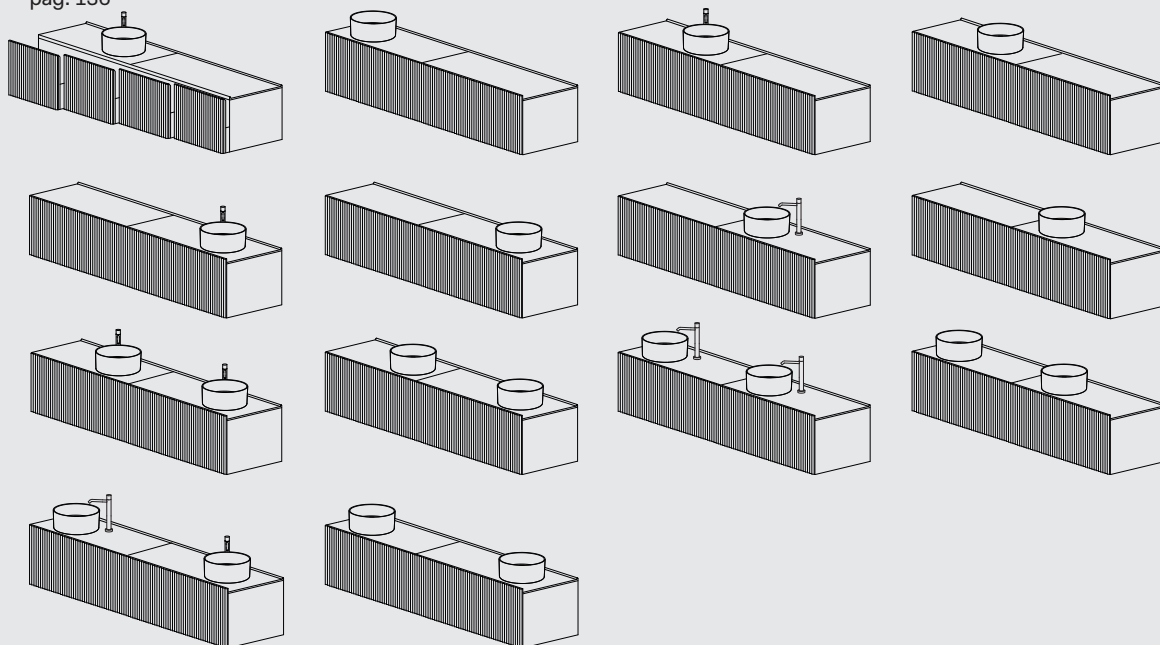

LAVABO + TOP RETTANGOLARE + MOBILE VERSIONE LISTELLI 226

Washbasin + rectangular top + cabinet with front door in solid triangular

wooden strips 226

226 x 50

pag. 136

modelli disponibili / available models

DELFO
collection

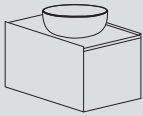

Delfo 76 mobile con ante frontali lisce
Delfo 76 cabinet with smooth front door

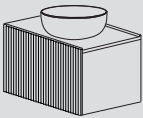

Delfo 76 mobile con ante frontali in listelli di massello triangolari
Delfo 76 cabinet with front door in solid triangular strips



finiture / finishes

LAVABO E TOP RETTANGOLARE IN CERAMICA / CERAMIC WASHBASIN AND RECTANGULAR TOP

Le Terre di Cielo

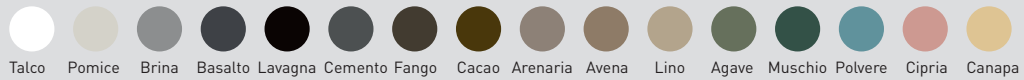

Le Acque di Cielo



Essential colors

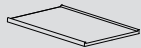

DEPIR76
DEPIR76SF

MOBILE IN LEGNO VERSIONE LISCIA / WOODEN CABINET SMOOTH VERSION

laccature / lacquers

Le Terre di Cielo



essenze / wooden finishes

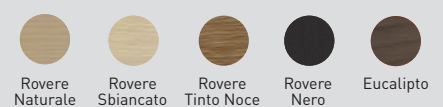

Le Acque di Cielo

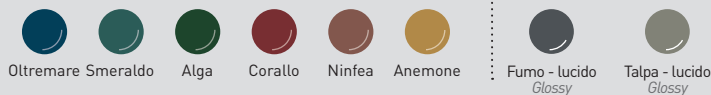

DECR76L
DECR76E



DECR76LSF
DECR76ESF

MOBILE IN LEGNO VERSIONE CON LISTELLI/ WOODEN CABINET WITH LATHS

essenze / wooden finishes

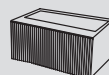
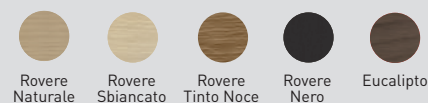

DECRD76E

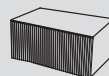

DECRD76ESF

note / notes



composizione obbligatoria: lavabo da appoggio Cielo + top rettangolare + mobile con fori
mandatory combination: on top Cielo washbasin + top + cabinet with holes

Modulo Ordine Delfo 76 piano in ceramica

Order Form Delfo 76 ceramic top

cielo

CLIENTE/client: ORD. REF.:

QUANTITA'/quantity: EMAIL:

INDICARE CON UN SEGNO LE FINITURE SCELTE PER I DIVERSI COMPONENTI

INDICATE WITH A TICK, THE CHOSEN FINISHES FOR ALL THE COMPONENTS

FINITURE LAVABO
TOP FINISHES

Essential Colors

- Bianco/white - glossy
- N - Nero/black - glossy
- FU - Fumo - glossy
- TP - Talpa - glossy

Le Terre di Cielo

<input type="radio"/> TL - Talco	<input type="radio"/> AN - Arenaria
<input type="radio"/> PM - Pomice	<input type="radio"/> AV - Avena
<input type="radio"/> BR - Brina	<input type="radio"/> LN - Lino
<input type="radio"/> BA - Basalto	<input type="radio"/> AG - Agave
<input type="radio"/> LV - Lavagna	<input type="radio"/> MU - Muschio
<input type="radio"/> CM - Cemento	<input type="radio"/> PL - Polvere
<input type="radio"/> FN - Fango	<input type="radio"/> CP - Cipria
<input type="radio"/> CA - Cacao	<input type="radio"/> CN - Canapa

Le Acque di Cielo

<input type="radio"/> OL - Oltremare	<input type="radio"/> CO - Corallo
<input type="radio"/> SM - Smeraldo	<input type="radio"/> NI - Ninfea
<input type="radio"/> AL - Alga	<input type="radio"/> AM - Anemone

art. **DEPIR76** / art. **DEPIR76SF**

FINITURE TOP RETTANGOLARE
RECTANGULAR TOP FINISHES

Essential Colors

- Bianco/white - glossy
- N - Nero/black - glossy
- FU - Fumo - glossy
- TP - Talpa - glossy

Le Terre di Cielo

<input type="radio"/> TL - Talco	<input type="radio"/> AN - Arenaria	<input type="radio"/> OL - Oltremare
<input type="radio"/> PM - Pomice	<input type="radio"/> AV - Avena	<input type="radio"/> SM - Smeraldo
<input type="radio"/> BR - Brina	<input type="radio"/> LN - Lino	<input type="radio"/> AL - Alga
<input type="radio"/> BA - Basalto	<input type="radio"/> AG - Agave	<input type="radio"/> CO - Corallo
<input type="radio"/> LV - Lavagna	<input type="radio"/> MU - Muschio	<input type="radio"/> NI - Ninfea
<input type="radio"/> CM - Cemento	<input type="radio"/> PL - Polvere	<input type="radio"/> AM - Anemone
<input type="radio"/> FN - Fango	<input type="radio"/> CP - Cipria	
<input type="radio"/> CA - Cacao	<input type="radio"/> CN - Canapa	

art. **DECRD76E** / art. **DECRD76ESF**

FINITURE MOBILE IN LEGNO CON ANTA FRONTALE IN LISTELLI
WOODEN CABINET FINISHES WITH FRONT DOOR IN SOLID WOODEN STRIPS

essenze legno/wood essences

- RO - Rovere Nero
- RT - Rovere Tinto Noce
- RS - Rovere Sbiancato
- RN - Rovere Naturale
- EU - Eucalipto

art. **DECR76L** / art. **DECR76LSF**
art. **DECR76E** / art. **DECR76ESF**

FINITURE MOBILE IN LEGNO VERSIONE LISCIA
WOODEN CABINET FINISHES - SMOOTH VERSION

<p>laccature/laquerings</p> <ul style="list-style-type: none"> <input type="radio"/> TL - Talco <input type="radio"/> PM - Pomice <input type="radio"/> BR - Brina <input type="radio"/> AN - Arenaria <input type="radio"/> AV - Avena <input type="radio"/> CM - Cemento <input type="radio"/> BA - Basalto <input type="radio"/> MU - Muschio <input type="radio"/> AG - Agave 	<p>Le Acque di Cielo</p> <ul style="list-style-type: none"> <input type="radio"/> OL - Oltremare <input type="radio"/> SM - Smeraldo <input type="radio"/> AL - Alga <input type="radio"/> CO - Corallo <input type="radio"/> NI - Ninfea <input type="radio"/> AM - Anemone 	<p>essenze legno/wood essences</p> <ul style="list-style-type: none"> <input type="radio"/> RO - Rovere Nero <input type="radio"/> RT - Rovere Tinto Noce <input type="radio"/> RS - Rovere Sbiancato <input type="radio"/> RN - Rovere Naturale <input type="radio"/> EU - Eucalipto
--	--	--

Indicare la bacinella
Indicate the bowl



DATA _____
DATE _____

ATTENZIONE:
La rappresentazione delle finiture è puramente indicativa. Verificare le finiture con le relative cartelle.

Ogni oggetto possiede la peculiarità di essere elaborato secondo principi puramente tradizionali, in modo da garantirne l'assoluta originalità ed unicità. Le eventuali piccole variazioni di colore, tono o venature fra gli articoli sono da considerarsi pregi e non difetti, in quanto garanzia della fattura manuale del prodotto, che fa di ogni oggetto Cielo un pezzo unico ed esclusivo, lontano dall'omologazione industriale. In fase d'ordine si intendono, pertanto, accettate tali tolleranze che non possono dare adito a contestazioni di alcun genere.

Verificare sempre le disponibilità e i tempi di consegna con il commerciale.

FIRMA DEL CLIENTE
SIGNATURE _____

ATTENTION:
The representation of the finishes is merely indicative. Please choose the finishes using the folders.

Every item possesses that particular feature of being processed according to purely traditional principles that guarantee its absolute originality and uniqueness. The small variations in colour, hues or streaks on the items are to be considered as qualities and not defects, since they warranty the handcrafted processing which makes each Cielo item a unique and exclusive piece that cannot be compared to industrial standardization. When making the order, the client implicitly accepts those various features that may give rise to claims of any sort.

Always check the availability and delivery time with the commercial department.



modelli disponibili / available models

DELFO
collection

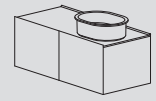
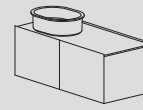

Delfo 113 mobile con ante frontali lisce
Delfo 113 cabinet with smooth front door

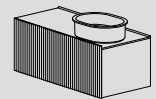
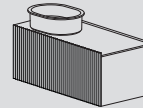

Delfo 113 mobile con ante frontali in listelli di massello triangolari
Delfo 113 cabinet with front door in solid triangular strips

finiture / finishes

LAVABO E TOP RETTANGOLARE IN CERAMICA / CERAMIC WASHBASIN AND RECTANGULAR TOP

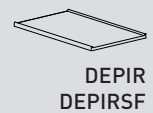
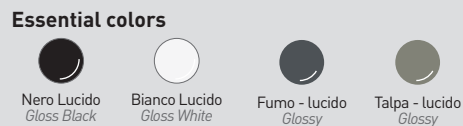
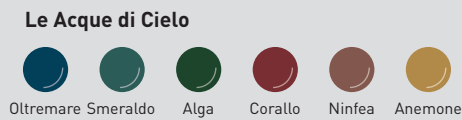

DEPIR
DEPIRSF

MOBILE IN LEGNO VERSIONE LISCIA / WOODEN CABINET SMOOTH VERSION

laccature / lacquers



DECRL
DECRE

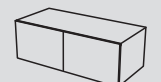

DECRLSF
DECRESF

essenze / wooden finishes

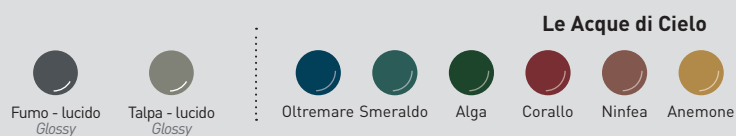
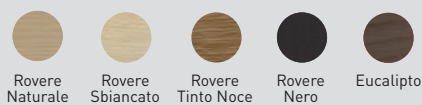

MOBILE IN LEGNO VERSIONE CON LISTELLI/ WOODEN CABINET WITH LATHS

essenze / wooden finishes

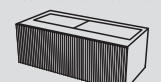
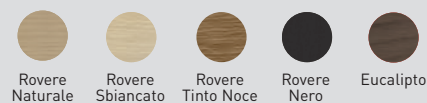

DECRDE



DECRESF

note / notes



composizione obbligatoria: lavabo da appoggio Cielo + top rettangolare + mobile con fori
mandatory combination: on top Cielo washbasin + top + cabinet with holes

Modulo Ordine Delfo 113 piano in ceramica

Order Form Delfo 113 ceramic top

cielo

CLIENTE/client: ORD. REF.:

QUANTITA'/quantity: EMAIL:

INDICARE CON UN SEGNO LE FINITURE SCELTE PER I DIVERSI COMPONENTI

INDICATE WITH A TICK, THE CHOSEN FINISHES FOR ALL THE COMPONENTS

FINITURE LAVABO
TOP FINISHES

Essential Colors

- Bianco/white - glossy
- N - Nero/black - glossy
- FU - Fumo - glossy
- TP - Talpa - glossy

Le Terre di Cielo

<input type="radio"/> TL - Talco	<input type="radio"/> AN - Arenaria
<input type="radio"/> PM - Pomice	<input type="radio"/> AV - Avena
<input type="radio"/> BR - Brina	<input type="radio"/> LN - Lino
<input type="radio"/> BA - Basalto	<input type="radio"/> AG - Agave
<input type="radio"/> LV - Lavagna	<input type="radio"/> MU - Muschio
<input type="radio"/> CM - Cemento	<input type="radio"/> PL - Polvere
<input type="radio"/> FN - Fango	<input type="radio"/> CP - Cipria
<input type="radio"/> CA - Cacao	<input type="radio"/> CN - Canapa

Le Acque di Cielo

<input type="radio"/> OL - Oltremare	<input type="radio"/> CO - Corallo
<input type="radio"/> SM - Smeraldo	<input type="radio"/> NI - Ninfea
<input type="radio"/> AL - Alga	<input type="radio"/> AM - Anemone

art. **DEPIR** / art. **DEPIRSF**

FINITURE TOP RETTANGOLARE
RECTANGULAR TOP FINISHES

Essential Colors

- Bianco/white - glossy
- N - Nero/black - glossy
- FU - Fumo - glossy
- TP - Talpa - glossy

Le Terre di Cielo

<input type="radio"/> TL - Talco	<input type="radio"/> AN - Arenaria
<input type="radio"/> PM - Pomice	<input type="radio"/> AV - Avena
<input type="radio"/> BR - Brina	<input type="radio"/> LN - Lino
<input type="radio"/> BA - Basalto	<input type="radio"/> AG - Agave
<input type="radio"/> LV - Lavagna	<input type="radio"/> MU - Muschio
<input type="radio"/> CM - Cemento	<input type="radio"/> PL - Polvere
<input type="radio"/> FN - Fango	<input type="radio"/> CP - Cipria
<input type="radio"/> CA - Cacao	<input type="radio"/> CN - Canapa

Le Acque di Cielo

<input type="radio"/> OL - Oltremare	<input type="radio"/> SM - Smeraldo	<input type="radio"/> AL - Alga	<input type="radio"/> CO - Corallo
<input type="radio"/> NI - Ninfea	<input type="radio"/> AM - Anemone		

art. **DECRL** / art. **DECRLSF**
art. **DECRE** / art. **DECRLSF**

FINITURE MOBILE IN LEGNO CON ANTA FRONTALE IN LISTELLI
WOODEN CABINET FINISHES WITH FRONT DOOR IN SOLID WOODEN STRIPS

essenze legno/wood essences

- RO - Rovere Nero
- RT - Rovere Tinto Noce
- RS - Rovere Sbiancato
- RN - Rovere Naturale
- EU - Eucalipto

FINITURE MOBILE IN LEGNO VERSIONE LISCIA
WOODEN CABINET FINISHES - SMOOTH VERSION

<p>laccature/laquerings</p> <ul style="list-style-type: none"> <input type="radio"/> TL - Talco <input type="radio"/> PM - Pomice <input type="radio"/> BR - Brina <input type="radio"/> AN - Arenaria <input type="radio"/> AV - Avena <input type="radio"/> CM - Cemento <input type="radio"/> BA - Basalto <input type="radio"/> MU - Muschio <input type="radio"/> AG - Agave 	<p>Le Acque di Cielo</p> <ul style="list-style-type: none"> <input type="radio"/> OL - Oltremare <input type="radio"/> SM - Smeraldo <input type="radio"/> AL - Alga <input type="radio"/> CO - Corallo <input type="radio"/> NI - Ninfea <input type="radio"/> AM - Anemone 	<p>essenze legno/wood essences</p> <ul style="list-style-type: none"> <input type="radio"/> RO - Rovere Nero <input type="radio"/> RT - Rovere Tinto Noce <input type="radio"/> RS - Rovere Sbiancato <input type="radio"/> RN - Rovere Naturale <input type="radio"/> EU - Eucalipto
	<ul style="list-style-type: none"> <input type="radio"/> FU - Fumo - glossy <input type="radio"/> TP - Talpa - glossy 	

Indicare la bacinella

Indicate the bowl



DATA _____
DATE _____

FIRMA DEL CLIENTE _____
SIGNATURE _____

ATTENZIONE:
La rappresentazione delle finiture è puramente indicativa. Verificare le finiture con le relative cartelle.

ATTENTION:
The representation of the finishes is merely indicative. Please choose the finishes using the folders.

Ogni oggetto possiede la peculiarità di essere elaborato secondo principi puramente tradizionali, in modo da garantirne l'assoluta originalità ed unicità. Le eventuali piccole variazioni di colore, tono o venature fra gli articoli sono da considerarsi pregi e non difetti, in quanto garanzia della fattura manuale del prodotto, che fa di ogni oggetto Cielo un pezzo unico ed esclusivo, lontano dall'omologazione industriale. In fase d'ordine si intendono, pertanto, accettate tali tolleranze che non possono dare adito a contestazioni di alcun genere.

Every item possesses that particular feature of being processed according to purely traditional principles that guarantee its absolute originality and uniqueness. The small variations in colour, hues or streaks on the items are to be considered as qualities and not defects, since they warranty the handcrafted processing which makes each Cielo item a unique and exclusive piece that cannot be compared to industrial standardization. When making the order, the client implicitly accepts those various features that may give rise to claims of any sort.

Verificare sempre le disponibilità e i tempi di consegna con il commerciale.

Always check the availability and delivery time with the commercial department.



modelli disponibili / available models

DELFO
collection

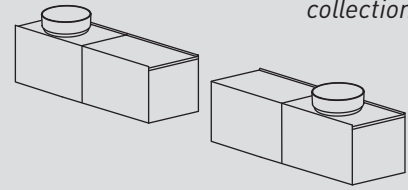

Delfo 152 mobile con ante frontali lisce
Delfo 152 cabinet with smooth front door

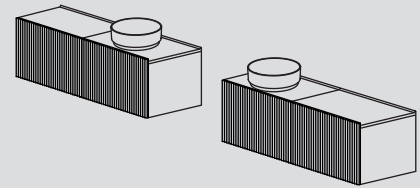

Delfo 152 mobile con ante frontali in listelli di massello triangolari
Delfo 152 cabinet with front door in solid triangular strips

finiture / finishes

LAVABO E TOP RETTANGOLARE IN CERAMICA / CERAMIC WASHBASIN AND RECTANGULAR TOP

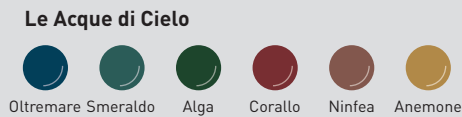

Essential colors

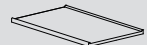
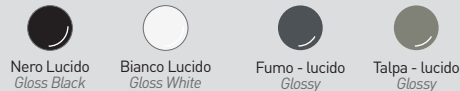

DEPIR76
DEPIR76SF

MOBILE IN LEGNO VERSIONE LISCIA / WOODEN CABINET SMOOTH VERSION

laccature / lacquers

essenze / wooden finishes

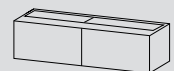
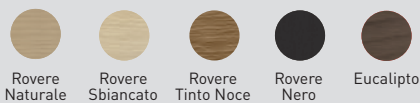

DECR152L
DECR152E



DECR152LSF
DECR152ESF

MOBILE IN LEGNO VERSIONE CON LISTELLI / WOODEN CABINET WITH LATHS

essenze / wooden finishes

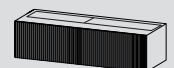
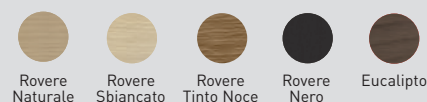

DECRD152E

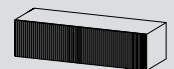

DECRD152ESF

note / notes



composizione obbligatoria: lavabo da appoggio Cielo + top rettangolare + mobile con fori
mandatory combination: on top Cielo washbasin + top + cabinet with holes

Modulo Ordine Delfo 152 piano in ceramica

Order Form Delfo 152 ceramic top

cielo

CLIENTE/client: ORD. REF.:

QUANTITA'/quantity: EMAIL:

INDICARE CON UN SEGNO LE FINITURE SCELTE PER I DIVERSI COMPONENTI

INDICATE WITH A TICK, THE CHOSEN FINISHES FOR ALL THE COMPONENTS

FINITURE LAVABO
TOP FINISHES

Essential Colors

- Bianco/white - glossy
- N - Nero/black - glossy
- FU - Fumo - glossy
- TP - Talpa - glossy

Le Terre di Cielo

<input type="radio"/> TL - Talco	<input type="radio"/> AN - Arenaria
<input type="radio"/> PM - Pomice	<input type="radio"/> AV - Avena
<input type="radio"/> BR - Brina	<input type="radio"/> LN - Lino
<input type="radio"/> BA - Basalto	<input type="radio"/> AG - Agave
<input type="radio"/> LV - Lavagna	<input type="radio"/> MU - Muschio
<input type="radio"/> CM - Cemento	<input type="radio"/> PL - Polvere
<input type="radio"/> FN - Fango	<input type="radio"/> CP - Cipria
<input type="radio"/> CA - Cacao	<input type="radio"/> CN - Canapa

Le Acque di Cielo

<input type="radio"/> OL - Oltremare	<input type="radio"/> CO - Corallo
<input type="radio"/> SM - Smeraldo	<input type="radio"/> NI - Ninfea
<input type="radio"/> AL - Alga	<input type="radio"/> AM - Anemone

art. **DEPIR76** / art. **DEPIR76SF**

FINITURE TOP RETTANGOLARE
RECTANGULAR TOP FINISHES

Essential Colors

- Bianco/white - glossy
- N - Nero/black - glossy
- FU - Fumo - glossy
- TP - Talpa - glossy

Le Terre di Cielo

<input type="radio"/> TL - Talco	<input type="radio"/> AN - Arenaria
<input type="radio"/> PM - Pomice	<input type="radio"/> AV - Avena
<input type="radio"/> BR - Brina	<input type="radio"/> LN - Lino
<input type="radio"/> BA - Basalto	<input type="radio"/> AG - Agave
<input type="radio"/> LV - Lavagna	<input type="radio"/> MU - Muschio
<input type="radio"/> CM - Cemento	<input type="radio"/> PL - Polvere
<input type="radio"/> FN - Fango	<input type="radio"/> CP - Cipria
<input type="radio"/> CA - Cacao	<input type="radio"/> CN - Canapa

Le Acque di Cielo

<input type="radio"/> OL - Oltremare	<input type="radio"/> CO - Corallo
<input type="radio"/> SM - Smeraldo	<input type="radio"/> NI - Ninfea
<input type="radio"/> AL - Alga	<input type="radio"/> AM - Anemone

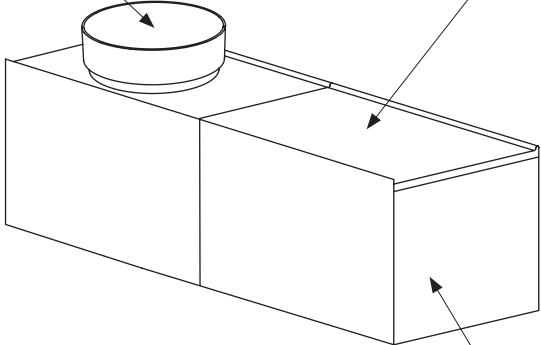

art. **DECRD152E** / art. **DECRD152ESF**

FINITURE MOBILE IN LEGNO CON ANTA FRONTALE IN LISTELLI
WOODEN CABINET FINISHES WITH FRONT DOOR IN SOLID WOODEN STRIPS

essenze legno/wood essences

- RO - Rovere Nero
- RT - Rovere Tinto Noce
- RS - Rovere Sbiancato
- RN - Rovere Naturale
- EU - Eucalipto



art. **DECR152L** / art. **DECR152LSF**
art. **DECR152E** / art. **DECR152ESF**

FINITURE MOBILE IN LEGNO VERSIONE LISCIA
WOODEN CABINET FINISHES - SMOOTH VERSION

<p>laccature/laquerings</p> <ul style="list-style-type: none"> <input type="radio"/> TL - Talco <input type="radio"/> PM - Pomice <input type="radio"/> BR - Brina <input type="radio"/> AN - Arenaria <input type="radio"/> AV - Avena <input type="radio"/> CM - Cemento <input type="radio"/> BA - Basalto <input type="radio"/> MU - Muschio <input type="radio"/> AG - Agave 	<p>Le Acque di Cielo</p> <ul style="list-style-type: none"> <input type="radio"/> OL - Oltremare <input type="radio"/> SM - Smeraldo <input type="radio"/> AL - Alga <input type="radio"/> CO - Corallo <input type="radio"/> NI - Ninfea <input type="radio"/> AM - Anemone <input type="radio"/> FU - Fumo - glossy <input type="radio"/> TP - Talpa - glossy 	<p>essenze legno/wood essences</p> <ul style="list-style-type: none"> <input type="radio"/> RO - Rovere Nero <input type="radio"/> RT - Rovere Tinto Noce <input type="radio"/> RS - Rovere Sbiancato <input type="radio"/> RN - Rovere Naturale <input type="radio"/> EU - Eucalipto
--	---	--

Indicare la bacinella (quantità bacinelle 1 o 2)
Indicate the bowl (quantity of 1 or 2 bowls)

										
CALAT45 ø45 x 16 h	CALA055 55 x 42 x 16 h	BATO ø43 x 19 h	BATA ø45 x 26 h	BAECO 62 x 45 x 18 h	BAECO58 58 x 42 x 16,5 h	THL40 55 x 40 x 16 h	THLAT ø40 x 16 h	BAERA ø45 x 24 h	BAERA40 ø40 x 15 h	SHBA40 ø40 x 18,5 h
1 <input type="checkbox"/> 2 <input type="checkbox"/>	1 <input type="checkbox"/> 2 <input type="checkbox"/>	1 <input type="checkbox"/> 2 <input type="checkbox"/>	1 <input type="checkbox"/> 2 <input type="checkbox"/>	1 <input type="checkbox"/> 2 <input type="checkbox"/>	1 <input type="checkbox"/> 2 <input type="checkbox"/>	1 <input type="checkbox"/> 2 <input type="checkbox"/>	1 <input type="checkbox"/> 2 <input type="checkbox"/>	1 <input type="checkbox"/> 2 <input type="checkbox"/>	1 <input type="checkbox"/> 2 <input type="checkbox"/>	1 <input type="checkbox"/> 2 <input type="checkbox"/>

DATA _____
DATE _____

FIRMA DEL CLIENTE
SIGNATURE _____

ATTENZIONE:
La rappresentazione delle finiture è puramente indicativa. Verificare le finiture con le relative cartelle.

ATTENTION:
The representation of the finishes is merely indicative. Please choose the finishes using the folders.

Ogni oggetto possiede la peculiarità di essere elaborato secondo principi puramente tradizionali, in modo da garantirne l'assoluta originalità ed unicità. Le eventuali piccole variazioni di colore, tono o venature fra gli articoli sono da considerarsi pregi e non difetti, in quanto garanzia della fattura manuale del prodotto, che fa di ogni oggetto Cielo un pezzo unico ed esclusivo, lontano dall'omologazione industriale. In fase d'ordine si intendono, pertanto, accettate tali tolleranze che non possono dare adito a contestazioni di alcun genere.

Every item possesses that particular feature of being processed according to purely traditional principles that guarantee its absolute originality and uniqueness. The small variations in colour, hues or streaks on the items are to be considered as qualities and not defects, since they warranty the handcrafted processing which makes each Cielo item a unique and exclusive piece that cannot be compared to industrial standardization. When making the order, the client implicitly accepts those various features that may give rise to claims of any sort.

Verificare sempre le disponibilità e i tempi di consegna con il commerciale.

Always check the availability and delivery time with the commercial department.

modelli disponibili / available models

DELFO
collection

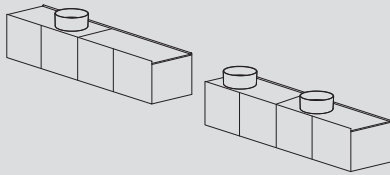

Delfo 226 mobile con ante frontali lisce
Delfo 226 cabinet with smooth front door

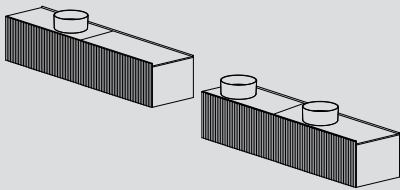

Delfo 226 mobile con ante frontali in listelli di massello triangolari
Delfo 226 cabinet with front door in solid triangular strips



finiture / finishes

LAVABO E TOP RETTANGOLARE IN CERAMICA / CERAMIC WASHBASIN AND RECTANGULAR TOP

Le Terre di Cielo

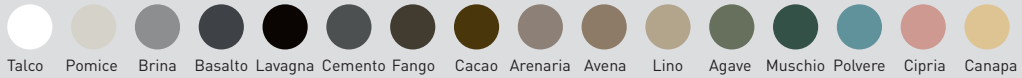

Talco Pomice Brina Basalto Lavagna Cemento Fango Cacao Arenaria Avena Lino Agave Muschio Polvere Cipria Canapa

Le Acque di Cielo



Oltremare Smeraldo Alga Corallo Ninfea Anemone

Essential colors

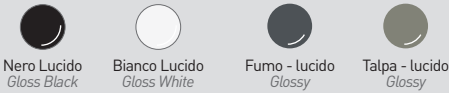

Nero Lucido Gloss Black Bianco Lucido Gloss White Fumo - lucido Glossy Talpa - lucido Glossy

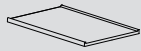

DEPIR
DEPIRSF

MOBILE IN LEGNO VERSIONE LISCIA / WOODEN CABINET SMOOTH VERSION

laccature / lacquers

Le Terre di Cielo



Talco Pomice Brina Arenaria Avena Cemento Basalto Muschio Agave

Le Acque di Cielo



Oltremare Smeraldo Alga Corallo Ninfea Anemone

essenze / wooden finishes

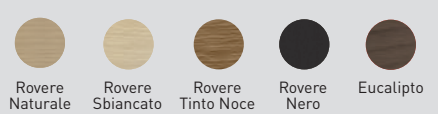

Rovere Naturale Rovere Sbiancato Rovere Tinto Noce Rovere Nero Eucalipto



Fumo - lucido Glossy Talpa - lucido Glossy

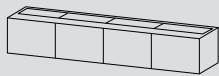

DECR226L
DECR226E

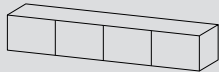

DECR226LSF
DECR226ESF

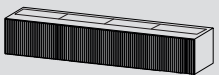

DECR226L
DECR226E

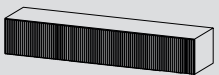

DECR226LSF
DECR226ESF

MOBILE IN LEGNO VERSIONE CON LISTELLI / WOODEN CABINET WITH LATHS

essenze / wooden finishes

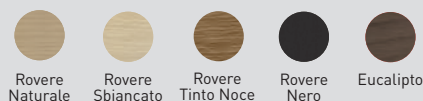

Rovere Naturale Rovere Sbiancato Rovere Tinto Noce Rovere Nero Eucalipto

note / notes



composizione obbligatoria: lavabo da appoggio Cielo + top rettangolare + mobile con fori
mandatory combination: on top Cielo washbasin + top + cabinet with holes

Modulo Ordine Delfo 226 piano in ceramica

Order Form Delfo 226 ceramic top

cielo

CLIENTE/client:

ORD. REF.:

QUANTITA'/quantity:

EMAIL:

INDICARE CON UN SEGNO LE FINITURE SCELTE PER I DIVERSI COMPONENTI

INDICATE WITH A TICK, THE CHOSEN FINISHES FOR ALL THE COMPONENTS

FINITURE LAVABO

TOP FINISHES

Essential Colors

- Bianco/white - glossy
- N - Nero/black - glossy
- FU - Fumo - glossy
- TP - Talpa - glossy

Le Terre di Cielo

<input type="radio"/> TL - Talco	<input type="radio"/> AN - Arenaria
<input type="radio"/> PM - Pomice	<input type="radio"/> AV - Avena
<input type="radio"/> BR - Brina	<input type="radio"/> LN - Lino
<input type="radio"/> BA - Basalto	<input type="radio"/> AG - Agave
<input type="radio"/> LV - Lavagna	<input type="radio"/> MU - Muschio
<input type="radio"/> CM - Cemento	<input type="radio"/> PL - Polvere
<input type="radio"/> FN - Fango	<input type="radio"/> CP - Cipria
<input type="radio"/> CA - Cacao	<input type="radio"/> CN - Canapa

Le Acque di Cielo

<input type="radio"/> OL - Oltremare	<input type="radio"/> CO - Corallo
<input type="radio"/> SM - Smeraldo	<input type="radio"/> NI - Ninfea
<input type="radio"/> AL - Alga	<input type="radio"/> AM - Anemone

art. **DEPIR** / art. **DEPIRSF**

FINITURE TOP RETTANGOLARE

RECTANGULAR TOP FINISHES

Essential Colors

- Bianco/white - glossy
- N - Nero/black - glossy
- FU - Fumo - glossy
- TP - Talpa - glossy

Le Terre di Cielo

<input type="radio"/> TL - Talco	<input type="radio"/> AN - Arenaria
<input type="radio"/> PM - Pomice	<input type="radio"/> AV - Avena
<input type="radio"/> BR - Brina	<input type="radio"/> LN - Lino
<input type="radio"/> BA - Basalto	<input type="radio"/> AG - Agave
<input type="radio"/> LV - Lavagna	<input type="radio"/> MU - Muschio
<input type="radio"/> CM - Cemento	<input type="radio"/> PL - Polvere
<input type="radio"/> FN - Fango	<input type="radio"/> CP - Cipria
<input type="radio"/> CA - Cacao	<input type="radio"/> CN - Canapa

Le Acque di Cielo

<input type="radio"/> OL - Oltremare	<input type="radio"/> CO - Corallo
<input type="radio"/> SM - Smeraldo	<input type="radio"/> NI - Ninfea
<input type="radio"/> AL - Alga	<input type="radio"/> AM - Anemone

art. **DECR226L** / art. **DECR226LSF**
 art. **DECR226E** / art. **DECR226ESF**

art. **DECRD226E** / art. **DECRD226ESF**

FINITURE MOBILE IN LEGNO CON ANTA FRONTALE IN LISTELLI

WOODEN CABINET FINISHES WITH FRONT DOOR IN SOLID WOODEN STRIPS

essenze legno/wood essences

- RO - Rovere Nero
- RT - Rovere Tinto Noce
- RS - Rovere Sbiancato
- RN - Rovere Naturale
- EU - Eucalipto

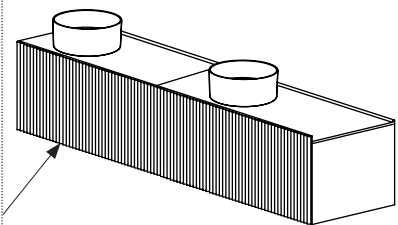

FINITURE MOBILE IN LEGNO VERSIONE LISCIA

WOODEN CABINET FINISHES - SMOOTH VERSION

<p>laccature/laquerings</p> <ul style="list-style-type: none"> <input type="radio"/> TL - Talco <input type="radio"/> PM - Pomice <input type="radio"/> BR - Brina <input type="radio"/> AN - Arenaria <input type="radio"/> AV - Avena <input type="radio"/> CM - Cemento <input type="radio"/> BA - Basalto <input type="radio"/> MU - Muschio <input type="radio"/> AG - Agave 	<p>Le Acque di Cielo</p> <ul style="list-style-type: none"> <input type="radio"/> OL - Oltremare <input type="radio"/> SM - Smeraldo <input type="radio"/> AL - Alga <input type="radio"/> CO - Corallo <input type="radio"/> NI - Ninfea <input type="radio"/> AM - Anemone <input type="radio"/> FU - Fumo - glossy <input type="radio"/> TP - Talpa - glossy 	<p>essenze legno/wood essences</p> <ul style="list-style-type: none"> <input type="radio"/> RO - Rovere Nero <input type="radio"/> RT - Rovere Tinto Noce <input type="radio"/> RS - Rovere Sbiancato <input type="radio"/> RN - Rovere Naturale <input type="radio"/> EU - Eucalipto
--	---	--

Indicare la bacinella (quantità bacinelle 1 o 2)
 Indicate the bowl (quantity of 1 or 2 bowls)

CALAT45 ø45 x 16 h	CALA055 55 x 42 x 16 h	BATO ø43 x 19 h	BATA ø45 x 26 h	BAECO 62 x 45 x 18 h	BAEC058 58 x 42 x 16,5 h	THL40 55 x 40 x 16 h	THLAT ø40 x 16 h	BAERA ø45 x 24 h	BAERA40 ø40 x 15 h	SHBA40 ø40 x 18,5 h
1 <input type="checkbox"/> 2 <input type="checkbox"/>	1 <input type="checkbox"/> 2 <input type="checkbox"/>	1 <input type="checkbox"/> 2 <input type="checkbox"/>	1 <input type="checkbox"/> 2 <input type="checkbox"/>	1 <input type="checkbox"/> 2 <input type="checkbox"/>	1 <input type="checkbox"/> 2 <input type="checkbox"/>	1 <input type="checkbox"/> 2 <input type="checkbox"/>	1 <input type="checkbox"/> 2 <input type="checkbox"/>	1 <input type="checkbox"/> 2 <input type="checkbox"/>	1 <input type="checkbox"/> 2 <input type="checkbox"/>	1 <input type="checkbox"/> 2 <input type="checkbox"/>

DATA _____
 DATE _____

FIRMA DEL CLIENTE _____
 SIGNATURE _____

ATTENZIONE:
 La rappresentazione delle finiture è puramente indicativa. Verificare le finiture con le relative cartelle.
 Ogni oggetto possiede la peculiarità di essere elaborato secondo principi puramente tradizionali, in modo da garantirne l'assoluta originalità ed unicità. Le eventuali piccole variazioni di colore, tono o venature fra gli articoli sono da considerarsi pregi e non difetti, in quanto garanzia della fattura manuale del prodotto, che fa di ogni oggetto Cielo un pezzo unico ed esclusivo, lontano dall'omologazione industriale. In fase d'ordine si intendono, pertanto, accettate tali tolleranze che non possono dare adito a contestazioni di alcun genere.
 Verificare sempre le disponibilità e i tempi di consegna con il commerciale.

ATTENTION:
 The representation of the finishes is merely indicative. Please choose the finishes using the folders.
 Every item possesses that particular feature of being processed according to purely traditional principles that guarantee its absolute originality and uniqueness. The small variations in colour, hues or streaks on the items are to be considered as qualities and not defects, since they warranty the handcrafted processing which makes each Cielo item a unique and exclusive piece that cannot be compared to industrial standardization. When making the order, the client implicitly accepts those various features that may give rise to claims of any sort.
 Always check the availability and delivery time with the commercial department.

Delfo 76 ceramic top

cielo

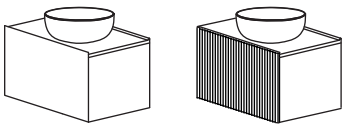
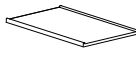
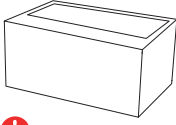
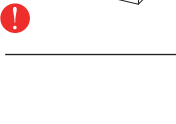
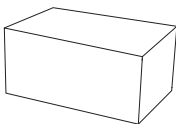
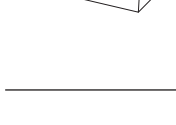
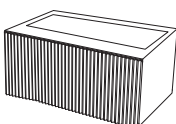
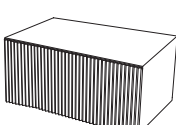
	Size (cm) Medidas Dimensions Maße Размеры	Product code Artículo Article Artikel Артикул	Net weight (kg) Peso neto Poids net Reingewicht вес нетто	Finishes Acabados Finitions Farbe Отделка	Euro Евро
 <p>Ceramic rectangular countertop \ Top en cerámica \ Plan en céramique \ Platte aus Keramik \ керамическая столешница</p> <p>!</p>	76 x 48 x h 3	DEPIR76(X)* DEPIR76SF(X)* no tap hole sin agujero sans orifice ohne Loch без отверстия		<ul style="list-style-type: none"> Gloss White *X = N - Gloss Black *X = FU - Fumo *X = TP - Talpa Le Terre di Cielo Le Acque di Cielo 	396,00 506,00 506,00 506,00 506,00 506,00
<p>N.B. Tap/Faucet hole on request (mandatory position – see technical data sheet and order form). \ Orificio grifo a petición (posición obligada-veáse ficha técnica y módulo de pedido) \ N.B. : Trou de robinet sur demande (position obligée – voir fiche technique et bon de commande) \ Hinweis: Hahnloch auf Anfrage (Position obligatorisch – siehe technisches Datenblatt und Bestellformular) \ P.S. Отверстие под смеситель по запросу (возможное место расположения отверстия – проверьте на технической карте изделия и модуле заказа)</p>					25,00
 <p>Lacquered cabinet Mueble lacado \ Meuble laqué \ Möbel lackiert \ Тумба крашенная</p> <p>!</p>	76 x 50 x h 43,5	DECR76L(X)*		<ul style="list-style-type: none"> Le Terre di Cielo * Le Acque di Cielo *X = FU - Fumo *X = TP - Talpa 	1458,00 1634,00 1634,00 1634,00
 <p>Cabinet in wooden finish Mueble en madera \ Meuble bois \ Möbel aus Holz \ Тумба в деревянной отделке</p> <p>!</p>	76 x 50 x h 43,5	DECR76E(X)*		<ul style="list-style-type: none"> Essenze Rovere • *X = EU - Eucalipto 	1733,00 1901,00
 <p>Lacquered cabinet without holes Mueble lacado sin agujero \ Meuble laqué sans orifice \ Möbel lackiert ohne Hahnloch \ Тумба крашенная без отверстия</p>	76 x 50 x h 43,5	DECR76LSF(X)*		<ul style="list-style-type: none"> Le Terre di Cielo * Le Acque di Cielo *X = FU - Fumo *X = TP - Talpa 	1458,00 1634,00 1634,00 1634,00
 <p>Cabinet in wooden finish without holes Mueble en madera sin agujero \ Meuble bois sans orifice \ Möbel aus Holz ohne Hahnloch \ Тумба в деревянной отделке без отверстия</p>	76 x 50 x h 43,5	DECR76ESF(X)*		<ul style="list-style-type: none"> Essenze Rovere • *X = EU - Eucalipto 	1733,00 1901,00
 <p>Cabinet with front drawer in solid triangular wooden strips Mueble con frontal de cajón en listones triangulares de madera maciza en madera \ Armoire avec façade de tiroir en bandes de bois massif triangulaires en essence \ Möbel mit Frontschublade aus dreieckigen Massivholzleisten \ Тумба с вертикальными планками из цельного дерева на фасаде</p> <p>!</p>	76 x 50 x h 43,5	DECRD76E(X)*		<ul style="list-style-type: none"> Essenze Rovere • *X = EU - Eucalipto 	3075,00 3381,00
 <p>Cabinet with front drawer in solid triangular wooden strips without holes Mueble con frontal de cajón en listones triangulares de madera maciza en madera sin agujero \ Armoire avec façade de tiroir en bandes de bois massif triangulaires en essence sans orifice \ Möbel mit Frontschublade aus dreieckigen Massivholzleisten ohne Hahnloch \ Тумба с вертикальными планками из цельного дерева на фасаде без отверстия</p>	76 x 50 x h 43,5	DECRD76ESF(X)*		<ul style="list-style-type: none"> Essenze Rovere • *X = EU - Eucalipto 	3075,00 3381,00

! **mandatory combination: on top Cielo washbasin + top + cabinet with holes**
 combinaison obligatoire: cubela de apoyo Cielo + encimera + mueble los agujeros \ combinación obligatoria: vasque à poser Cielo + plan + meuble con orifice \ obligatorische Kombination: Aufsatzbecken Cielo + Holzregal + Möbel mit Hahnloch \ обязательное сочетание: Накладная Cielo + столешница + Тумба con отверстия

Technical symbols legend
 Símbolos técnicos clave / Légende symboles techniques / Technische Zeichenerklärung / Перечень технических символов

 **all sides are enamelled**
 con todos los lados esmaltados
 avec tous les côtés émaillés
 alle Seiten glasiert
 все стороны покрыты эмалью

 **no tap holes**
 sin agujero para grifo
 sans orifice robinet
 ohne Hahnloch
 без отверстия под смеситель





































 **without overflow**
 sin rebosadero
 sans trop-plein
 ohne Überlauf
 без слива-перелива

 **on top installation**
 instalación de apoyo
 installation à partir du plan
 Montage auf Platte
 установка на столешницу

Delfo 76 ceramic top

drains and siphons | desagües y sifones | les drains et les siphons |
Ablaufgarnituren und Siphons | Донные клапаны и сифоны

cielo

	Product code Artículo Article Artikel Артикул	Net weight(Kg) Peso neto Poids net Reingewicht вес нетто	Finishes Acabados Finitions Farbe Отделки	Euro Евро
 <p>Universal click/clack drain in CHROME with ceramic lid Válvula universal clic/clack Cromado con tapa en cerámica \ Bonde universelle clic/clac Chromé avec clapet en céramique \ Universal-Ablaufgarnitur Click-Clack Chrom mit Keramikstopfen \ Универсальный донный клапан click/clack хром с керамической крышкой</p>	PIL01(X)*	0,40	<ul style="list-style-type: none">  Gloss White  Gloss Black  FU - Fumo  TP - Talpa  Le Terre di Cielo  Le Acque di Cielo 	<p>95,00</p> <p>114,00</p> <p>139,00</p> <p>139,00</p> <p>139,00</p> <p>139,00</p>
 <p>Universal click/clack drain in BLACK MATT finish with ceramic lid Válvula universal clic/clack Negro Matt con tapa en cerámica \ Bonde universelle clic/clac Noir Matt avec clapet en céramique \ Universal-Ablaufgarnitur Click-Clack Matt Schwarz mit Keramikstopfen \ Универсальный донный клапан click/clack черный матовый с керамической крышкой</p>	PIL01NM(X)*	0,40	<ul style="list-style-type: none">  Gloss White  Gloss Black  FU - Fumo  TP - Talpa  Le Terre di Cielo  Le Acque di Cielo 	<p>120,00</p> <p>159,00</p> <p>169,00</p> <p>169,00</p> <p>169,00</p> <p>169,00</p>
 <p>Universal click/clack drain in CEMENTO finish with ceramic lid Válvula universal clic/clack Cemento con tapa en cerámica \ Bonde universelle clic/clac Cemento avec clapet en céramique \ Universal-Ablaufgarnitur Click-Clack Cement mit Keramikstopfen \ Универсальный донный клапан click/clack с керамической крышкой</p>	PIL01CM(X)*	0,40	<ul style="list-style-type: none">  Gloss White  Gloss Black  FU - Fumo  TP - Talpa  Le Terre di Cielo  Le Acque di Cielo 	<p>120,00</p> <p>159,00</p> <p>169,00</p> <p>169,00</p> <p>169,00</p> <p>169,00</p>
 <p>Universal click/clack drain in BRONZE with ceramic lid Válvula universal clic/clack Bronce con tapa en cerámica \ Bonde universelle clic/clac Bronze avec clapet en céramique \ Universal-Ablaufgarnitur Click-Clack Bronze mit Keramikstopfen \ Универсальный донный клапан click/clack бронза с керамической крышкой</p>	PIL01BR(X)*	0,40	<ul style="list-style-type: none">  Gloss White  Gloss Black  FU - Fumo  TP - Talpa  Le Terre di Cielo  Le Acque di Cielo 	<p>135,00</p> <p>171,00</p> <p>182,00</p> <p>182,00</p> <p>182,00</p> <p>182,00</p>
 <p>CHROMED siphon Sifone Cromado \ Siphon Chromé \ Siphon Verchromt \ сифон Chrome</p>	SISP	0,93	 Chrome	133,00
 <p>MATT BLACK siphon Sifone Negro Mate \ Siphon Noir Mat \ Siphon Schwarz Matt \ Сифон Черный матовый</p>	SIFN	0,93	 Matt Black	194,00
 <p>CEMENTO siphon Sifone Cemento \ Siphon Cemento \ Siphon Cemento \ сифон Cemento</p>	SIFCM	0,93	 Cemento	194,00
 <p>BRONZE siphon Sifone Bronce \ Siphon Bronze \ Siphon Bronze \ бронза сифон</p>	SIFBR	0,93	 Bronze	220,00

Terre di Cielo available for washbasins and ceramic shelf | Terre di Cielo disponibles para el lavabo y la encimara de cerámica | Terre di Cielo disponibles pour le lavabo et le plan en céramique | Für Waschbecken und Keramikplatte erhältliche Terre di Cielo | Отделка Terre di Cielo доступны для раковины и керамических столешниц



Acque di Cielo available for washbasins and ceramic shelf | Acque di Cielo disponibles para el lavabo y la encimara de cerámica | Acque di Cielo disponibles pour le lavabo et le plan en céramique | Für Waschbecken und Keramikplatte erhältliche Acque di Cielo | Отделка Acque di Cielo доступны для раковины и керамических столешниц

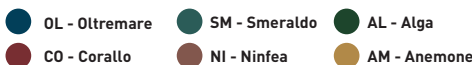

* Terre di Cielo laquering available for cabinet | lacados Terre di Cielo disponibles para mueble | laquages Terre di Cielo disponibles pour le meuble | Für Möbel erhältliche Lackierungen Terre di Cielo | крашенная отделка Terre di Cielo доступна для ящика и столешницы











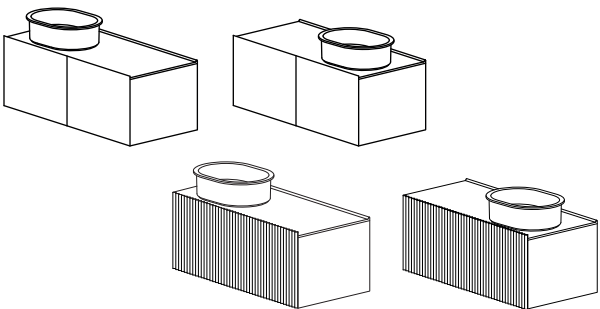







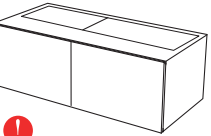



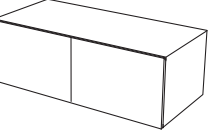

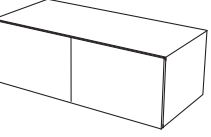

• Oak finishes available for the cabinet - a smooth version and a version with the front door in solid triangular wooden strips | Essenze Rovere disponibile para el mueble en versión lisa o versión con puerta frontal con tiras de madera maciza triangulares | Essences Chêne disponibles pour le meuble en version lisse et en version avec porte frontale ornée de listels triangulaires en essence de bois massif | Holzarten Eiche für das Möbel in glatter Ausführung und in der Ausführung mit Fronttür aus dreieckigen Massivholzleisten erhältlich | Натуральные шпоны дуба доступны для тумбы с гладкой поверхностью и тумбы с передней дверцей из массива бруса треугольной формы из натурального шпона дерева

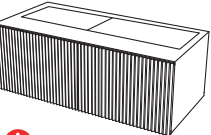

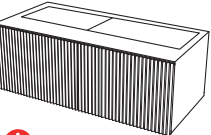
Delfo 113 ceramic top

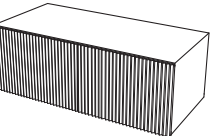
cielo

	Size (cm) Medidas Dimensions Maße Размеры	Product code Artículo Article Artikel Артикул	Net weight (Kg) Peso neto Poids net Reingewicht вес нетто	Finishes Acabados Finitions Farbe Отделка	Euro Евро
 <p>Ceramic rectangular countertop \ Top en cerámica \ Plan en céramique \ Platte aus Keramik \ керамическая столешница</p> <p>!</p>	113 x 48 x h 3	DEPIR(X)* DEPIRSF(X)* no tap hole sin agujero sans orifice ohne Loch без отверстия		<ul style="list-style-type: none">  Gloss White  *X = N - Gloss Black  *X = FU - Fumo  *X = TP - Talpa  Le Terre di Cielo  Le Acque di Cielo 	457,00 638,00 638,00 638,00 638,00 638,00
<p>N.B. Tap/Faucet hole on request (mandatory position – see technical data sheet and order form). \ Orificio grifo a petición (posición obligada-veáse ficha técnica y módulo de pedido) \ N.B. : Trou de robinet sur demande (position obligée – voir fiche technique et bon de commande) \ Hinweis: Hahnloch auf Anfrage (Position obligatorisch – siehe technisches Datenblatt und Bestellformular) \ P.S. Отверстие под смеситель по запросу (возможное место расположения отверстия – проверьте на технической карте изделия и модуле заказа)</p>					25,00
 <p>Lacquered cabinet Mueble lacado \ Meuble laqué \ Möbel lackiert \ Тумба крашенная</p> <p>!</p>	113 x 50 x h 43,5	DECRL(X)*		<ul style="list-style-type: none">  Le Terre di Cielo *  Le Acque di Cielo  *X = FU - Fumo  *X = TP - Talpa 	1649,00 1891,00 1891,00 1891,00
 <p>Cabinet in wooden finish Mueble en madera \ Meuble bois \ Möbel aus Holz \ Тумба в деревянной отделке</p> <p>!</p>	113 x 50 x h 43,5	DECRE(X)*		<ul style="list-style-type: none">  EsSENze Rovere •  *X = EU - Eucalipto 	2228,00 2471,00
 <p>Lacquered cabinet without holes Mueble lacado sin agujero \ Meuble laqué sans orifice \ Möbel lackiert ohne Hahnloch \ Тумба крашенная без отверстия</p>	113 x 50 x h 43,5	DECRLSF(X)*		<ul style="list-style-type: none">  Le Terre di Cielo *  Le Acque di Cielo  *X = FU - Fumo  *X = TP - Talpa 	1649,00 1891,00 1891,00 1891,00
 <p>Cabinet in wooden finish without holes Mueble en madera sin agujero \ Meuble bois sans orifice \ Möbel aus Holz ohne Hahnloch \ Тумба в деревянной отделке без отверстия</p>	113 x 50 x h 43,5	DECRESF(X)*		<ul style="list-style-type: none">  EsSENze Rovere •  *X = EU - Eucalipto 	2228,00 2471,00
 <p>Cabinet with front drawer in solid triangular wooden strips Mueble con frontal de cajón en listones triangulares de madera maciza en madera \ Armoire avec façade de tiroir en bandes de bois massif triangulaires en essence \ Möbel mit Frontschublade aus dreieckigen Massivholzleisten \ Тумба с вертикальными планками из цельного дерева на фасаде</p> <p>!</p>	113 x 50 x h 43,5	DECRL(X)*		<ul style="list-style-type: none">  EsSENze Rovere •  *X = EU - Eucalipto 	4316,00 4693,00
 <p>Cabinet with front drawer in solid triangular wooden strips without holes Mueble con frontal de cajón en listones triangulares de madera maciza en madera sin agujero \ Armoire avec façade de tiroir en bandes de bois massif triangulaires en essence sans orifice \ Möbel mit Frontschublade aus dreieckigen Massivholzleisten ohne Hahnloch \ Тумба с вертикальными планками из цельного дерева на фасаде без отверстия</p>	113 x 50 x h 43,5	DECRLSF(X)*		<ul style="list-style-type: none">  EsSENze Rovere •  *X = EU - Eucalipto 	4316,00 4693,00

! **mandatory combination: on top Cielo washbasin + top + cabinet with holes**
 combinaison obligatoire: cubela de apoyo Cielo + encimera + mueble los agujeros \ combinación obligatoria: vasque à poser Cielo + plan + mueble con orifice \ obligatorische Kombination: Aufsatzbecken Cielo + Holzregal + Möbel mit Hahnloch \ обязательное сочетание: Накладная Cielo + столешница + Тумба с отверстием

Technical symbols legend
 Símbolos técnicos clave / Légende symboles techniques / Technische Zeichenerklärung / Перечень технических символов

 **all sides are enamelled**
 con todos los lados esmaltados avec tous les côtés émaillés alle-Seiten glasiert все стороны покрыты эмалью

 **no tap holes**
 sin agujero para grifo sans orifice robinet ohne Hahnloch без отверстия под смеситель

 **without overflow**
 sin rebosadero sans trop-plein ohne Überlauf без слива-перелива





































 **on top installation**
 instalación de apoyo installation à partir du plan Montage auf Platte установка на столешницу

Delfo 113

ceramic top

drains and siphons / desagües y sifones / les drains et les siphons /
Ablaufgarnituren und Siphons / Донные клапаны и сифоны

cielo

	Product code Artículo Article Artikel Артикул	Net weight (Kg) Peso neto Poids net Reingewicht вес нетто	Finishes Acabados Finitions Farbe Отделки	Euro Евро
 <p>Universal click/clack drain in CHROME with ceramic lid Válvula universal click/clack Cromado con tapa en cerámica \ Bonde universelle clic/clac Chromé avec clapet en céramique \ Universal-Ablaufgarnitur Click-Clack Chrom mit Keramikstopfen \ Универсальный донный клапан click/clack хром с керамической крышкой</p>	PIL01(X)*	0,40	<ul style="list-style-type: none">  Gloss White  *X = N - Gloss Black  *X = FU - Fumo  *X = TP - Talpa  Le Terre di Cielo  Le Acque di Cielo 	<p>95,00</p> <p>114,00</p> <p>139,00</p> <p>139,00</p> <p>139,00</p> <p>139,00</p>
 <p>Universal click/clack drain in BLACK MATT finish with ceramic lid Válvula universal click/clack Negro Matt con tapa en cerámica \ Bonde universelle clic/clac Noir Matt avec clapet en céramique \ Universal-Ablaufgarnitur Click-Clack Matt Schwarz mit Keramikstopfen \ Универсальный донный клапан click/clack черный матовый с керамической крышкой</p>	PIL01NM(X)*	0,40	<ul style="list-style-type: none">  Gloss White  *X = N - Gloss Black  *X = FU - Fumo  *X = TP - Talpa  Le Terre di Cielo  Le Acque di Cielo 	<p>120,00</p> <p>159,00</p> <p>169,00</p> <p>169,00</p> <p>169,00</p> <p>169,00</p>
 <p>Universal click/clack drain in CEMENTO finish with ceramic lid Válvula universal click/clack Cemento con tapa en cerámica \ Bonde universelle clic/clac Cemento avec clapet en céramique \ Universal-Ablaufgarnitur Click-Clack Cement mit Keramikstopfen \ Универсальный донный Cemento click/clack с керамической крышкой</p>	PIL01CM(X)*	0,40	<ul style="list-style-type: none">  Gloss White  *X = N - Gloss Black  *X = FU - Fumo  *X = TP - Talpa  Le Terre di Cielo  Le Acque di Cielo 	<p>120,00</p> <p>159,00</p> <p>169,00</p> <p>169,00</p> <p>169,00</p> <p>169,00</p>
 <p>Universal click/clack drain in BRONZE with ceramic lid Válvula universal click/clack Bronce con tapa en cerámica \ Bonde universelle clic/clac Bronze avec clapet en céramique \ Universal-Ablaufgarnitur Click-Clack Bronze mit Keramikstopfen \ Универсальный донный клапан click/clack бронза с керамической крышкой</p>	PIL01BR(X)*	0,40	<ul style="list-style-type: none">  Gloss White  *X = N - Gloss Black  *X = FU - Fumo  *X = TP - Talpa  Le Terre di Cielo  Le Acque di Cielo 	<p>135,00</p> <p>171,00</p> <p>182,00</p> <p>182,00</p> <p>182,00</p> <p>182,00</p>
 <p>CHROMED siphon Sifone Cromado \ Siphon Chromé \ Siphon Verchromt \ сифон Chrome</p>	SISP	0,93	 Chrome	133,00
 <p>MATT BLACK siphon Sifone Negro Mate \ Siphon Noir Mat \ Siphon Schwarz Matt \ Сифон Черный матовый</p>	SIFN	0,93	 Matt Black	194,00
 <p>CEMENTO siphon Sifone Cemento \ Siphon Cemento \ Siphon Cemento \ сифон Cemento</p>	SIFCM	0,93	 Cemento	194,00
 <p>BRONZE siphon Sifone Bronce \ Siphon Bronze \ Siphon Bronze \ бронза сифон</p>	SIFBR	0,93	 Bronze	220,00

Terre di Cielo available for washbasins and ceramic shelf / Terre di Cielo disponibles para el lavabo y la encimara de cerámica / Terre di Cielo disponibles pour le lavabo et le plan en céramique / Für Waschbecken und Keramikplatte erhältliche Terre di Cielo / Отделки Terre di Cielo доступны для раковины и керамических столешниц



Acque di Cielo available for washbasins and ceramic shelf / Acque di Cielo disponibles para el lavabo y la encimara de cerámica / Acque di Cielo disponibles pour le lavabo et le plan en céramique / Für Waschbecken und Keramikplatte erhältliche Acque di Cielo / Отделки Acque di Cielo доступны для раковины и керамических столешниц



* Terre di Cielo laquering available for cabinet / lacados Terre di Cielo disponibles para mueble / laquages Terre di Cielo disponibles pour le meuble / Für Möbel erhältliche Lackierungen Terre di Cielo / крашенная отделка Terre di Cielo доступна для ящика и столешницы











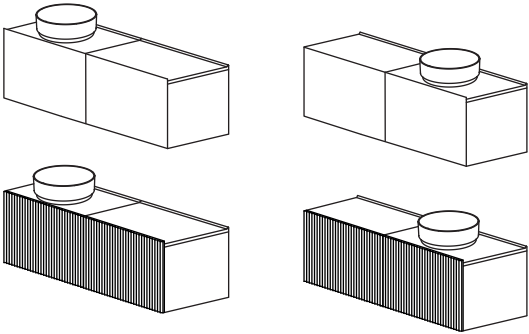
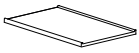



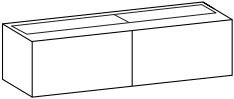

• Oak finishes available for the cabinet - a smooth version and a version with the front door in solid triangular wooden strips / Essenze Rovere disponibile para el mueble en versión lisa o versión con puerta frontal con tiras de madera maciza triangulares / Essences Chêne disponibles pour le meuble en version lisse et en version avec porte frontale ornée de listels triangulaires en essence de bois massif / Holzarten Eiche für das Möbel in glatter Ausführung und in der Ausführung mit Fronttür aus dreieckigen Massivholzleisten erhältlich / Натуральные шпоны дуба доступны для тумбы с гладкой поверхностью и тумбы с передней дверцей из массива бруса треугольной формы из натурального шпона дерева

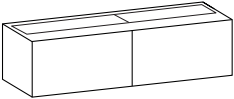

Delfo 152 ceramic top

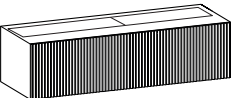
cielo

	Size (cm) Medidas Dimensions Maße Размеры	Product code Artículo Article Artikel Артикул	Net weight (kg) Peso neto Poids net Reingewicht вес нетто	Finishes Acabados Finitions Farbe Отделка	Euro Евро
 <p>Ceramic rectangular countertop \ Top en cerámica \ Plan en céramique \ Platte aus Keramik \ керамическая столешница</p>	76 x 48 x h 3	DEPIR76(X)* DEPIR76SF(X)* no tap hole sin agujero sans orifice ohne Loch без отверстия		<ul style="list-style-type: none">  Gloss White  *X = N - Gloss Black  *X = FU - Fumo  *X = TP - Talpa  Le Terre di Cielo  Le Acque di Cielo 	396,00 506,00 506,00 506,00 506,00 506,00
<p>N.B. Tap/Faucet hole on request (mandatory position – see technical data sheet and order form). \ Orificio grifo a petición (posición obligada-veáse ficha técnica y módulo de pedido) \ N.B. : Trou de robinet sur demande (position obligée – voir fiche technique et bon de commande) \ Hinweis: Hahnloch auf Anfrage (Position obligatorisch – siehe technisches Datenblatt und Bestellformular) \ P.S. Отверстие под смеситель по запросу (возможное место расположения отверстия – проверьте на технической карте изделия и модуле заказа)</p>					25,00
 <p>Lacquered cabinet Mueble lacado \ Meuble laqué \ Möbel lackiert \ Тумба крашенная</p>	152 x 50 x h 43,5	DECR152L(X)*		<ul style="list-style-type: none">  Le Terre di Cielo *  Le Acque di Cielo  *X = FU - Fumo  *X = TP - Talpa 	2396,00 2752,00 2752,00 2752,00
 <p>Cabinet in wooden finish Mueble en madera \ Meuble bois \ Möbel aus Holz \ Тумба в деревянной отделке</p>	152 x 50 x h 43,5	DECR152E(X)*		<ul style="list-style-type: none">  EsSENze Rovere •  *X = EU - Eucalipto 	3158,00 3465,00
 <p>Cabinet with front drawer in solid triangular wooden strips Mueble con frontal de cajón en listones triangulares de madera maciza en madera \ Armoire avec façade de tiroir en bandes de bois massif triangulaires en essence \ Möbel mit Frontschublade aus dreieckigen Massivholzleisten \ Тумба с вертикальными планками из цельного дерева на фасаде</p>	152 x 50 x h 43,5	DECRD152E(X)*		<ul style="list-style-type: none">  EsSENze Rovere •  *X = EU - Eucalipto 	5203,00 5658,00

**mandatory combination:
on top Cielo washbasin +
top + cabinet with holes**

combinaison obligatoire: cubela de apoyo Cielo + encimera + mueble los agujeros \ combinación obligatoria: vasque à poser Cielo + plan + meuble con orifice \ obligatorische Kombination: Aufsatzbecken Cielo + Holzregal + Möbel mit Hahnloch \ обязательное сочетание: Накладная Cielo + столешница + Тумба с отверстия

Technical symbols legend
 Símbolos técnicos clave
 / Légende symboles techniques / Technische Zeichenerklärung / Перечень технических символов

 **all sides are enamelled**
 con todos los lados esmaltados
 avec tous les côtés émaillés
 alle Seiten glasiert
 все стороны покрыты эмалью

 **no tap holes**
 sin agujero para grifo
 sans orifice robinet
 ohne Hahnloch
 без отверстия под смеситель

 **without overflow**
 sin rebosadero
 sans trop-plein
 ohne Überlauf
 без слива-перелива





































 **on top installation**
 instalación de apoyo
 installation à partir du plan
 Montage auf Platte
 установка на столешницу

Delfo 152

ceramic top

drains and siphons / desagües y sifones / les drains et les siphons /
Ablaufgarnituren und Siphons / Донные клапаны и сифоны

cielo

	Product code Artículo Article Artikel Артикул	Net weight(Kg) Peso neto Poids net Reingewicht вес нетто	Finishes Acabados Finitions Farbe Отделка	Euro Евро
 Universal click/clack drain in CHROME with ceramic lid Válvula universal click/clack Cromado con tapa en cerámica \ Bonde universelle clic/clac Chromé avec clapet en céramique \ Universal-Ablaufgarnitur Click-Clack Chrom mit Keramikstopfen \ Универсальный донный клапан click/clack хром с керамической крышкой	PIL01(X)*	0,40	<ul style="list-style-type: none">  Gloss White  *X = N - Gloss Black  *X = FU - Fumo  *X = TP - Talpa  Le Terre di Cielo  Le Acque di Cielo 	<ul style="list-style-type: none"> 95,00 114,00 139,00 139,00 139,00 139,00
 Universal click/clack drain in BLACK MATT finish with ceramic lid Válvula universal click/clack Negro Matt con tapa en cerámica \ Bonde universelle clic/clac Cemento avec clapet en céramique \ Universal-Ablaufgarnitur Click-Clack Matt Schwarz mit Keramikstopfen \ Универсальный донный клапан click/clack черный матовый с керамической крышкой	PIL01NM(X)*	0,40	<ul style="list-style-type: none">  Gloss White  *X = N - Gloss Black  *X = FU - Fumo  *X = TP - Talpa  Le Terre di Cielo  Le Acque di Cielo 	<ul style="list-style-type: none"> 120,00 159,00 169,00 169,00 169,00 169,00
 Universal click/clack drain in CEMENTO finish with ceramic lid Válvula universal click/clack Cemento con tapa en cerámica \ Bonde universelle clic/clac Cemento avec clapet en céramique \ Universal-Ablaufgarnitur Click-Clack Cement mit Keramikstopfen \ Универсальный донный Cemento click/clack с керамической крышкой	PIL01CM(X)*	0,40	<ul style="list-style-type: none">  Gloss White  *X = N - Gloss Black  *X = FU - Fumo  *X = TP - Talpa  Le Terre di Cielo  Le Acque di Cielo 	<ul style="list-style-type: none"> 120,00 159,00 169,00 169,00 169,00 169,00
 Universal click/clack drain in BRONZE with ceramic lid Válvula universal click/clack Bronce con tapa en cerámica \ Bonde universelle clic/clac Bronze avec clapet en céramique \ Universal-Ablaufgarnitur Click-Clack Bronce mit Keramikstopfen \ Универсальный донный клапан click/clack бронза с керамической крышкой	PIL01BR(X)*	0,40	<ul style="list-style-type: none">  Gloss White  *X = N - Gloss Black  *X = FU - Fumo  *X = TP - Talpa  Le Terre di Cielo  Le Acque di Cielo 	<ul style="list-style-type: none"> 135,00 171,00 182,00 182,00 182,00 182,00
 CHROMED siphon Sifone Cromado \ Siphon Chromé \ Siphon Verchromt \ сифон Chrome	SISP	0,93	 Chrome	133,00
 MATT BLACK siphon Sifone Negro Mate \ Siphon Noir Mat \ Siphon Schwarz Matt \ Сифон Черный матовый	SIFN	0,93	 Matt Black	194,00
 CEMENTO siphon Sifone Cemento \ Siphon Cemento \ Siphon Cemento \ сифон Cemento	SIFCM	0,93	 Cemento	194,00
 BRONZE siphon Sifone Bronce \ Siphon Bronce \ Siphon Bronce \ бронза сифон	SIFBR	0,93	 Bronze	220,00







Terre di Cielo available for washbasins and ceramic shelf / Terre di Cielo disponibles para el lavabo y la encimara de cerámica / Terre di Cielo disponibles pour le lavabo et le plan en céramique / Für Waschbecken und Keramikplatte erhältliche Terre di Cielo / Отделка Terre di Cielo доступны для раковины и керамических столешниц

-  TL - Talco
-  PM - Pomice
-  BR - Brina
-  BA - Basalto
-  LV - Lavagna
-  CM - Cemento
-  FN - Fango
-  CA - Cacao
-  AN - Arenaria
-  AV - Avena
-  LN - Lino
-  AG - Agave
-  MU - Muschio
-  PL - Polvere
-  CP - Cipria
-  CN - Canapa

Acque di Cielo available for washbasins and ceramic shelf / Acque di Cielo disponibles para el lavabo y la encimara de cerámica / Acque di Cielo disponibles pour le lavabo et le plan en céramique / Für Waschbecken und Keramikplatte erhältliche Acque di Cielo / Отделка Acque di Cielo доступны для раковины и керамических столешниц

-  OL - Oltremare
-  SM - Smeraldo
-  AL - Alga
-  CO - Corallo
-  NI - Ninfea
-  AM - Anemone

* Terre di Cielo laquering available for cabinet / lacados Terre di Cielo disponibles para mueble / laquages Terre di Cielo disponibles pour le meuble / Für Möbel erhältliche Lackierungen Terre di Cielo / крашенная отделка Terre di Cielo доступна для ящика и столешницы

-  TL - Talco
-  PM - Pomice
-  BR - Brina
-  BA - Basalto
-  CM - Cemento
-  AN - Arenaria
-  MU - Muschio
-  AG - Agave
-  AV - Avena

• Oak finishes available for the cabinet - a smooth version and a version with the front door in solid triangular wooden strips / Essenze Rovere disponibile para el mueble en versión lisa o versión con puerta frontal con tiras de madera maciza triangulares / Essences Chêne disponibles pour le meuble en version lisse et en version avec porte frontale ornée de listels triangulaires en essence de bois massif / Holzarten Eiche für das Möbel in glatter Ausführung und in der Ausführung mit Fronttür aus dreieckigen Massivholzleisten erhältlich / Натуральные шпоны дуба доступны для тумбы с гладкой поверхностью и тумбы с передней дверцей из массива бруса треугольной формы из натурального шпона дерева

-  RS - Rovere Sbiancato
-  RN - Rovere Naturale
-  RN - Rovere Nero
-  RT - Rovere Tinto Noce

Delfo 152 ceramic top

cielo

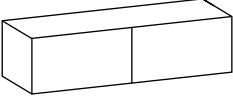
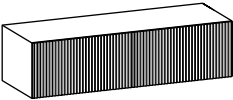
	Size (cm) Medidas Dimensions Maße Размеры	Product code Artículo Article Artikel Артикул	Net weight (kg) Peso neto Poids net Reingewicht вес нетто	Finishes Acabados Finitions Farbe Отделки	Euro Евро
 <p>Lacquered cabinet without holes Mueble lacado sin agujero \ Meuble laqué sans orifice \ Möbel lackiert ohne Hahnloch \ Тумба крашенная без отверстия</p>	152 x 50 x h 43,5	DECR152LSF(X)*		<ul style="list-style-type: none"> ● Le Terre di Cielo * ● Le Acque di Cielo ● *X = FU - Fumo ● *X = TP - Talpa 	<p>2396,00</p> <p>2752,00</p> <p>2752,00</p> <p>2752,00</p>
				<p>Cabinet in wooden finish without holes Mueble en madera sin agujero \ Meuble bois sans orifice \ Möbel aus Holz ohne Hahnloch \ Тумба в деревянной отделке без отверстия</p>	152 x 50 x h 43,5
 <p>Cabinet with front drawer in solid triangular wooden strips without holes Mueble con frontal de cajón en listones triangulares de madera maciza en madera sin agujero \ Armoire avec façade de tiroir en bandes de bois massif triangulaires en essence sans orifice \ Möbel mit Frontschublade aus dreieckigen Massivholzleisten ohne Hahnloch \ Тумба с вертикальными планками из цельного дерева на фасаде, без отверстия</p>	152 x 50 x h 43,5	DECRD152ESF(X)*		<ul style="list-style-type: none"> ● Essenze Rovere • 	5203,00
				<ul style="list-style-type: none"> ● *X = EU - Eucalipto 	5658,00

* **Terre di Cielo laquering available for cabinet** / lacados Terre di Cielo disponibles para mueble | laquages Terre di Cielo disponibles pour le meuble | Für Möbel erhältliche Lackierungen Terre di Cielo | крашенная отделка Terre di Cielo доступна для ящика и столешницы











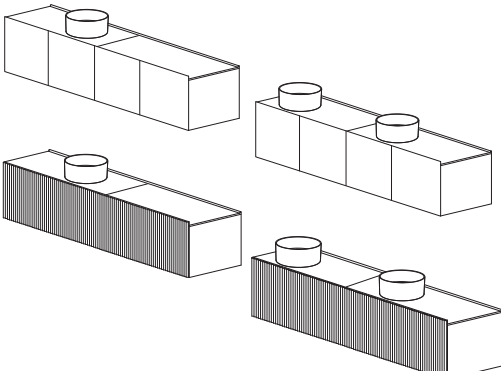



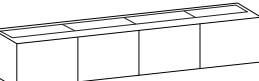

● TL - Talco
 ● PM - Pomice
 ● BR - Brina
 ● BA - Basalto
 ● CM - Cemento
● AN - Arenaria
 ● MU - Muschio
 ● AG - Agave
 ● AV - Avena

• **Oak finishes available for the cabinet - a smooth version and a version with the front door in solid triangular wooden strips** / *Essenze Rovere* disponible para el mueble en versión lisa o versión con puerta frontal con tiras de madera maciza triangulares | *Essences Chêne* disponibles pour le meuble en version lisse et en version avec porte frontale ornée de listels triangulaires en essence de bois massif | Holzarten Eiche für das Möbel in glatter Ausführung und in der Ausführung mit Fronttür aus dreieckigen Massivholzleisten erhältlich | *Натуральные шпоны дуба* доступны для тумбы с гладкой поверхностью и тумбы с передней дверцей из массива бруса треугольной формы из натурального шпона дерева

● RS - Rovere Sbiancato
 ● RN - Rovere Naturale
 ● RN - Rovere Nero
 ● RT - Rovere Tinto Noce

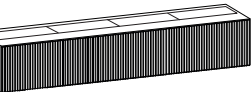
Delfo 226 ceramic top

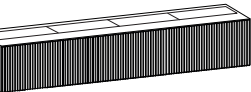
cielo

	Size (cm) Medidas Dimensions Maße Размеры	Product code Artículo Article Artikel Артикул	Net weight (Kg) Peso neto Poids net Reingewicht вес нетто	Finishes Acabados Finitions Farbe Отделка	Euro Евро
 <p>Ceramic rectangular countertop \ Top en cerámica \ Plan en céramique \ Platte aus Keramik \ керамическая столешница</p> <p>!</p> <p>N.B. Tap/Faucet hole on request (mandatory position – see technical data sheet and order form). \ Orificio grifo a petición (posición obligada-veáse ficha técnica y módulo de pedido) \ N.B. : Trou de robinet sur demande (position obligée – voir fiche technique et bon de commande) \ Hinweis: Hahnloch auf Anfrage (Position obligatorisch – siehe technisches Datenblatt und Bestellformular) \ P.S. Отверстие под смеситель по запросу (возможное место расположения отверстия – проверьте на технической карте изделия и модуле заказа)</p>	113 x 48 x h 3	DEPIR(X)* DEPIRSF(X)* no tap hole sin agujero sans orifice ohne Loch без отверстия		<ul style="list-style-type: none">  Gloss White  Gloss Black  FU - Fumo  TP - Talpa  Le Terre di Cielo  Le Acque di Cielo 	425,00 638,00 638,00 638,00 638,00 638,00
 <p>Lacquered cabinet Mueble lacado \ Meuble laqué \ Möbel lackiert \ Тумба крашенная</p> <p>!</p>	226 x 50 x h 43,5	DECR226L(X)*		<ul style="list-style-type: none">  Le Terre di Cielo *  Le Acque di Cielo  FU - Fumo  TP - Talpa 	3267,00 3758,00 3758,00 3758,00
 <p>Cabinet in wooden finish Mueble en madera \ Meuble bois \ Möbel aus Holz \ Тумба в деревянной отделке</p> <p>!</p>	226 x 50 x h 43,5	DECR226E(X)*		<ul style="list-style-type: none">  EsSENze Rovere •  *X = EU - Eucalipto 	4287,00 4722,00
 <p>Cabinet with front drawer in solid triangular wooden strips Mueble con frontal de cajón en listones triangulares de madera maciza en madera \ Armoire avec façade de tiroir en bandes de bois massif triangulaires en essence \ Möbel mit Frontschublade aus dreieckigen Massivholzleisten \ Тумба с вертикальными планками из цельного дерева на фасаде</p> <p>!</p>	226 x 50 x h 43,5	DECRD226E(X)*		<ul style="list-style-type: none">  EsSENze Rovere •  *X = EU - Eucalipto 	7896,00 8583,00

**mandatory combination:
on top Cielo washbasin +
top + cabinet with holes**

combinación obligatoria: cubeta de apoyo Cielo + encimera + mueble los agujeros \ combinación obligatoria: vasque à poser Cielo + plan + meuble con orifice \ obligatorische Kombination: Aufsatzbecken Cielo + Holzregal + Möbel mit Hahnloch \ обязательное сочетание: Накладная Cielo + столешница + Тумба с отверстиями

Technical symbols legend
 Símbolos técnicos clave
 / Légende symboles techniques / Technische Zeichenerklärung
 / Перечень технических символов

 **all sides are enamelled**
 con todos los lados esmaltados
 avec tous les côtés émaillés
 alle Seiten glasiert
 все стороны покрыты эмалью

 **no tap holes**
 sin agujero para grifo
 sans orifice robinet
 ohne Hahnloch
 без отверстия под смеситель

 **without overflow**
 sin rebosadero
 sans trop-plein
 ohne Überlauf
 без слива-перелива





































 **on top installation**
 instalación de apoyo
 installation à partir du plan
 Montage auf Platte
 установка на столешницу

Delfo 226

ceramic top

drains and siphons | desagües y sifones | les drains et les siphons |
Ablaufgarnituren und Siphons | Донные клапаны и сифоны

cielo

	Product code Artículo Article Artikel Артикул	Net weight (Kg) Peso neto Poids net Reingewicht вес нетто	Finishes	Euro Евро
 <p>Universal click/clack drain in CHROME with ceramic lid Válvula universal click/clack Cromado con tapa en cerámica \ Bonde universelle clic/clac Chromé avec clapet en céramique \ Universal-Ablaufgarnitur Click-Clack Chrom mit Keramikstopfen \ Универсальный донный клапан click/clack хром с керамической крышкой</p>	PIL01(X)*	0,40	<ul style="list-style-type: none">  Gloss White  Gloss Black  FU - Fumo  TP - Talpa  Le Terre di Cielo  Le Acque di Cielo 	<p>95,00</p> <p>114,00</p> <p>139,00</p> <p>139,00</p> <p>139,00</p> <p>139,00</p>
 <p>Universal click/clack drain in BLACK MATT finish with ceramic lid Válvula universal click/clack Negro Matt con tapa en cerámica \ Bonde universelle clic/clac Noir Matt avec clapet en céramique \ Universal-Ablaufgarnitur Click-Clack Matt Schwarz mit Keramikstopfen \ Универсальный донный клапан click/clack черный матовый с керамической крышкой</p>	PIL01NM(X)*	0,40	<ul style="list-style-type: none">  Gloss White  Gloss Black  FU - Fumo  TP - Talpa  Le Terre di Cielo  Le Acque di Cielo 	<p>120,00</p> <p>159,00</p> <p>169,00</p> <p>169,00</p> <p>169,00</p> <p>169,00</p>
 <p>Universal click/clack drain in CEMENTO finish with ceramic lid Válvula universal click/clack Cemento con tapa en cerámica \ Bonde universelle clic/clac Cemento avec clapet en céramique \ Universal-Ablaufgarnitur Click-Clack Cement mit Keramikstopfen \ Универсальный донный клапан click/clack с керамической крышкой</p>	PIL01CM(X)*	0,40	<ul style="list-style-type: none">  Gloss White  Gloss Black  FU - Fumo  TP - Talpa  Le Terre di Cielo  Le Acque di Cielo 	<p>120,00</p> <p>159,00</p> <p>169,00</p> <p>169,00</p> <p>169,00</p> <p>169,00</p>
 <p>Universal click/clack drain in BRONZE with ceramic lid Válvula universal click/clack Bronce con tapa en cerámica \ Bonde universelle clic/clac Bronze avec clapet en céramique \ Universal-Ablaufgarnitur Click-Clack Bronze mit Keramikstopfen \ Универсальный донный клапан click/clack бронза с керамической крышкой</p>	PIL01BR(X)*	0,40	<ul style="list-style-type: none">  Gloss White  Gloss Black  FU - Fumo  TP - Talpa  Le Terre di Cielo  Le Acque di Cielo 	<p>135,00</p> <p>171,00</p> <p>182,00</p> <p>182,00</p> <p>182,00</p> <p>182,00</p>
 <p>CHROMED siphon Sifone Cromado \ Siphon Chromé \ Siphon Verchromt \ сифон Chrome</p>	SISP	0,93	<ul style="list-style-type: none">  Chrome 	133,00
 <p>MATT BLACK siphon Sifone Negro Mate \ Siphon Noir Mat \ Siphon Schwarz Matt \ сифон Черный матовый</p>	SIFN	0,93	<ul style="list-style-type: none">  Matt Black 	194,00
 <p>CEMENTO siphon Sifone Cemento \ Siphon Cemento \ Siphon Cemento \ сифон Cemento</p>	SIFCM	0,93	<ul style="list-style-type: none">  Cemento 	194,00
 <p>BRONZE siphon Sifone Bronce \ Siphon Bronce \ Siphon Bronce \ бронза сифон</p>	SIFBR	0,93	<ul style="list-style-type: none">  Bronze 	220,00





Terre di Cielo available for washbasins and ceramic shelf | Terre di Cielo disponibles para el lavabo y la encimera de cerámica | Terre di Cielo disponibles pour le lavabo et le plan en céramique | Für Waschbecken und Keramikplatte erhältliche Terre di Cielo | Отделка Terre di Cielo доступны для раковины и керамических столешниц

 TL - Talco	 PM - Pomice	 BR - Brina	 BA - Basalto	 LV - Lavagna
 CM - Cemento	 FN - Fango	 CA - Cacao	 AN - Arenaria	 AV - Avena
 LN - Lino	 AG - Agave	 MU - Muschio	 PL - Polvere	 CP - Cipria
 CN - Canapa				

Acque di Cielo available for washbasins and ceramic shelf | Acque di Cielo disponibles para el lavabo y la encimera de cerámica | Acque di Cielo disponibles pour le lavabo et le plan en céramique | Für Waschbecken und Keramikplatte erhältliche Acque di Cielo | Отделка Acque di Cielo доступны для раковины и керамических столешниц

 OL - Oltremare	 SM - Smeraldo	 AL - Alga
 CO - Corallo	 NI - Ninfea	 AM - Anemone

* Terre di Cielo laquering available for cabinet | lacados Terre di Cielo disponibles para mueble | laquages Terre di Cielo disponibles pour le meuble | Für Möbel erhältliche Lackierungen Terre di Cielo | крашенная отделка Terre di Cielo доступна для ящика и столешницы

 TL - Talco	 PM - Pomice	 BR - Brina	 BA - Basalto	 CM - Cemento
 AN - Arenaria	 MU - Muschio	 AG - Agave	 AV - Avena	

• Oak finishes available for the cabinet - a smooth version and a version with the front door in solid triangular wooden strips | Essenze Rovere disponibile para el mueble en versión lisa o versión con puerta frontal con tiras de madera maciza triangulares | Essences Chêne disponibles pour le meuble en version lisse et en version avec porte frontale ornée de listels triangulaires en essence de bois massif | Holzarten Eiche für das Möbel in glatter Ausführung und in der Ausführung mit Fronttür aus dreieckigen Massivholzleisten erhältlich | Натуральные шпоны дуба доступны для тумбы с гладкой поверхностью и тумбы с передней дверцей из массива бруса треугольной формы из натурального шпона дерева

 RS - Rovere Sbiancato	 RN - Rovere Naturale
 RT - Rovere Tinto Noce	 RO - Rovere Nero

Delfo 226 ceramic top

cielo

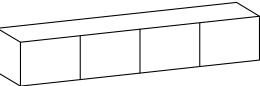
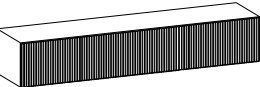
	Size (cm) Medidas Dimensions Maße Размеры	Product code Artículo Article Artikel Артикул	Net weight (kg) Peso neto Poids net Reingewicht вес нетто	Finishes Acabados Finitions Farbe Отделки	Euro Евро
 <p>Lacquered cabinet without holes Mueble lacado sin agujero \ Meuble laqué sans orifice \ Möbel lackiert ohne Hahnloch \ Тумба крашенная без отверстия</p>	226 x 50 x h 43,5	DECR226LSF(X)*		<p>● Le Terre di Cielo *</p> <p>● Le Acque di Cielo</p> <p>● FU - Fumo</p> <p>● TP - Talpa</p>	<p>3267,00</p> <p>3758,00</p> <p>3758,00</p> <p>3758,00</p>
				<p>Cabinet in wooden finish without holes Mueble en madera sin agujero \ Meuble bois sans orifice \ Möbel aus Holz ohne Hahnloch \ Тумба в деревянной отделке без отверстия</p>	226 x 50 x h 43,5
 <p>Cabinet with front drawer in solid triangular wooden strips without holes Mueble con frontal de cajón en listones triangulares de madera maciza en madera sin agujero \ Armoire avec façade de tiroir en bandes de bois massif triangulaires en essence sans orifice \ Möbel mit Frontschublade aus dreieckigen Massivholzleisten ohne Hahnloch \ Тумба с вертикальными планками из цельного дерева на фасаде, без отверстия</p>	226 x 50 x h 43,5	DECRD226ESF(X)*		<p>● Essenze Rovere •</p>	7896,00
					<p>● *X = EU - Eucalipto</p>

* Terre di Cielo laquering available for cabinet / lacados Terre di Cielo disponibles para mueble / laquages Terre di Cielo disponibles pour le meuble / Für Möbel erhältliche Lackierungen Terre di Cielo / крашенная отделка Terre di Cielo доступна для ящика и столешницы

- TL - Talco
- PM - Pomice
- BR - Brina
- BA - Basalto
- CM - Cemento
- AN - Arenaria
- MU - Muschio
- AG - Agave
- AV - Avena

● Oak finishes available for the cabinet - a smooth version and a version with the front door in solid triangular wooden strips / Essenze Rovere disponible para el mueble en versión lisa o versión con puerta frontal con tiras de madera maciza triangulares / Essences Chêne disponibles pour le meuble en version lisse et en version avec porte frontale ornée de listels triangulaires en essence de bois massif / Holzarten Eiche für das Möbel in glatter Ausführung und in der Ausführung mit Fronttür aus dreieckigen Massivholzleisten erhältlich / Натуральные шпоны дуба доступны для тумбы с гладкой поверхностью и тумбы с передней дверцей из массива бруса треугольной формы из натурального шпона дерева

















































- RS - Rovere Sbiancato
- RN - Rovere Naturale
- RT - Rovere Tinto Noce
- RO - Rovere Nero



Le Bacinelle

bowls available on Delfo rectangular top

























































cielo

	Size (cm) Medidas Dimensions Maße Размеры	Product code Artículo Article Artikel Артикул	Net weight (Kg) Peso neto Poids net Reingewicht вес нетто	Finishes Acabados Finitions Farbe Отделки	Euro Евро	Pz. шт. pallet Italia	Pz. шт. pallet Cont.
  <p>Round on top bowl Catino ø45 Cubela de apoio Catino ronda ø45 / Vasque à poser Catino tour ø45 / Aufsatzbecken Runde Catino ø45 / Раковина круглый Catino ø45</p>	ø45 x h 16	CALAT45(X)*	9,00	<ul style="list-style-type: none">  Gloss White  Gloss Black  FU - Fumo  TP - Talpa  Le Terre di Cielo  Le Acque di Cielo 	643,00 815,00 815,00 815,00 815,00 815,00	20	30
  <p>Oval on top bowl Catino 55 Cubela de apoio Catino Oval 55 / Vasque à poser Catino Oval 55 / Aufsatzbecken Oval Catino 55 / Раковина овальный Catino 55</p>	55 x 42 x h 16	CALA055(X)*	10,00	<ul style="list-style-type: none">  Gloss White  Gloss Black  FU - Fumo  TP - Talpa  Le Terre di Cielo  Le Acque di Cielo 	688,00 896,00 896,00 896,00 896,00 896,00	14	21
  <p>Round Theo washbasin Lavabo Theo ronda \ Lavabo Theo tour \ Aufsatzbecken Runde Theo \ Theo Раковина круглый</p>	ø40 x 16 h	THLAT(X)*	8,50	<ul style="list-style-type: none">  Gloss White  Gloss Black  FU - Fumo  TP - Talpa  Le Terre di Cielo  Le Acque di Cielo 	457,00 723,00 723,00 723,00 723,00 723,00	24	48
  <p>Oval Theo washbasin Lavabo Theo oval \ Lavabo Theo ovale \ Aufsatzbecken Oval Theo \ Раковина овальный Theo</p>	55 x 40 x 16 h	THLAO(X)*	10,50	<ul style="list-style-type: none">  Gloss White  Gloss Black  FU - Fumo  TP - Talpa  Le Terre di Cielo  Le Acque di Cielo 	688,00 896,00 896,00 896,00 896,00 896,00	14	21
  <p>On top bowl h19 Tina Cubela de apoio h19 Tina \ Vasque à poser h19 Tina Aufsatzbecken h19 Tina \ Накладная чаша h19 Tina</p>	ø43 x 19 h	BATO(X)*	10,30	<ul style="list-style-type: none">  Gloss White  Gloss Black  FU - Fumo  TP - Talpa  Le Terre di Cielo  Le Acque di Cielo 	427,00 697,00 697,00 697,00 697,00 697,00	26	52
  <p>On top bowl h26 Tina Cubela de apoio h26 Tina \ Vasque à poser h26 Tina Aufsatzbecken h26 Tina \ Накладная чаша h26 Tina</p>	ø45 x 26 h	BATA(X)*	11,90	<ul style="list-style-type: none">  Gloss White  Gloss Black  FU - Fumo  TP - Talpa  Le Terre di Cielo  Le Acque di Cielo 	638,00 832,00 832,00 832,00 832,00 832,00	16	32

Le Bacinelle

bowls available on Delfo rectangular top











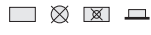



















cielo

	Size (cm)	Product code	Net weight (Kg)	Finishes	Euro	Pz.	Pz.
	Medidas Dimensions Maße Размеры	Artículo Article Artikel Артикул	Peso neto Poids net Reingewicht вес нетто	Acabados Finitions Farbe Отделки	Евро	шт. pallet Italia	шт. pallet Cont.
  <p>Round on top bowl Era ø45 Cubela de apoio Era ronda ø45 / Vasque à poser Era tour ø45 / Aufsatzbecken Runde Era ø45 / Раковина круглый Era ø45</p>	ø45 x 24 h	BAERA(X)*	13,00	<ul style="list-style-type: none">  Gloss White 667,00  Gloss Black 934,00  FU - Fumo 934,00  TP - Talpa 934,00  Le Terre di Cielo 934,00  Le Acque di Cielo 934,00 	667,00	16	32
  <p>Era Small on top bowl Cubela de apoio Era Small / Vasque à poser Era Small / Aufsatzbecken Runde Era Small / Раковина круглый Era Small</p>	ø40 x 15 h	BAERA40(X)*	8,00	<ul style="list-style-type: none">  Gloss White 424,00  Gloss Black 690,00  FU - Fumo 690,00  TP - Talpa 690,00  Le Terre di Cielo 690,00  Le Acque di Cielo 690,00 	424,00	26	52
  <p>Oval on top bowl Eco 62 Cubela de apoio Eco oval 62 / Vasque à poser Eco ovale 62 / Aufsatzbecken Oval Eco 62 / Раковина овальный Eco 62</p>	62 x 45 x 18 h	BAECO(X)*	10,50	<ul style="list-style-type: none">  Gloss White 601,00  Gloss Black 840,00  FU - Fumo 840,00  TP - Talpa 840,00  Le Terre di Cielo 840,00  Le Acque di Cielo 840,00 	601,00	14	28
  <p>Eco Small on top bowl Cubela de apoio Eco Small / Vasque à poser Eco Small / Aufsatzbecken Runde Eco Small / Раковина круглый Eco Small</p>	58 x 42 x 16,5 h	BAECO58(X)*	10,00	<ul style="list-style-type: none">  Gloss White 534,00  Gloss Black 788,00  FU - Fumo 788,00  TP - Talpa 788,00  Le Terre di Cielo 788,00  Le Acque di Cielo 788,00 	534,00	16	32
  <p>Handy round on top bowl with one hole Lavabo Handy ronda con 1 agujero ø45 / Lavabo Handy tour tour monotrou ø45 / Aufsatzbecken Runde Handy ø45 1-Loch / Раковина круглый Handy ø45 одно отверстие под смеситель</p>	ø45 x 17 h	HALAT45(X)* HALAT45SF(X)* no tap hole sin agujero sans orifice ohne Loch без отверстия	10,50	<ul style="list-style-type: none">  Gloss White 456,00  Gloss Black 714,00  FU - Fumo 714,00  TP - Talpa 714,00  Le Terre di Cielo 714,00  Le Acque di Cielo 714,00 	456,00	20	34
  <p>Round on top washbasin 45 Mare Lavabo de apoio Ronda 45 / Lavabo à poser Tour 45 / Aufsatzbecken Waschtisch Runde 45 / Раковина круглый 45</p>	ø45 x h15	MRLAT(X)*	9,00	<ul style="list-style-type: none">  Gloss White 446,00  Gloss Black 701,00  FU - Fumo 701,00  TP - Talpa 701,00  Le Terre di Cielo 701,00  Le Acque di Cielo 701,00 	446,00	20	30
  <p>Oval on top washbasin 60 Mare Lavabo à poser oval 60 / Lavabo de apoyo ovale 60 / Aufsatzbecken Waschtisch Oval 60 / Раковина овальный 60</p>	60 x 38 x h15	MRLAO(X)*	12,00	<ul style="list-style-type: none">  Gloss White 541,00  Gloss Black 851,00  FU - Fumo 851,00  TP - Talpa 851,00  Le Terre di Cielo 851,00  Le Acque di Cielo 851,00 	541,00	20	40

Le Bacinelle









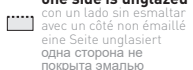

bowls available on Delfo rectangular top

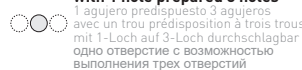
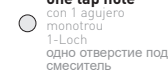
cielo

	Size (cm) Medidas Dimensions Maße Размеры	Product code Artículo Article Artikel Артикул	Net weight (Kg) Peso neto Poids net Reingewicht вес нетто	Finishes Acabados Finitions Farbe Отделки	Euro Евро	Pz. шт. pallet Italia	Pz. шт. pallet Cont.
  <p>On top bowl without overflow ø40 Cubela de apoyo sin demasiado lleno ø40 Vasque à poser sans trop plein ø40 Aufsatzbecken ohne Überlauf ø40 Накладная чаша без переливом ø40</p>	ø40 x 18,5 h	SHBA40(X)*	8,55	<ul style="list-style-type: none">  Gloss White  *X = N - Gloss Black  FU - Fumo  TP - Talpa  Le Terre di Cielo  Le Acque di Cielo 	427,00 521,00 708,00 708,00 708,00 708,00	26	52
  <p>On top bowl without overflow ø45 Cubela de apoyo sin demasiado lleno ø45 Vasque à poser sans trop plein ø45 Aufsatzbecken ohne Überlauf ø45 Накладная чаша без переливом ø45</p>	ø45 x 12,5 h	SHBA45(X)*	9,05	<ul style="list-style-type: none">  Gloss White  *X = N - Gloss Black  FU - Fumo  TP - Talpa  Le Terre di Cielo  Le Acque di Cielo 	433,00 532,00 744,00 744,00 744,00 744,00	32	64
  <p>Shui Comfort oval washbasin 60 x 38 Lavabo Shui Comfort oval 60 x 38 Lavabo Shui Comfort ovale 60 x 38 Aufsatzbecken Oval Shui Comfort 60 x 38 Раковина овальный Shui Comfort 60 x 38</p>	60 x 38 x 12,5 h	SHCOLA060(X)*	9,60	<ul style="list-style-type: none">  Gloss White  *X = N - Gloss Black  FU - Fumo  TP - Talpa  Le Terre di Cielo  Le Acque di Cielo 	542,00 723,00 852,00 852,00 852,00 852,00	20	40
  <p>Shui Comfort round washbasin 40 Lavabo Shui Comfort ronda 40 Lavabo Shui Comfort tour 40 Aufsatzbecken Runde Shui Comfort 40 Раковина круглый Shui Comfort 60 x 40</p>	40 x 40 x 12,5 h	SHCOLAT40(X)*	6,85	<ul style="list-style-type: none">  Gloss White  *X = N - Gloss Black  FU - Fumo  TP - Talpa  Le Terre di Cielo  Le Acque di Cielo 	434,00 446,00 710,00 710,00 710,00 710,00	26	52

Technical symbols legend







Simbolos técnicos clave / Légende symboles techniques / Technische Zeichenerklärung / Перечень технических символов

 <p>one side is unglazed con un lado sin esmaltar avec un côté non émaillé eine Seite unglasiert одна сторона не покрыта эмалью</p>	 <p>all sides are enamelled con todos los lados esmaltados avec tous les côtés émaillés alle Seiten glasiert все стороны покрыты эмалью</p>	 <p>with 1 hole prepared 3 holes 1 agujero predisposto 3 agujeros avec un trou prédisposition à trois trous mit 1-Loch auf 3-Loch durchschlagbar одно отверстие с возможностью выполнения трех отверстий</p>	 <p>one tap hole con 1 agujero monotrou 1-Loch одно отверстие под смеситель</p>	 <p>no tap hole on request sin agujero, solo a petición sans orifice sur demande auf Anfrage ohne Loch без отверстия под смеситель по запросу</p>	 <p>without overflow sin rebosadero sans trop-plein ohne Überlauf без слива-перелива</p>
 <p>on top installation instalación de apoyo installation à partir du plan Montage auf Platte установка на столешницу</p>	 <p>wall-hung installation instalación suspendida installation suspendue wandhängende Montage подвесная установка</p>	 <p>with fixing parts fijaciones incluidas fixations incluses inklusive Befestigungen в комплекте с крепежами</p>	 <p>no tap holes sin agujero para grifo sans orifice robinet ohne Hahnloch без отверстия под смеситель</p>	 <p>with overflow con rebosadero avec trop-plein mit Überlauf с переливом</p>	

Terre di Cielo

 TL - Talco	 PM - Pomice	 BR - Brina	 BA - Basalto	 LV - Lavagna
 CM - Cemento	 FN - Fango	 CA - Cacao	 AN - Arenaria	 AV - Avena
 LN - Lino	 AG - Agave	 MU - Muschio	 PL - Polvere	 CP - Cipria
 CN - Canapa				





































Acque di Cielo

 OL - Oltremare	 SM - Smeraldo	 AL - Alga
 CO - Corallo	 NI - Ninfea	 AM - Anemone

Le Bacinelle

cielo

drains and siphons | desagües y sifones | les drains et les siphons | Ablaufgarnituren und Siphons | Донные клапаны и сифоны

	Product code Artículo Article Artikel Артикул	Net weight (Kg) Peso neto Poids net Reingewicht вес нетто	Finishes Acabados Finitions Farbe Отделки	Euro Euro
 <p>Universal click/clack drain in CHROME with ceramic lid Válvula universal click/clack Cromado con tapa en cerámica Bonde universelle clic/clac Chromé avec clapet en céramique Universal-Abflussgarnitur Click-Clack Chrom mit Keramikstopfen Универсальный донный клапан click/clack хром с керамической крышкой</p>	PIL01(X)*	0,40	<ul style="list-style-type: none">  Gloss White  *X = N - Gloss Black  *X = FU - Fumo  *X = TP- Talpa  Le Terre di Cielo  Le Acque di Cielo 	<p>95,00</p> <p>114,00</p> <p>139,00</p> <p>139,00</p> <p>139,00</p> <p>139,00</p>
 <p>Universal click/clack drain in BLACK MATT finish with ceramic lid / Válvula universal click/clack Negro Matt con tapa en cerámica Bonde universelle clic/clac Noir Mat avec clapet en céramique / Universal-Abflussgarnitur Click-Clack Matt Schwarz mit Keramikstopfen / Универсальный донный клапан click/clack черный матовый с керамической крышкой</p>	PIL01NM(X)*	0,40	<ul style="list-style-type: none">  Gloss White  *X = N - Gloss Black  *X = FU - Fumo  *X = TP- Talpa  Le Terre di Cielo  Le Acque di Cielo 	<p>120,00</p> <p>159,00</p> <p>169,00</p> <p>169,00</p> <p>169,00</p> <p>169,00</p>
 <p>Universal click/clack drain in CEMENTO finish with ceramic lid / Válvula universal click/clack Cemento con tapa en cerámica Bonde universelle clic/clac Cemento avec clapet en céramique / Universal-Abflussgarnitur Click-Clack Cement mit Keramikstopfen Универсальный донный клапан click/clack с керамической крышкой</p>	PIL01CM(X)*	0,40	<ul style="list-style-type: none">  Gloss White  *X = N - Gloss Black  *X = FU - Fumo  *X = TP- Talpa  Le Terre di Cielo  Le Acque di Cielo 	<p>120,00</p> <p>159,00</p> <p>169,00</p> <p>169,00</p> <p>169,00</p> <p>169,00</p>
 <p>Universal click/clack drain in BRONZE with ceramic lid Válvula universal click/clack Bronce con tapa en cerámica Bonde universelle clic/clac Bronze avec clapet en céramique Universal-Abflussgarnitur Click-Clack Bronze mit Keramikstopfen Универсальный донный клапан click/clack бронза с керамической крышкой</p>	PIL01BR(X)*	0,40	<ul style="list-style-type: none">  Gloss White  *X = N - Gloss Black  *X = FU - Fumo  *X = TP- Talpa  Le Terre di Cielo  Le Acque di Cielo 	<p>135,00</p> <p>171,00</p> <p>182,00</p> <p>182,00</p> <p>182,00</p> <p>182,00</p>
 <p>CHROMED siphon Sifone Cromado \ Siphon Chromé \ Siphon Verchromt \ сифон Chrome</p>	SISP	0,93	<ul style="list-style-type: none">  Chrome 	133,00
 <p>MATT BLACK siphon Sifone Negro Mate \ Siphon Noir Mat \ Siphon Schwarz Matt \ Сифон Черный матовый</p>	SIFN	0,93	<ul style="list-style-type: none">  Matt Black 	194,00
 <p>CEMENTO siphon Sifone Cemento \ Siphon Cemento \ Siphon Cemento \ сифон Cemento</p>	SIFCM	0,93	<ul style="list-style-type: none">  Cemento 	194,00
 <p>BRONZE siphon Sifone Bronce \ Siphon Bronze \ Siphon Bronze \ бронза сифон</p>	SIFBR	0,93	<ul style="list-style-type: none">  Bronze 	220,00

CERAMICA CIELO SpA
Via Falerina km 7800
01034 - Fabrica di Roma (VT)
t +39 0761 56701 / f +39 0761 540363
info@ceramicacielo.it
www.ceramicacielo.it

SPAZIO CIELO
Via Pontaccio 4 / 6
20121 - Milano Italy
t +39 0239661165

CIELO SOHO
109 Greene Street, Suite 1D
New York - NY 10012
t 646 9302268